

Standard Rectifier Module

1~ Rectifier	
$V_{RRM} =$	800 V
$I_{DAV} =$	14 A
$I_{FSM} =$	380 A

1~ Rectifier Bridge

Part number

VBO22-08NO8

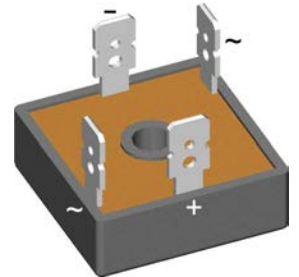

 E72873

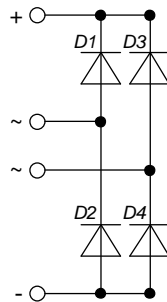

Features / Advantages:

- Planar passivated chips
- Very low leakage current
- Very low forward voltage drop
- Improved thermal behaviour

Applications:

- Diode for main rectification
- For one phase bridge configurations
- Supplies for DC power equipment
- Input rectifiers for PWM inverter
- Battery DC power supplies
- Field supply for DC motors

Package: FO-B

- Isolation Voltage: 3000 V~
- Industry standard outline
- RoHS compliant
- ¼" fast-on terminals
- Easy to mount with one screw

Disclaimer Notice

Information furnished is believed to be accurate and reliable. However, users should independently evaluate the suitability of and test each product selected for their own applications. Littelfuse products are not designed for, and may not be used in, all applications. Read complete Disclaimer Notice at www.littelfuse.com/disclaimer-electronics.



Rectifier				Ratings			
Symbol	Definition	Conditions		min.	typ.	max.	Unit
V_{RSM}	max. non-repetitive reverse blocking voltage					900	V
V_{RRM}	max. repetitive reverse blocking voltage					800	V
I_R	reverse current	$V_R = 800\text{ V}$	$T_{VJ} = 25^\circ\text{C}$			40	μA
		$V_R = 800\text{ V}$	$T_{VJ} = 150^\circ\text{C}$			1,5	mA
V_F	forward voltage drop	$I_F = 10\text{ A}$	$T_{VJ} = 25^\circ\text{C}$			1,05	V
		$I_F = 20\text{ A}$				1,15	V
		$I_F = 10\text{ A}$	$T_{VJ} = 125^\circ\text{C}$			0,94	V
		$I_F = 20\text{ A}$				1,08	V
I_{DAV}	bridge output current	$T_C = 85^\circ\text{C}$ rectangular	$T_{VJ} = 150^\circ\text{C}$			14	A
V_{FO}	threshold voltage	} for power loss calculation only				0,77	V
r_F	slope resistance					14,2	m Ω
R_{thJC}	thermal resistance junction to case					8	K/W
R_{thCH}	thermal resistance case to heatsink				1		K/W
P_{tot}	total power dissipation			$T_C = 25^\circ\text{C}$		15	W
I_{FSM}	max. forward surge current	$t = 10\text{ ms}; (50\text{ Hz}), \text{ sine}$	$T_{VJ} = 45^\circ\text{C}$			380	A
		$t = 8,3\text{ ms}; (60\text{ Hz}), \text{ sine}$	$V_R = 0\text{ V}$			410	A
		$t = 10\text{ ms}; (50\text{ Hz}), \text{ sine}$	$T_{VJ} = 150^\circ\text{C}$			325	A
		$t = 8,3\text{ ms}; (60\text{ Hz}), \text{ sine}$	$V_R = 0\text{ V}$			350	A
I^2t	value for fusing	$t = 10\text{ ms}; (50\text{ Hz}), \text{ sine}$	$T_{VJ} = 45^\circ\text{C}$			720	A ² s
		$t = 8,3\text{ ms}; (60\text{ Hz}), \text{ sine}$	$V_R = 0\text{ V}$			700	A ² s
		$t = 10\text{ ms}; (50\text{ Hz}), \text{ sine}$	$T_{VJ} = 150^\circ\text{C}$			530	A ² s
		$t = 8,3\text{ ms}; (60\text{ Hz}), \text{ sine}$	$V_R = 0\text{ V}$			510	A ² s
C_J	junction capacitance	$V_R = 400\text{ V}; f = 1\text{ MHz}$	$T_{VJ} = 25^\circ\text{C}$		10		pF

Package FO-B		Ratings				
Symbol	Definition	Conditions	min.	typ.	max.	Unit
I_{RMS}	RMS current	per terminal			100	A
T_{VJ}	virtual junction temperature		-40		150	°C
T_{op}	operation temperature		-40		125	°C
T_{stg}	storage temperature		-40		125	°C
Weight				19		g
M_D	mounting torque		1,8		2,2	Nm
$d_{Spp/App}$	creepage distance on surface striking distance through air	terminal to terminal	9,0	7,0		mm
$d_{Spb/Apb}$		terminal to backside	10,0	10,0		mm
V_{ISOL}	isolation voltage	t = 1 second	3000			V
		t = 1 minute	2500			V

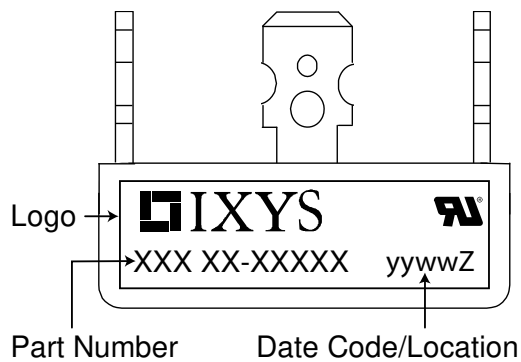

Ordering	Ordering Number	Marking on Product	Delivery Mode	Quantity	Code No.
Standard	VBO22-08NO8	VBO22-08NO8	Box	50	476943

Equivalent Circuits for Simulation

* on die level

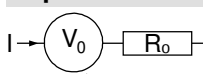
 $T_{VJ} = 150^{\circ}\text{C}$

Rectifier

$V_{0\ max}$	threshold voltage	0,77	V
$R_{0\ max}$	slope resistance *	13	mΩ

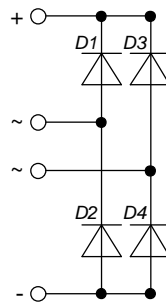
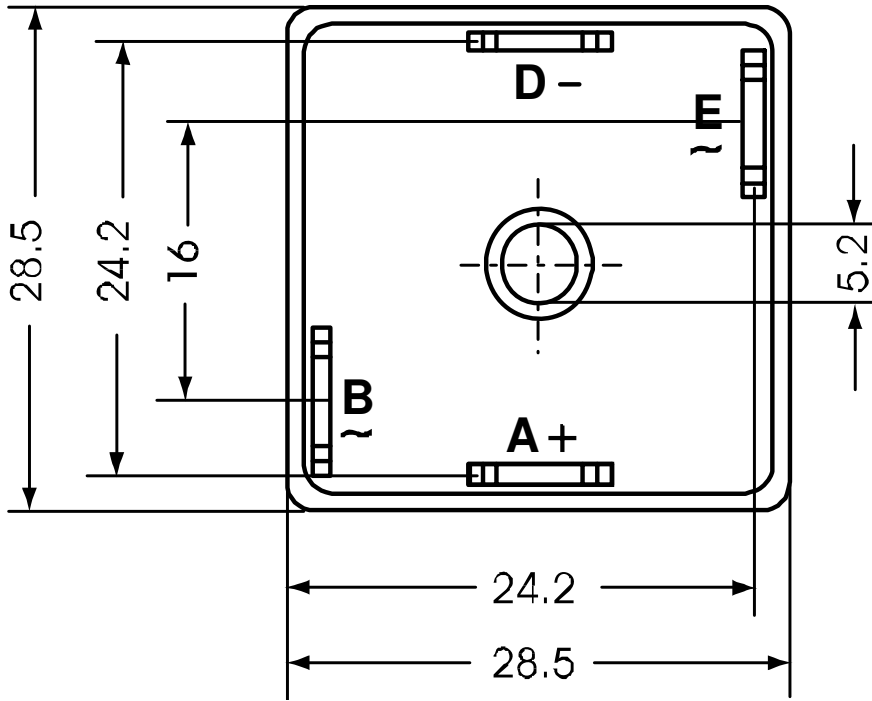
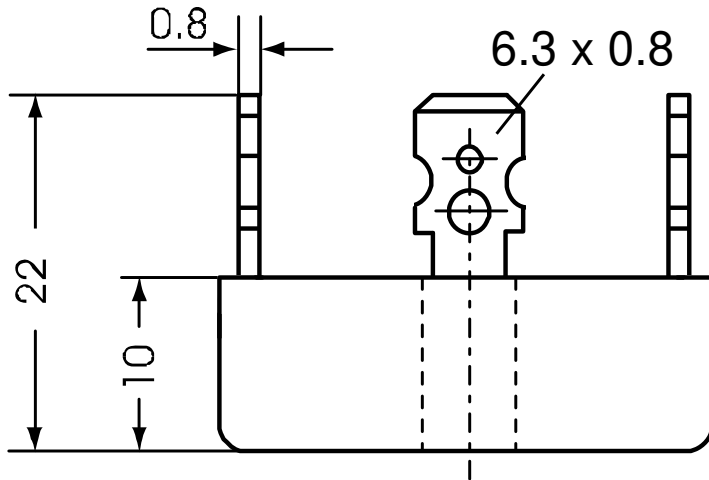

Outlines FO-B



Rectifier

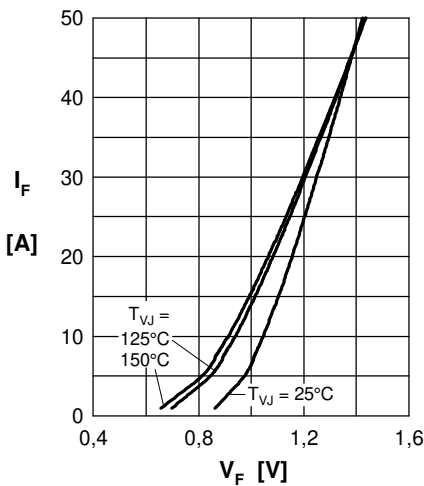

Fig. 1 Forward current vs. voltage drop per diode

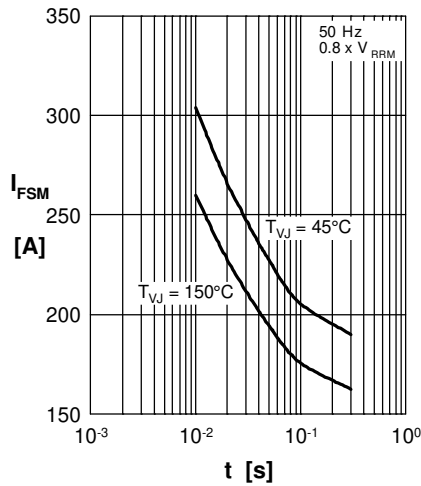

Fig. 2 Surge overload current vs. time per diode

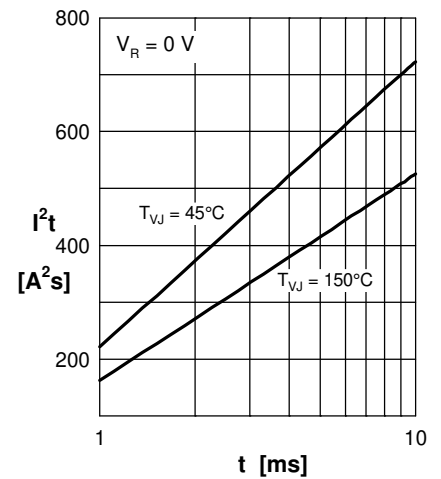

Fig. 3 I^2t vs. time per diode

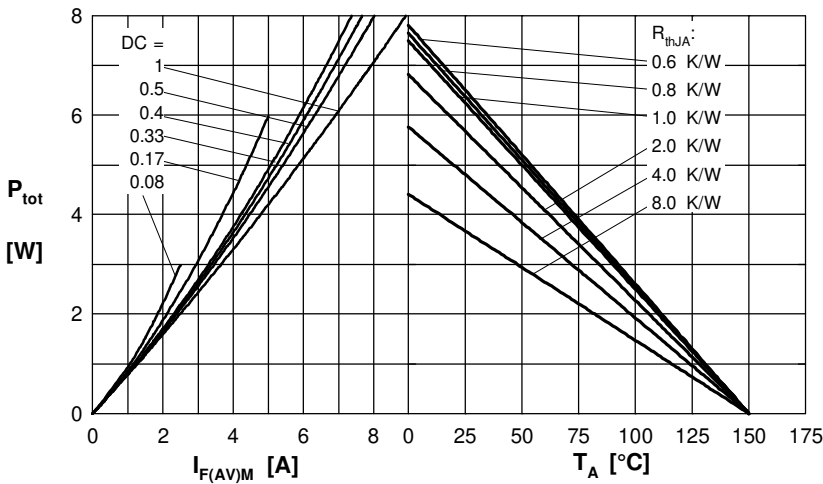

Fig. 4 Power dissipation vs. forward current and ambient temperature per diode

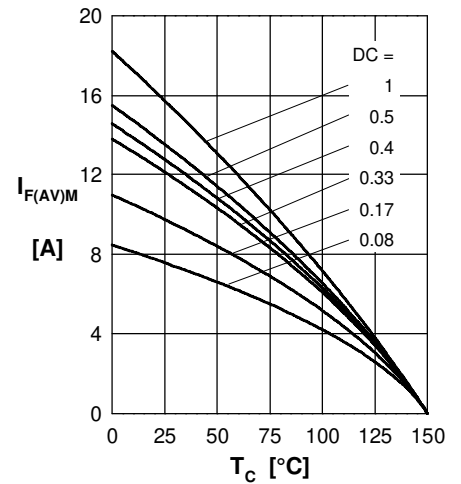

Fig. 5 Max. forward current vs. case temperature per diode

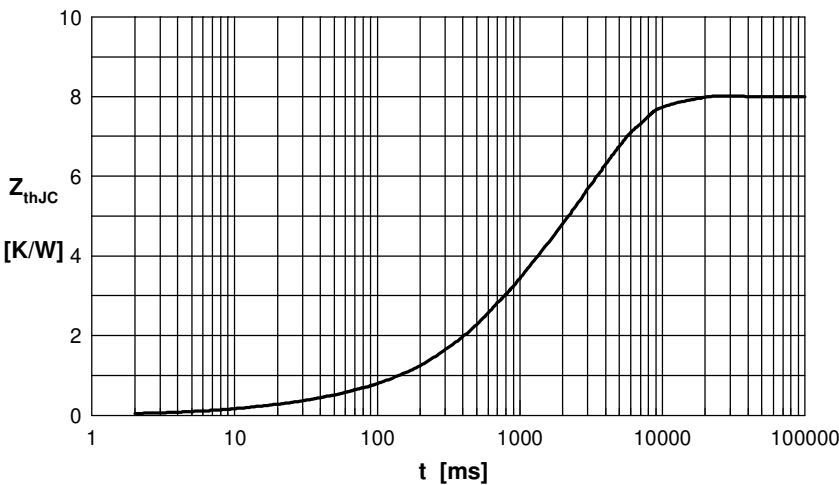

Fig. 6 Transient thermal impedance junction to case vs. time per diode

Constants for Z_{thJC} calculation:

i	R_{th} (K/W)	t_i (s)
1	0.040	0.005
2	0.250	0.030
3	1.810	0.500
4	5.900	3.200