

SZ5KASMC Series

Automotive, Surface Mount 5000 W In DO-214AB



Additional Information



Resources



Accessories



Samples

Agency Approvals

Agency	Agency File Number
	E128662

Maximum Ratings & Thermal Characteristics

Parameter	Symbol	Value	Unit
Peak Power Dissipation (Note 1) @ $T_L = 25^\circ\text{C}$, Pulse Width = 1 ms	P_{PPM}	5000	W
DC Power Dissipation @ $T_L = 75^\circ\text{C}$ Measured Zero Lead Length (Note 2) Derate Above 75°C	P_D	5.4 54.6	W $\text{mW}/^\circ\text{C}$
DC Power Dissipation (Note 3) @ $T_A = 25^\circ\text{C}$ Derate Above 25°C	P_D	2.0 13.3	W $\text{mW}/^\circ\text{C}$
Operating and Storage Temperature Range	T_J T_{stg}	-65 to +175	$^\circ\text{C}$
Thermal Resistance from Junction-to-Ambient	$R_{\theta JA}$	75	$^\circ\text{C}/\text{W}$
Thermal Resistance from Junction-to-Lead	$R_{\theta JL}$	18.3	$^\circ\text{C}/\text{W}$

Stresses exceeding maximum ratings may damage the device. Maximum ratings are stress ratings only. Functional operation above the recommended operating conditions is not implied. Extended exposure to stresses above the recommended operating conditions may affect device reliability.

1. $10 \times 1000 \mu\text{s}$, non-repetitive.
2. 1 inch square copper pad, FR-4 board.
3. FR-4 board, using Littelfuse minimum recommended footprint

Description

The SZ5KASMC series is designed to protect voltage sensitive components from high voltage, high energy transients. They have excellent clamping capability, high surge capability, low zener impedance and fast response time. The SZ5KASMC series is supplied in cost-effective, highly reliable DO-214AB package and it is ideal for use in automotive electronic applications.

Features and Benefits

- Automotive grade, AEC-Q101 qualified and PPAP capable
- Peak power – 5000 W@1 ms
- Working peak reverse voltage range - 10 V to 36 V for Bi-directional
- Standard zener breakdown voltage range - 11.1 V to 44.2 V
- Compact design in DO-214AB package
- ESD protection of data lines in accordance with IEC 61000-4-2 30 kV (Air), 30 kV (Contact)
- ESD rating of class 3 (>16 kV) per human body model
- Zener transient overvoltage suppressors
- Excellent clamping capability
- UL recognized compound meeting flammability rating V-0
- $V_{BR} @ T_J = V_{BR} @ 25^\circ\text{C} \times (1 + \alpha T \times (T_J - 25))$ (αT : Temperature coefficient, typical value is 0.1%)
- Maximum temperature coefficient specified
- Response time is typically < 1 ns
- These components are Pb-free and are ROHS compliant
- UL recognized as an isolated loop circuit protector to UL 497B

Applications

TVS devices are ideal for the protection of I/O Interfaces, V_{CC} bus and other vulnerable circuits used in automotive application.

Functional Diagram

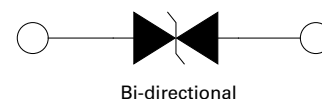

Bi-directional

SZ5KASMC Series

Automotive, Surface Mount 5000 W In DO-214AB

Electrical Characteristics

Part Number	Marking	Working Peak Reverse Voltage V_{RWM} (V) (Note 5)	Breakdown Voltage V_{BR} (V) @ I_T (Note 6)		Test Current I_T (mA)	Maximum Clamping Voltage V_C @ I_{PP} (Note 7) (V)	Maximum Peak Pulse Current I_{PP} (A)	Maximum Reverse Leakage I_R @ V_R (μ A)	Agency Approval 
			Min	Max					
SZ5KASMC10CAT3G	5BAR	10.0	11.1	12.3	1	17.0	294.1	20	X
SZ5KASMC11CAT3G	5BAT	11.0	12.2	13.5	1	18.2	274.7	20	X
SZ5KASMC12CAT3G	5BEP	12.0	13.3	14.7	1	19.9	251.3	10	X
SZ5KASMC13CAT3G	5BEQ	13.0	14.4	15.9	1	21.5	232.6	10	X
SZ5KASMC14CAT3G	5BER	14.0	15.6	17.2	1	23.2	215.5	5	X
SZ5KASMC15CAT3G	5BES	15.0	16.7	18.5	1	24.4	204.9	5	X
SZ5KASMC16CAT3G	5BET	16.0	17.8	19.7	1	26.0	192.3	5	X
SZ5KASMC17CAT3G	5BEU	17.0	18.9	20.9	1	27.6	181.2	5	X
SZ5KASMC18CAT3G	5BEV	18.0	20.0	22.1	1	29.2	171.2	5	X
SZ5KASMC20CAT3G	5BEW	20.0	22.2	24.5	1	32.4	154.3	5	X
SZ5KASMC22CAT3G	5BEX	22.0	24.4	26.9	1	35.5	140.8	5	X
SZ5KASMC24CAT3G	5BEZ	24.0	26.7	29.5	1	38.9	128.5	5	X
SZ5KASMC26CAT3G	5BFE	26.0	28.9	31.9	1	42.1	118.2	5	X
SZ5KASMC28CAT3G	5BFG	28.0	31.1	34.4	1	45.4	110.1	5	X
SZ5KASMC30CAT3G	5BFK	30.0	33.3	36.8	1	48.4	103.3	5	X
SZ5KASMC33CAT3G	5BFM	33.0	36.7	40.6	1	53.3	93.8	5	X
SZ5KASMC36CAT3G	5BFP	36.0	40.0	44.2	1	58.1	86.1	5	X

5. A transient suppressor is normally selected according to the maximum working peak reverse voltage (V_{RWM}), which should be equal to or greater than the DC or continuous peak operating voltage level.

6. V_{BR} measured at pulse test current I_T at an ambient temperature of 25 °C.

7. Surge current waveform per figure 2 and decay rate per figure 4 of the general data – 5000 watt at the beginning of this group.

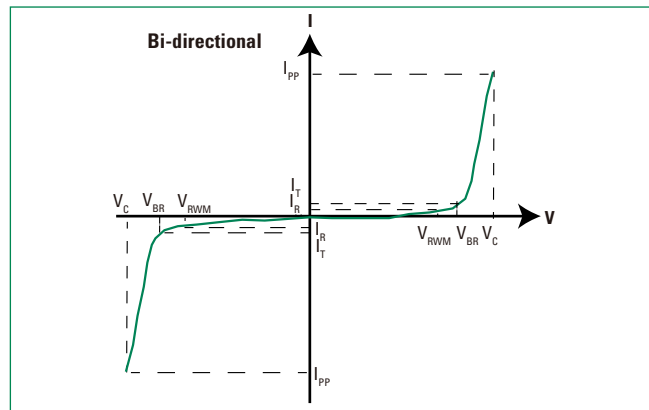
I-V Curve Characteristics (TA = 25 °C unless otherwise noted) For Bi-directional

Symbol	Parameter
I_{PP}	Maximum Reverse Peak Pulse Current
V_C	Clamping Voltage @ I_{PP}
V_{RWM}	Working Peak Reverse Voltage
I_R	Maximum Reverse Leakage Current @ V_{RWM}
V_{BR}	Breakdown Voltage @ I_T
I_T	Breakdown Current Current

SZ5KASMC Series

Automotive, Surface Mount 5000 W In DO-214AB

Figure 1. Pulse Rating Curve

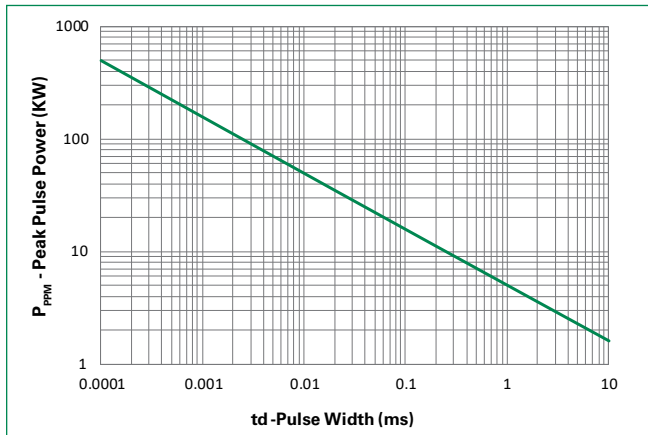

Figure 2. 10/1000 μ s Pulse Waveform

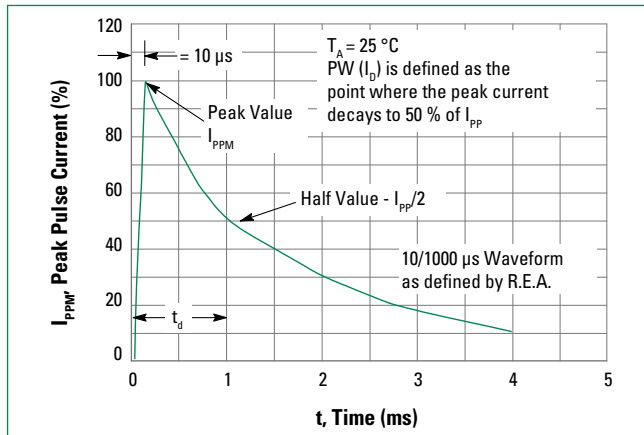

Figure 3. Typical Junction Capacitance vs. Bias Voltage

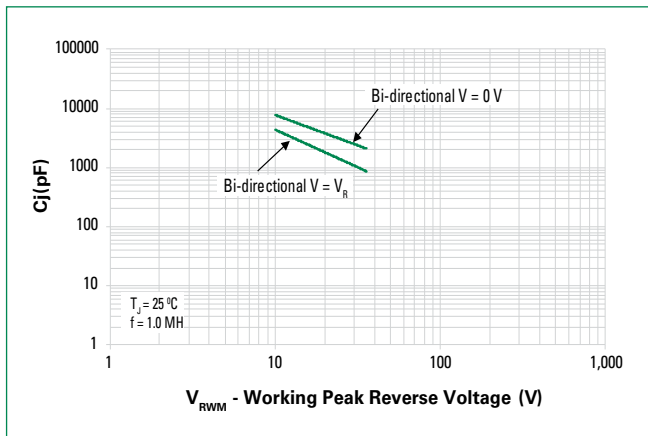
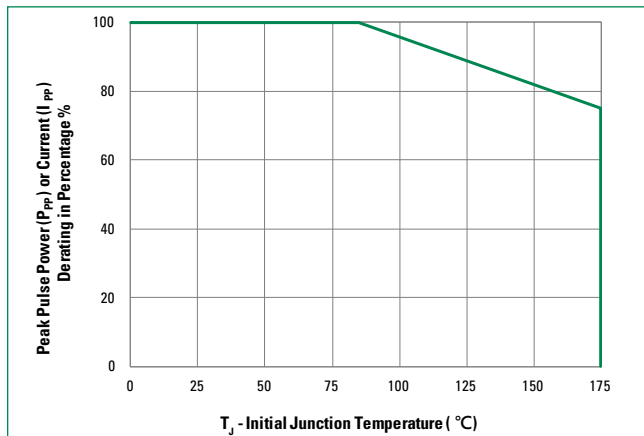

Figure 4. Surge Derating Curve



SZ5KASMC Series

Automotive, Surface Mount 5000 W In DO-214AB

Soldering Parameters

Reflow Condition		Lead-free assembly
Pre Heat	- Temperature Min ($T_{s(min)}$)	150 °C
	- Temperature Max ($T_{s(max)}$)	200 °C
	- Time (min to max) (t_s)	60 – 120 seconds
Average Ramp Up Rate (Liquidus Temp (T_L) to Peak		3 °C/second max
$T_{s(max)}$ to T_L - Ramp-up Rate		3 °C/second max
Reflow	- Temperature (T_L) (Liquidus)	217 °C
	- Time (min to max) (t_s)	60 – 150 seconds
Peak Temperature (T_p)		260 ^{+0/-5} °C
Time within 5 °C of Actual Peak Temperature (t_p)		30 seconds max
Ramp-down Rate		6 °C/second max
Time 25 °C to Peak Temperature (T_p)		8 minutes max.
Do Not Exceed		260 °C

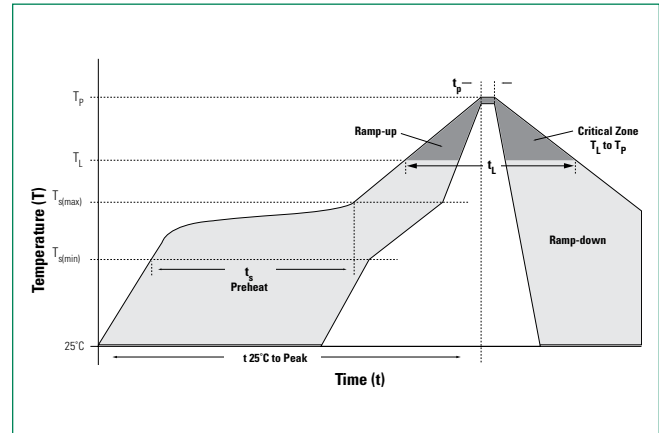

Physical Specifications

Weight	0.00733 ounce, 0.228 grams
Case	JEDEC DO-214AB. Void-free, transfer-molded, thermosetting plastic epoxy meets UL 94V-0
Polarity	Color band denotes cathode except bidirectional
Terminal	Matte Tin-plated leads, solderable per JESD22-B102

Environmental Specifications

High Temperature Storage	JESD22-A103
HTRB	JESD22-A108
Temperature Cycling	JESD22-A104
MSL	JEDEC J-STD-020, Level 1
H3TRB	JESD22-A101
RSH	JESD22-A111

Dimensions

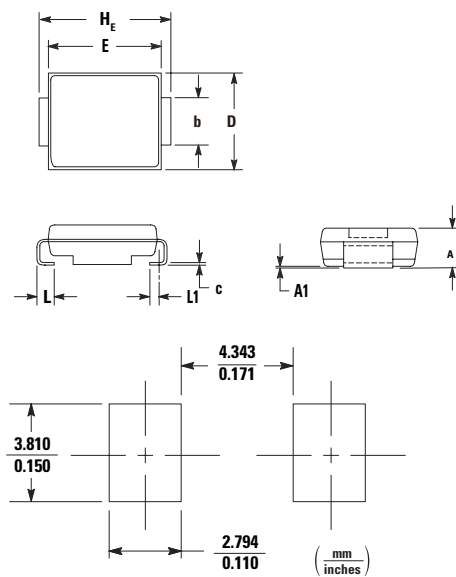

Soldering Footprint

Dim	Inches			Millimeters		
	Min	Nom	Max	Min	Nom	Max
A	0.079	0.087	0.095	2.00	2.22	2.41
A1	0.002	0.004	0.008	0.05	0.10	0.20
b	0.115	0.118	0.125	2.92	3.00	3.18
c	0.006	0.009	0.012	0.15	0.23	0.30
D	0.220	0.230	0.240	5.59	5.84	6.10
E	0.260	0.270	0.280	6.60	6.86	7.11
H _E	0.305	0.313	0.320	7.75	7.94	8.13
L	0.030	0.040	0.050	0.76	1.02	1.27
L1	0.020 REF			0.51 REF		

Ordering Information

Device	Package	Shipping
SZ5KASMCxxCAT3G	SMC (Pb-Free)	2,500 / Tape & Reel

SZ5KASMC Series

Automotive, Surface Mount 5000 W In DO-214AB

Part Numbering System

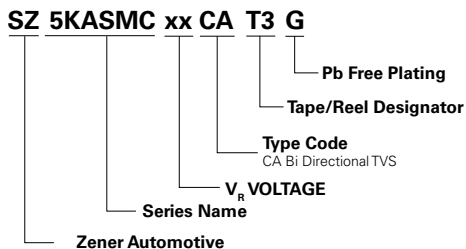

Part Marking System

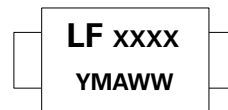

XXXX = Marking Code
Y = Year
M = Month
A = Assembly Location
WW = Lot Code

Tape and Reel Specification

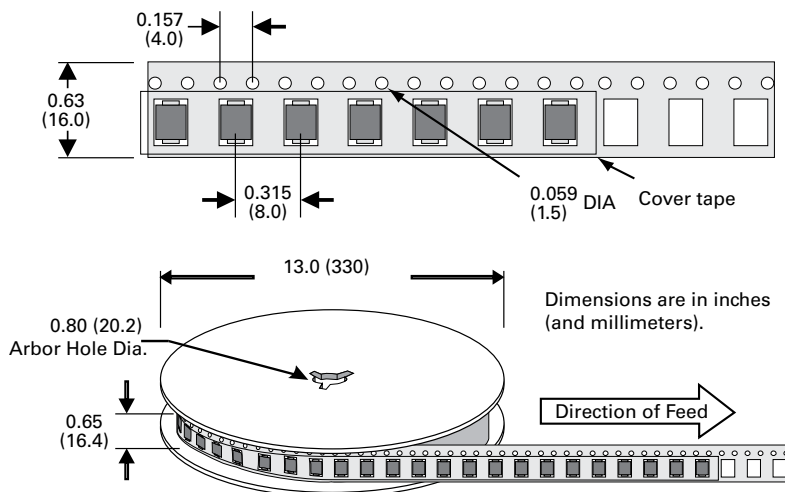

Disclaimer Notice - Information furnished is believed to be accurate and reliable. However, users should independently evaluate the suitability of and test each product selected for their own applications. Littelfuse products are not designed for, and may not be used in, all applications. Read complete Disclaimer Notice at <http://www.littelfuse.com/disclaimer-electronics>.