

# SMDLCE-HRA Series

## 3000 W Low Capacitance Surface Mount in DO-214AB



### Agency Approvals

Agency	Agency File Number
	E230531

### Maximum Ratings & Thermal Characteristics ( $T_A = 25\text{ }^\circ\text{C}$ unless otherwise noted)

Parameter	Symbol	Value	Unit
Peak Pulse Power Dissipation by 10/1000 $\mu\text{s}$ Waveform (Fig.1)(Note 1)	$P_{PPM}$	3000	W
Power Dissipation on Infinite Heat Sink at $T_L = 50\text{ }^\circ\text{C}$	$P_D$	6.5	W
Operating Temperature Range	$T_J$	-65 to 150	$^\circ\text{C}$
Storage Temperature Range	$T_{STG}$	-65 to 175	$^\circ\text{C}$

#### Notes:

1. Non-repetitive current pulse, per Fig. 3 and derated above  $T_J$  (initial) =  $25\text{ }^\circ\text{C}$  per Fig. 2.

## Description

SMDLCE-HRA high reliability series is designed specifically to protect sensitive data line electronic equipment from voltage transients induced by lightning and other transient voltage events.

## Features

- Low capacitance  $\leq 50\text{ pF}$ , 3000 W peak pulse power capability at 10/1000  $\mu\text{s}$  waveform, repetition rate (duty cycles):0.01 %
- For surface mounted applications in order to optimize board space
- Low profile package
- Built-in strain relief
- Typical failure mode is short from over-specified voltage or current
- Whisker test is conducted based on JEDEC JESD201A per its table 4a and 4c
- ESD protection of data lines in accordance with IEC 61000-4-2 ESD 30 kV (Air), 30 kV (Contact)
- EFT protection of data lines in accordance with IEC 61000-4-4
- Glass passivated chip junction
- Low incremental surge resistance
- Fast response and excellent clamping capability
- UL recognized compound meeting flammability rating V-0
- Meet MSL level1, per J-STD-020, high temperature soldering guaranteed:260  $^\circ\text{C}/10$  seconds at terminals
- Matte tin lead-free plated
- Halogen free and RoHS compliant
- Pb-free E3 means 2<sup>nd</sup> level interconnect is Pb-free and the terminal finish material is tin(Sn) (IPC/JEDEC J-STD-609A.01)

## Applications

- I/O Interfaces for avionics applications, such as flight control, FADEC, radar, and etc.
- Protection for aircraft fast data line

### Schematic



# SMDLCE-HRA Series

## 3000 W Low Capacitance Surface Mount in DO-214AB

### Electrical Characteristics

Part Number	Marking Code	Stand-Off Voltage $V_R$ (V)	Minimum Breakdown Voltage $V_{BR}(V)$ @ $I_T$		Test Current $I_T$ (mA)	Maximum Reverse Leakage at $I_R$ @ $V_R$ ( $\mu A$ )	Maximum Clamping Voltage @ $I_{PP} V_C$ (V)	Maximum Peak Pulse Current per (Fig.3) $I_{PP}$ (A)	Maximum Junction Capacitance at 0 Volts $f = 1$ MHz (pF)	Working Inverse Blocking Voltage $V_{WIB}$ (V)	Inverse Blocking Leakage Current at $I_{IB}$ @ $V_{WIB}$ (mA)	Peak Inverse Blocking Voltage $V_{PIB}$ (V)	Agency Approval 
			Min	Max									
SMDLCE12-HRA	SPEEH	12.0	13.30	14.70	1	5	20.9	75.4	50	75	1.0	100	X
SMDLCE13-HRA	SPEGH	13.0	14.40	15.90	1	3	22.5	139.5	50	75	1.0	100	X
SMDLCE14-HRA	SPEKH	14.0	15.60	17.20	1	3	24.2	129.3	50	75	1.0	100	X
SMDLCE15-HRA	SPEMH	15.0	16.70	18.50	1	1	25.4	123.0	50	75	1.0	100	X
SMDLCE16-HRA	SPEPH	16.0	17.80	19.70	1	1	27.0	115.4	50	75	1.0	100	X
SMDLCE17-HRA	SPERH	17.0	18.90	20.90	1	1	28.6	108.7	50	75	1.0	100	X
SMDLCE18-HRA	SPETH	18.0	20.00	22.10	1	1	30.2	102.7	50	75	1.0	100	X
SMDLCE20-HRA	SPEVH	20.0	22.20	24.50	1	1	33.4	92.6	50	75	1.0	100	X
SMDLCE22-HRA	SPEXH	22.0	24.40	26.90	1	1	36.5	84.5	50	75	1.0	100	X
SMDLCE24-HRA	SPEZH	24.0	26.70	29.50	1	1	39.9	77.1	50	75	1.0	100	X
SMDLCE26-HRA	SPFEH	26.0	28.90	31.90	1	1	43.1	71.3	50	75	1.0	100	X
SMDLCE28-HRA	SPFGH	28.0	31.10	34.40	1	1	46.5	66.1	50	75	1.0	100	X
SMDLCE30-HRA	SPFKH	30.0	33.30	36.80	1	1	49.4	62.0	50	75	1.0	100	X
SMDLCE33-HRA	SPFMH	33.0	36.70	40.60	1	1	53.3	56.3	50	75	1.0	100	X
SMDLCE36-HRA	SPFPH	36.0	40.00	44.20	1	1	58.1	51.6	50	75	1.0	100	X
SMDLCE40-HRA	SPFRH	40.0	44.40	49.10	1	1	64.5	46.5	50	75	1.0	100	X
SMDLCE43-HRA	SPFTH	43.0	47.80	52.80	1	1	69.4	43.2	50	75	1.0	100	X
SMDLCE45-HRA	SPFVH	45.0	50.00	55.30	1	1	72.7	41.3	50	75	1.0	100	X
SMDLCE48-HRA	SPFXH	48.0	53.30	58.90	1	1	77.4	38.8	50	75	1.0	100	X
SMDLCE51-HRA	SPFZH	51.0	56.70	62.70	1	1	82.4	36.4	50	75	1.0	100	X
SMDLCE54-HRA	SPGEH	54.0	60.00	66.30	1	1	87.1	34.4	50	100	1.0	125	X
SMDLCE58-HRA	SPGGH	58.0	64.40	71.20	1	1	93.6	32.1	50	100	1.0	125	X
SMDLCE60-HRA	SPGKH	60.0	66.70	73.70	1	1	96.8	31.0	50	100	1.0	125	X
SMDLCE64-HRA	SPGMH	64.0	71.10	78.60	1	1	103.0	29.1	50	100	1.0	125	X
SMDLCE70-HRA	SPGPH	70.0	77.80	86.00	1	1	113.0	26.5	50	125	1.0	150	X

### Screen Process

100 % vision inspection	MIL-STD-750 method 2074
100 % X-RAY inspection	MIL-STD-750 method 2076
100 % temperature cycle test (-55 °C to 150 °C, 20 cycles, dwell time 15 min)	MIL-STD-750 method 1051
100 % reflow (2x)	JEDEC J-STD-020
100 % surge test (2x)	MIL-STD-750 method 4066
100 % HTRB 150 °C bias = $V_R$ (80 % breakdown voltage, 96 hrs)	MIL-STD-750 method 1038
Final electrical test (100 % 3 sigma limit, 100 % dynamic test and PAT limit)	MIL-STD-750 method 4016.4021.4011

Note: Up-screen program can be specified by customer's request by contacting Littelfuse customer service

# SMDLCE-HRA Series

## 3000 W Low Capacitance Surface Mount in DO-214AB

Ratings and Characteristic Curves ( $T_A = 25\text{ }^\circ\text{C}$  unless otherwise noted)

Figure 1 - Peak Pulse Power Rating Curve

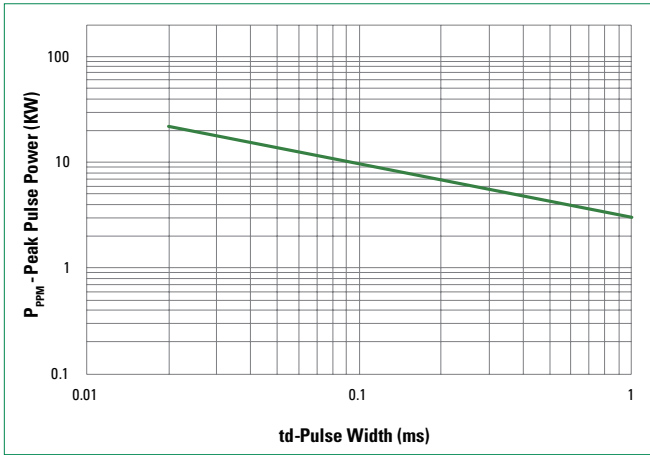

Figure 2 - Peak Pulse Power Derating Curve

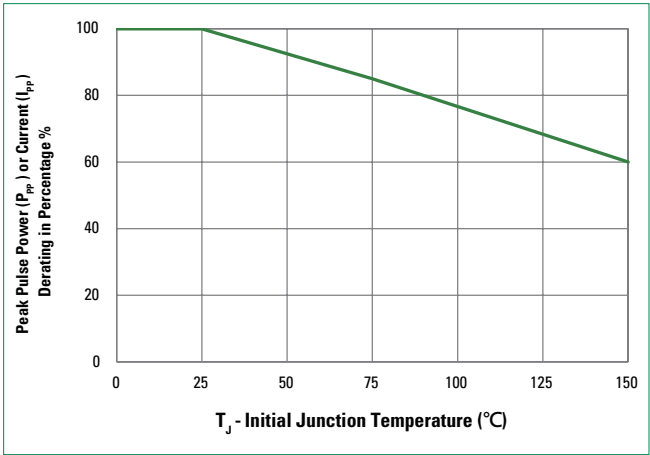

Figure 3 - Pulse Waveform

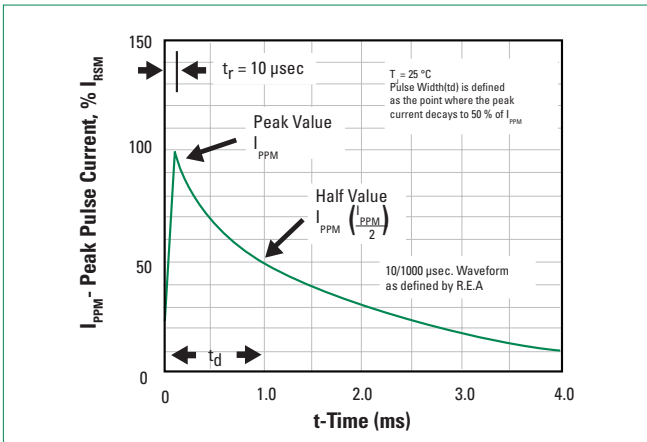
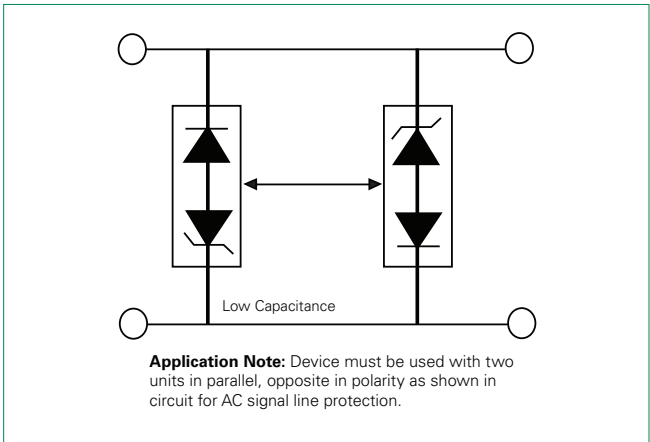

Figure 4 - AC Line Protection Application



# SMDLCE-HRA Series

## 3000 W Low Capacitance Surface Mount in DO-214AB

### Soldering Parameters

<b>Reflow Condition</b>		Lead-free assembly
<b>Pre Heat</b>	- Temperature Min ( $T_{s(min)}$ )	150 °C
	- Temperature Max ( $T_{s(max)}$ )	200 °C
	- Time (min to max) ( $t_s$ )	60 – 180 seconds
<b>Average Ramp Up Rate (Liquidus Temp (<math>T_L</math>) to Peak</b>		3 °C/second max
<b><math>T_{s(max)}</math> to <math>T_L</math> - Ramp-up Rate</b>		3 °C/second max
<b>Reflow</b>	- Temperature ( $T_L$ ) (Liquidus)	217 °C
	- Time (min to max) ( $t_s$ )	60 – 150 seconds
<b>Peak Temperature (<math>T_p</math>)</b>		260 <sup>+0/-5</sup> °C
<b>Time Within 5 °C of Actual Peak Temperature (<math>t_p</math>)</b>		20 – 40 seconds
<b>Ramp-down Rate</b>		6 °C/second max
<b>Time 25 °C to Peak Temperature (<math>T_p</math>)</b>		8 minutes max
<b>Do Not Exceed</b>		260 °C

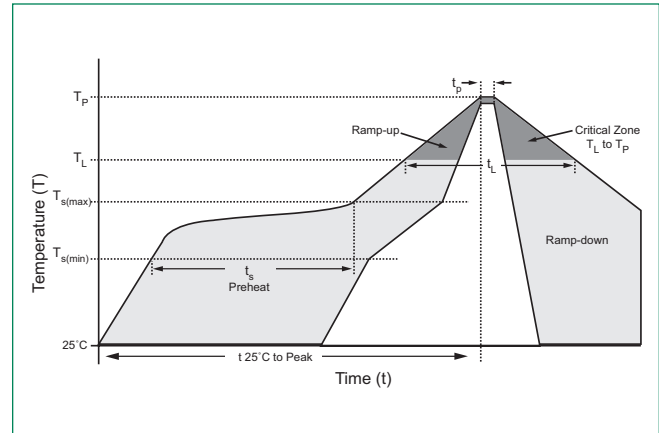

### Physical Specifications

<b>Weight</b>	0.003oz., 0.093g
<b>Case</b>	JEDEC DO-214AB molded plastic body over glass passivated junction.
<b>Polarity</b>	Color band denotes cathode except bidirectional
<b>Terminal</b>	Matte Tin-plated leads. Solderable per JESD22-B102

### Environmental Specifications

<b>High Temperature Storage</b>	JESD22-A103
<b>HTRB</b>	JESD22-A108
<b>Temperature Cycling</b>	JESD22-A104
<b>MSL</b>	JEDEC-J-STD-020, Level 1
<b>H3TRB</b>	JESD22-A101
<b>RSH</b>	JESD22-A111

### Dimensions



Recommended Soldering Pad Layout

Dimensions	Inches		Millimeters	
	Min	Max	Min	Max
A	0.114	0.126	2.900	3.200
B	0.260	0.280	6.600	7.110
C	0.220	0.245	5.590	6.220
D	0.079	0.103	2.060	2.620
E	0.030	0.060	0.760	1.520
F	-	0.008	-	0.203
G	0.305	0.320	7.750	8.130
H	0.006	0.012	0.152	0.305
I	0.129	-	3.300	-
J	0.094	-	2.400	-
K	-	0.165	-	4.200
L	0.094	-	2.400	-

# SMDLCE-HRA Series

3000 W Low Capacitance Surface Mount in DO-214AB

### Part Numbering System

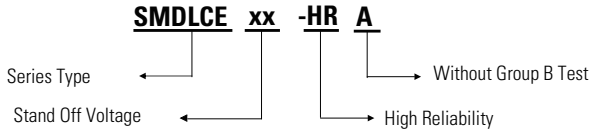

### Part Marking System

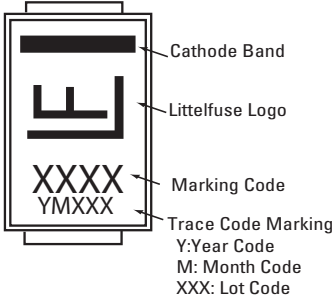

### Packaging

Part number	Component Package	Quantity	Packaging Option	Packaging Specification
SMDLCE-HRA	DO-214AB	500	Tape & Reel - 16 mm tape/7" reel	EIA STD RS-481

### Tape and Reel Specification

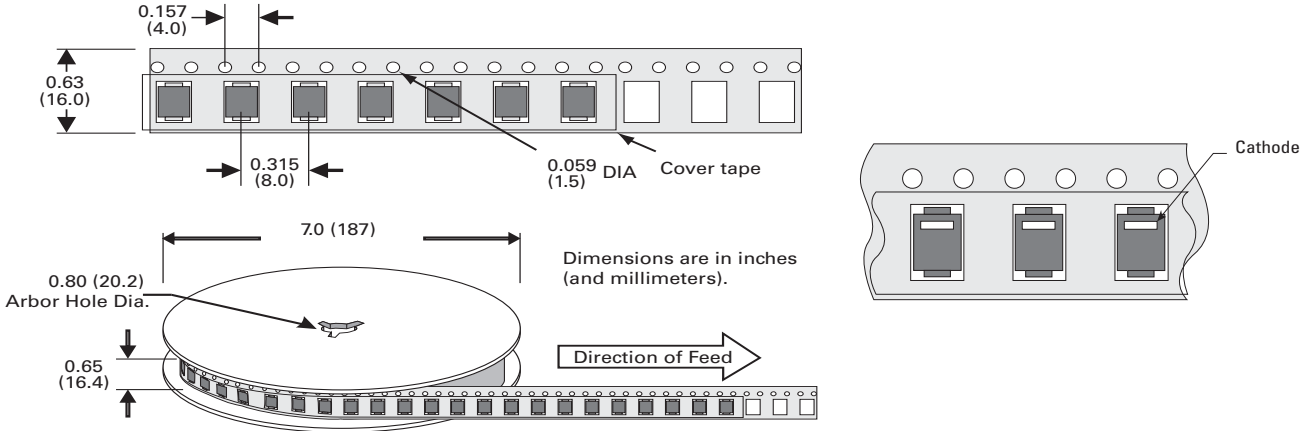

**SMDLCE-HRA Series**

3000 W Low Capacitance Surface Mount in DO-214AB

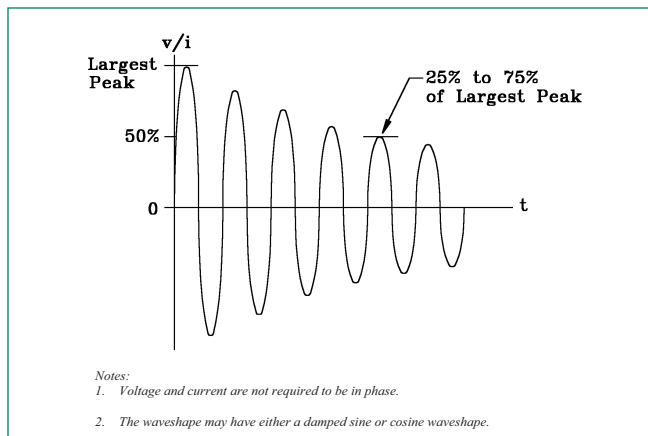
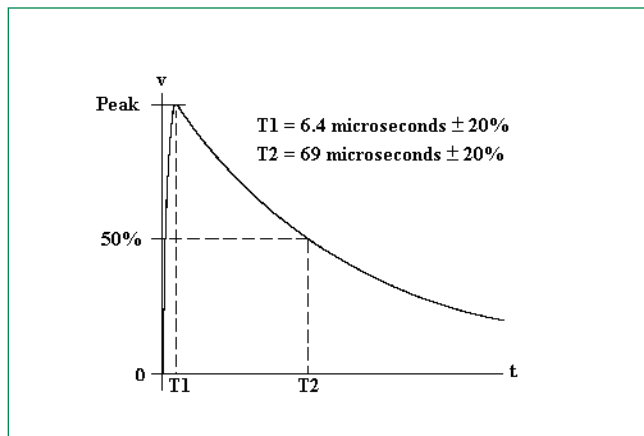
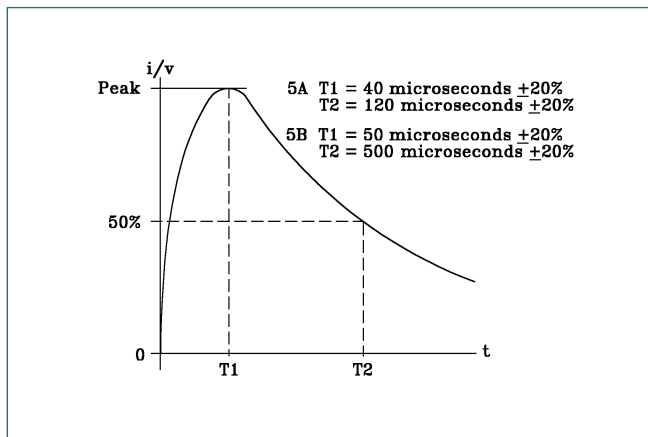
**RTCA/DO-160G Wave 3****RTCA/DO-160G Wave 4****RTCA/DO-160G Wave 5**

# SMDLCE-HRA Series

## 3000 W Low Capacitance Surface Mount in DO-214AB

### Pin Injection Protection Per RTCA/DO-160G

Part Number	25 °C						70 °C						120 °C					
	Wave 3	Wave 4 (6.4/69 μs)			Wave 5a (40/120 μs)		Wave 3	Wave 4 (6.4/69 μs)			Wave 5a (40/120 μs)		Wave 3	Wave 4 (6.4/69 μs)			Wave 5a (40/120 μs)	
	L5	L3	L4	L5	L3	L4	L5	L3	L4	L5	L3	L4	L5	L3	L4	L5	L3	L4
	128A	60A	150A	320A	300A	750A	128A	60A	150A	320A	300A	750A	128A	60A	150A	320A	300A	750A
SMDLCE12-HRA	pass	pass	pass	pass	pass	-	pass	pass	pass	pass	pass	-	pass	pass	pass	pass	-	-
SMDLCE13-HRA	pass	pass	pass	pass	pass	-	pass	pass	pass	pass	pass	-	pass	pass	pass	pass	-	-
SMDLCE14-HRA	pass	pass	pass	pass	pass	-	pass	pass	pass	pass	pass	-	pass	pass	pass	pass	-	-
SMDLCE15-HRA	pass	pass	pass	pass	pass	-	pass	pass	pass	pass	pass	-	pass	pass	pass	pass	-	-
SMDLCE16-HRA	pass	pass	pass	pass	pass	-	pass	pass	pass	pass	-	-	pass	pass	pass	-	-	-
SMDLCE17-HRA	pass	pass	pass	pass	pass	-	pass	pass	pass	pass	-	-	pass	pass	pass	-	-	-
SMDLCE18-HRA	pass	pass	pass	pass	pass	-	pass	pass	pass	pass	-	-	pass	pass	pass	-	-	-
SMDLCE20-HRA	pass	pass	pass	pass	pass	-	pass	pass	pass	pass	-	-	pass	pass	pass	-	-	-
SMDLCE22-HRA	pass	pass	pass	-	-	-	pass	pass	pass	-	-	-	pass	pass	pass	-	-	-
SMDLCE24-HRA	pass	pass	pass	-	-	-	pass	pass	pass	-	-	-	pass	pass	pass	-	-	-
SMDLCE26-HRA	pass	pass	pass	-	-	-	pass	pass	pass	-	-	-	pass	pass	pass	-	-	-
SMDLCE28-HRA	pass	pass	pass	-	-	-	pass	pass	pass	-	-	-	pass	pass	pass	-	-	-
SMDLCE30-HRA	pass	pass	pass	-	-	-	pass	pass	pass	-	-	-	pass	pass	pass	-	-	-
SMDLCE33-HRA	pass	pass	pass	-	-	-	pass	pass	pass	-	-	-	pass	pass	pass	-	-	-
SMDLCE36-HRA	pass	pass	pass	-	-	-	pass	pass	pass	-	-	-	pass	pass	pass	-	-	-
SMDLCE40-HRA	pass	pass	pass	-	-	-	pass	pass	pass	-	-	-	pass	pass	pass	-	-	-
SMDLCE43-HRA	pass	pass	pass	-	-	-	pass	pass	pass	-	-	-	pass	pass	-	-	-	-
SMDLCE45-HRA	pass	pass	pass	-	-	-	pass	pass	-	-	-	-	pass	pass	-	-	-	-
SMDLCE48-HRA	pass	pass	pass	-	-	-	pass	pass	-	-	-	-	pass	pass	-	-	-	-
SMDLCE51-HRA	pass	pass	pass	-	-	-	pass	pass	-	-	-	-	pass	pass	-	-	-	-
SMDLCE54-HRA	pass	pass	pass	-	-	-	pass	pass	-	-	-	-	pass	pass	-	-	-	-
SMDLCE58-HRA	pass	pass	-	-	-	-	pass	pass	-	-	-	-	pass	pass	-	-	-	-
SMDLCE60-HRA	pass	pass	-	-	-	-	pass	pass	-	-	-	-	pass	pass	-	-	-	-
SMDLCE64-HRA	pass	pass	-	-	-	-	pass	pass	-	-	-	-	pass	-	-	-	-	-
SMDLCE70-HRA	pass	pass	-	-	-	-	pass	pass	-	-	-	-	pass	-	-	-	-	-

**Note:**

1. L1 = Level 1, L2 = Level 2, L3 = Level 3, L4 = Level 4, L5 = Level 5