

LTKAK2-L Series

Modified SMT0-218 - 2 kA



Maximum Ratings & Thermal Characteristics

($T_A = 25^\circ\text{C}$ unless otherwise noted)

Parameter	Symbol	Value	Unit
Operating Junction and Storage Temperature Range	T_J, T_{STG}	-40 to 125	$^\circ\text{C}$
Current Rating ¹	I_{PP}	2	kA

Notes: 1. Rated min I_{PP} measured with 8/20 μs pulse.

Functional Diagram



Description

The LTKAK2-L series offers a clamping voltage lower than alternative technologies such as MOVs and GDTs. Rated to 2KA (8/20us) surge current, LTKAK2-L series offers a high level of protection for mission critical and high reliability applications. It aids compliance to surge requirements such as IEC 61000-4-5 (Level 4).

The compact surface mount SMT0218 package is compatible with automated PCBA processes and enables high power density designs

Features & Benefits

- High Power TVS in a compact, surface mount, package
- Patent pending package design
- Ideal for automated PCB assembly process, reducing manufacturing costs and improving soldering quality, as compared to axial leaded packages
- Bi-directional devices
- Low clamping resistance enabling a low clamping voltage
- Meet MSL level 1, per J-STD-020, LF maximum peak of 245°C
- Halogen free and RoHS compliant
- Pb-free E3 means 2nd level interconnect is Pb-free and the terminal finish material is tin (Sn) (IPC/JEDEC J-STD-609A.01)
- UL Recognized epoxy meeting flammability rating V-0

Electrical Characteristics ($T_A = 25^\circ\text{C}$ unless otherwise noted)

Part Number (Uni)	Standoff Voltage (VSO) (V)	Max. Reverse Leakage (I_R) @ V_{SO} μA	Reverse Breakdown Voltage (V_{BR}) @ I_T		Test Current I_T (mA)	Max. Clamping Voltage V_{CL} @ I_{PP} Peak Pulse Current (I_{PP}) (Note 1)		Max. Temp Coefficient of V_{BR} (%/ $^\circ\text{C}$)	Max. Capacitance 0 Bias 10 kHz (nF)
			Min Volts	Max Volts		V_{CL} Volts	I_{PP} Amps		
LTKAK2-150C-L	150	10	167.0	185.0	5	243	2,000	0.1	7.0
LTKAK2-160C-L	160	10	178.0	197.0	5	259	2,000	0.1	6.5
LTKAK2-170C-L	170	10	189.9	208.9	5	275	2,000	0.1	6.5

Note: Using 8/20 μs wave shape as defined in IEC 61000-4-5.

LTKAK2-L Series

Modified SMT0-218 - 2 kA

I-V Curve Characteristics

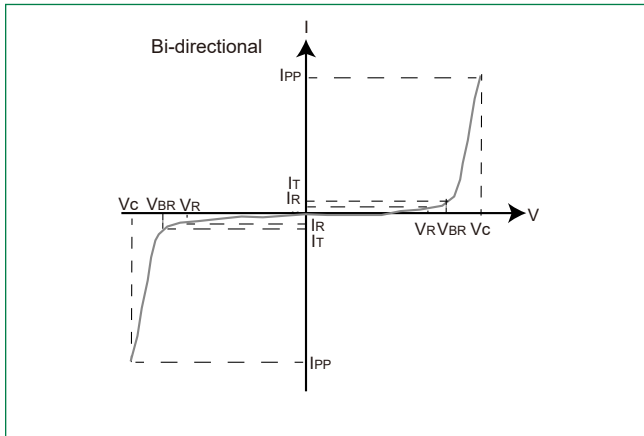

- P_{PPM} Peak Pulse Power Dissipation** -- Max power dissipation
 V_R Stand-off Voltage -- Maximum voltage that can be applied to the TVS without operation
 V_{BR} Breakdown Voltage -- Maximum voltage that flows though the TVS at a specified test current (I_T)
 V_C Clamping Voltage -- Peak voltage measured across the TVS at a specified I_{ppm} (peak impulse current)
 I_R Reverse Leakage Current -- Current measured at V_R
 V_F Forward Voltage Drop for Uni-directional

Ratings and Characteristic Curves ($T_A = 25^\circ\text{C}$ unless otherwise noted)

Peak Power Derating

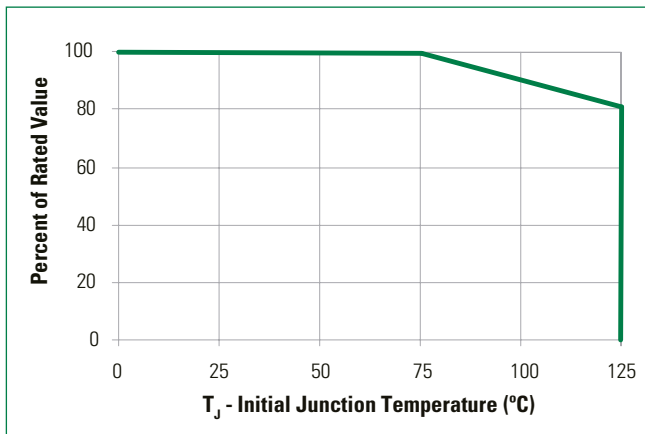

Typical Peak Pulse Power Rating Curve

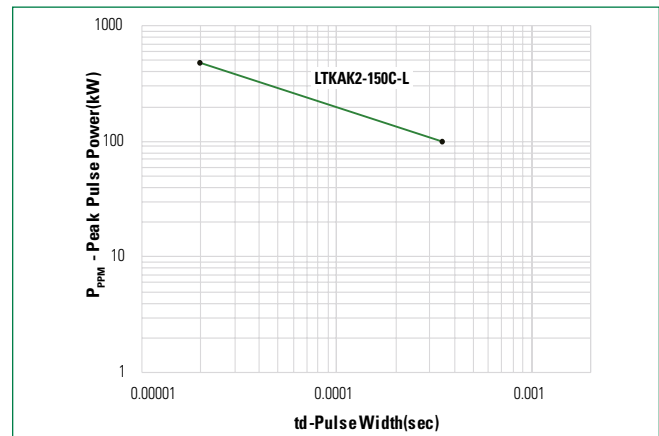

LTKAK2-L Series

Modified SMT0-218 - 2 kA

Soldering Parameters

Reflow Condition		Lead-free assembly
Pre Heat	- Temperature Min ($T_{s(\min)}$)	150 °C
	- Temperature Max ($T_{s(\max)}$)	200 °C
	- Time (min to max) (t_s)	60 – 120 secs
Average ramp up rate (Liquidus Temp (T_L) to peak)		3 °C/second max
$T_{s(\max)}$ to T_A - Ramp-up Rate		3 °C/second max
Reflow	- Temperature (T_L) (Liquidus)	217 °C
	- Time (min to max) (T_s)	60 – 150 seconds
Peak Temperature (T_p)		245 ^{+0/-5} °C
Time within 5 °C of actual peak Temperature (t_p)		30 seconds
Ramp-down Rate		6 °C/second max
Time 25 °C to peak Temperature (T_p)		8 minutes Max.
Do not exceed		245 °C

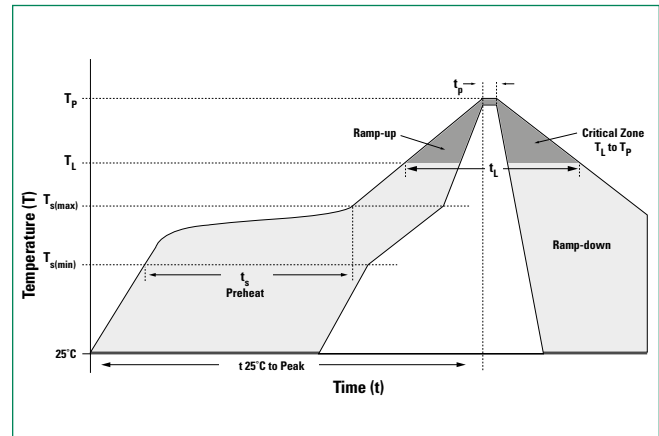

Physical Specifications

Weight	Contact manufacturer
Case	Epoxy encapsulated
Terminal	Tin plated lead, solderable per MIL-STD-202 Method 208

Environmental Specifications

High Temp. Storage	JESD22-A103
HTRB	JESD22-A108
MSL	J-STD-020, Level 1
H3TRB	JESD22-A101
RSH	JESD22-B106

Part Marking System

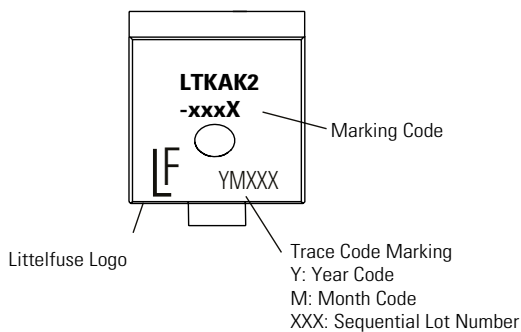

Part Marking System

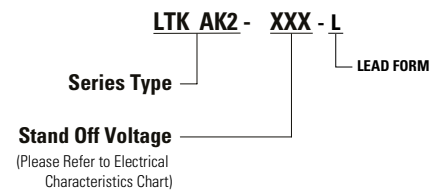

LTKAK2-L Series

Modified SMT0-218 - 2 kA

Dimensions

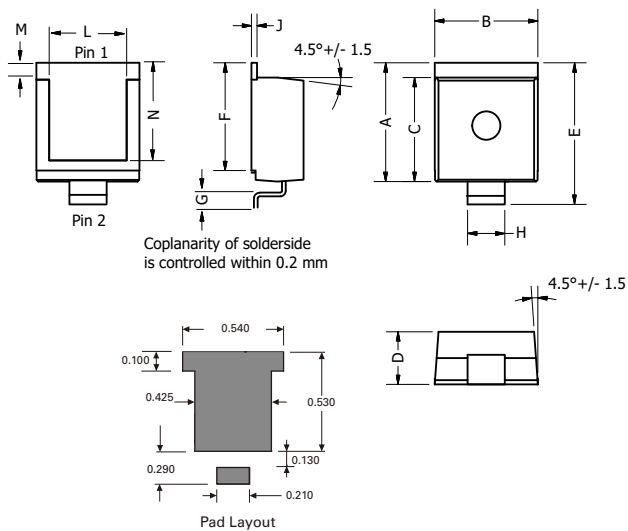

Dimensions	Inches		Millimeters	
	Min	Max	Min	Max
A	0.621	0.655	15.78	16.63
B	0.529	0.594	13.43	15.09
C	0.544	0.561	13.83	14.24
D	0.273	0.285	6.94	7.24
E	0.768	0.843	19.52	21.42
F	0.567	0.587	14.40	14.90
G	0.087	0.126	2.20	3.20
H	0.193	0.222	4.89	5.65
J	0.028	0.033	0.72	0.85
L	0.400	0.440	10.17	11.17
M	0.073	0.112	1.85	2.85
N	0.510	0.533	12.95	13.55

Packaging

Part number	Weight	Packing Mode	Base Quantity
LTKAK2-xxxC-L	4.34g	Tube pack	100 (25/Tube)

Disclaimer Notice - Information furnished is believed to be accurate and reliable. However, users should independently evaluate the suitability of and test each product selected for their own applications. Littelfuse products are not designed for, and may not be used in, all applications. Read complete Disclaimer Notice at <http://www.littelfuse.com/disclaimer-electronics>.