

TRDU SERIES

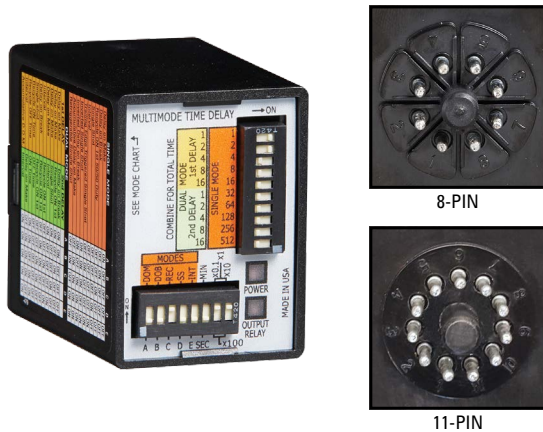

Description

The TRDU Series is a versatile universal time delay relay with 21 selectable single and dual functions. The dual functions replace up to three timers required to accomplish the same function. Both the function and the timing range are selectable with switches located on the face of the unit. Two LED's indicate input voltage and output status. This device offers full 10A isolated relay output contacts in either SPDT or DPDT. The TRDU replaces hundreds of part numbers, thereby, reducing your stock inventory requirements.

21 Functions

Five switches are provided to set one of 10 single or 11 dual modes of operation.

Features & Benefits

FEATURES	BENEFITS
Multifunction: 21 timing functions	Replace hundreds of parts and reduce stocking requirements
Microcontroller based	Repeat Accuracy + / - 0.1%
User selectable time delay	Timing settings are switch selectable 0.1s - 1,705h in eight ranges for added flexibility
Isolated 10A, SPDT or DPDT output contacts	Allows control of loads for AC or DC voltages
LED indicators	Provides visual indication of input voltage and relay status

Wiring Diagram

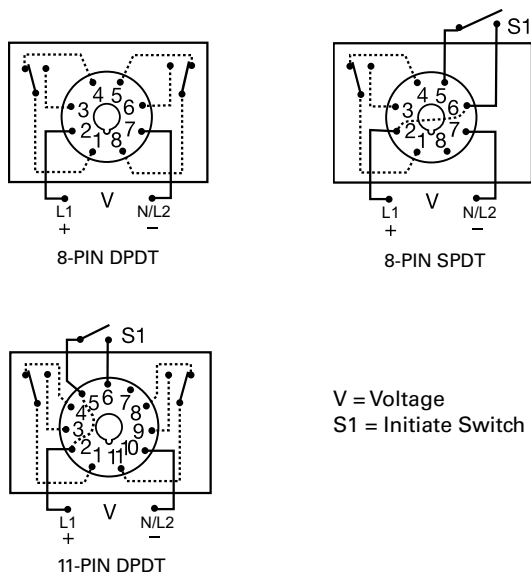

Ordering Information

MODEL	INPUT VOLTAGE	BASE CONNECTION
TRDU120A1	120VAC	8-pin, DPDT*
TRDU120A2	120VAC	8-pin, SPDT
TRDU120A3	120VAC	11-pin, DPDT
TRDU12D1	12VDC	8-pin, DPDT*
TRDU12D2	12VDC	8-pin, SPDT
TRDU230A2	230VAC	8-pin, SPDT
TRDU24A1	24VAC/DC	8-pin, DPDT*
TRDU24A2	24VAC/DC	8-pin, SPDT
TRDU24A3	24VAC/DC	11-pin, DPDT

If you don't find the part you need, call us for a custom product 800-843-8848

*Limited to 9 operating functions in 8-pin DPDT units.

Accessories



BZ1 Front Panel Mount Kit

Provides an easy method of through-the-panel mounting of 8- or 11-pin plug-in timers, flashers, and other controls.



NDS-8 Octal 8-pin Socket

8-pin 35mm DIN rail or surface mount. Surface mounted with two #6 screws or snaps onto a 35 mm DIN rail. Uses PSC8 hold-down clips.



NDS-11 11-pin Socket

11-pin 35mm DIN rail or surface mount. Surface mounted with two #6 screws or snaps onto a 35 mm DIN rail. Uses PSC11 hold-down clips.



PSC8 or PSC11 Hold-down Clips

Securely mounts plug-in controls in any position. Provides protection against vibration. Use PSC8 with NDS-8 Octal Socket or PSC11 with NDS-11 Socket. Sold in sets of two.



C103PM (AL) DIN Rail

35 mm aluminum DIN rail available in a 36 in. (91.4 cm) length.

TRDU SERIES

Specifications

Time Delay

Type Microcontroller
Range: Switch Selectable** Single Functions: 0.1s - 1,705h in 8 ranges
 Dual Functions: 0.1s - 3,100m each in 8 ranges
Adjustments Multiplier: 3 position DIP switches select 0.1, 1, 10, or 100 in s or m

Setting Accuracy ±1% or 50ms, whichever is greater
Repeat Accuracy ±0.1% or 20ms, whichever is greater
Timing Functions Five switches are provided to set one of twenty-one single or dual functions

Reset Time ≤ 50ms
Initiate Time 120VAC: 75ms

Time Delay vs Temp. & Voltage ±1%

Indication **Two LEDs indicate Input** **1) Input voltage applied 2) Output relay status**

Voltage 12VDC, 24VAC/DC, 120VAC, or 230VAC

Tolerance -15% - 20%
 -20% - 10%

120 & 230VAC 50/60Hz

AC Line Frequency 50/60Hz

Power Consumption 24 to 230V ≤ 3W; 12VDC ≤ 2W

Output Electromechanical relay
 Type SPDT or DPDT
 Rating 10A resistive @ 120/240VAC & 28 VDC;
 1/3 hp @ 120/240VAC

Life Mechanical - 1 x 10⁷; Electrical - 1 x 10⁶

Protection

Isolation Voltage ≥ 1500V RMS input to output

Insulation Resistance ≥ 100 MΩ

Polarity DC units are reverse polarity protected

Mechanical

Mounting

Plug-in socket

Dimensions

H 76.7 mm (3.1"); **W** 60.7 mm (2.39");

D 45.2 mm (1.78")

Termination

Environmental

Operating/Storage

Temperature

-20° to 65°C / -40° to 85°C

Weight

≈ 5.8 oz (164 g)

**For CE approved applications, power must be removed from the unit when a switch position is changed.

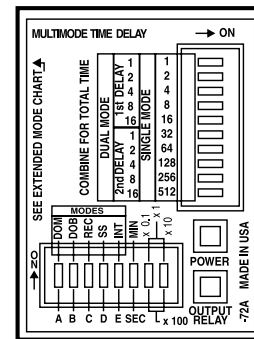

Function Diagrams

Single Functions

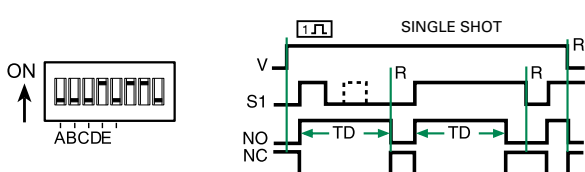
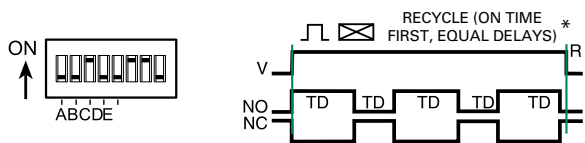
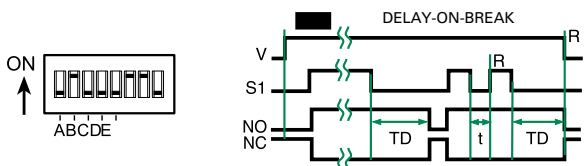
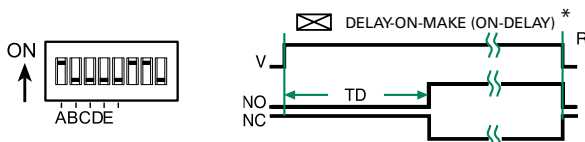

Dual Functions

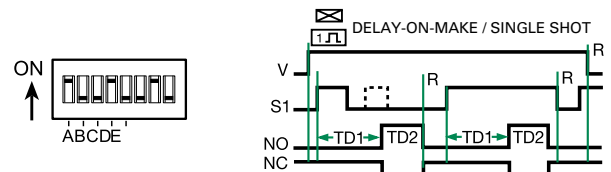
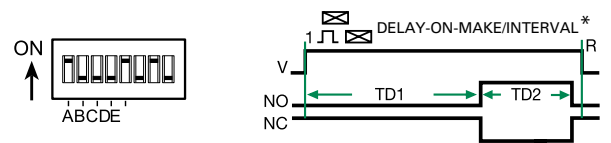
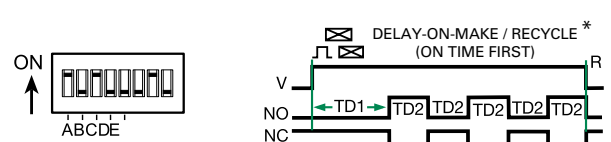
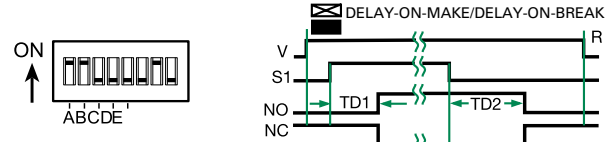

TRDU SERIES

Single Functions

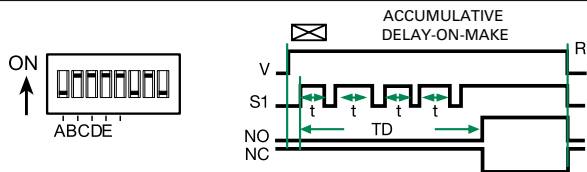
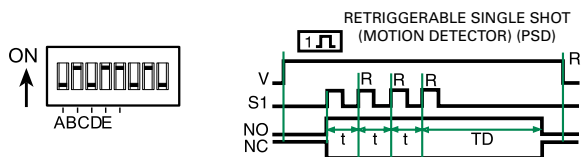
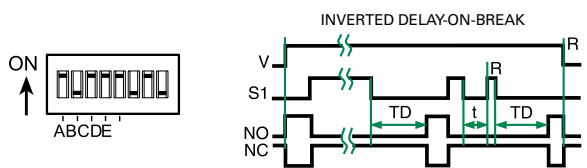
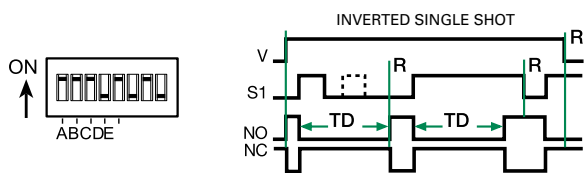
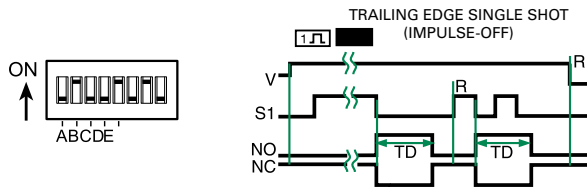
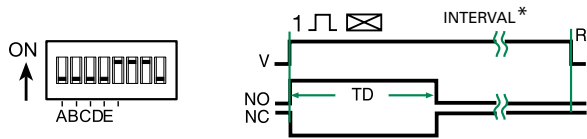

Dual Functions

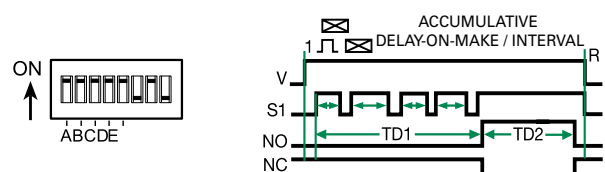
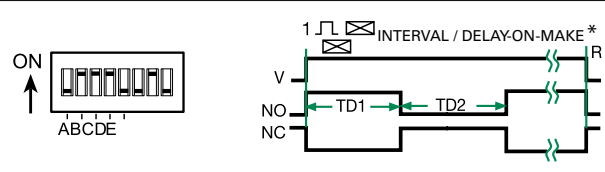
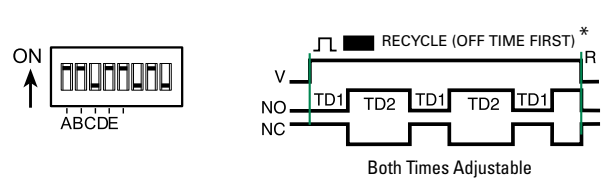
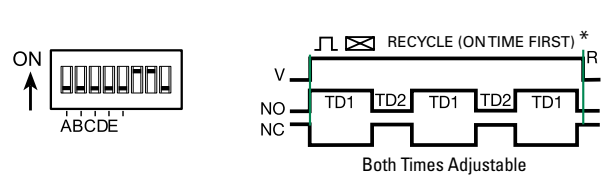
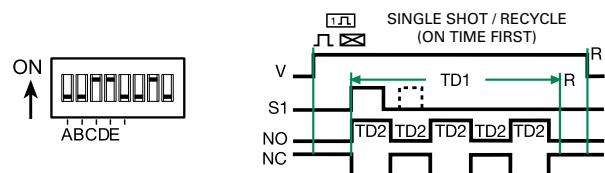
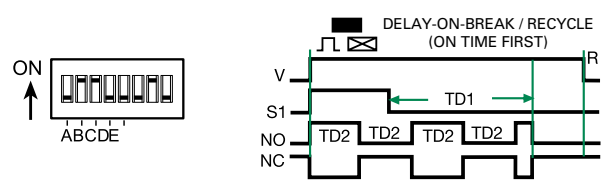
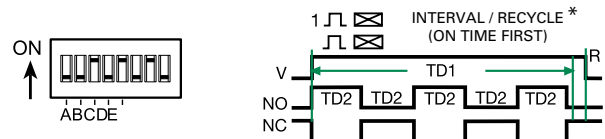

KEY

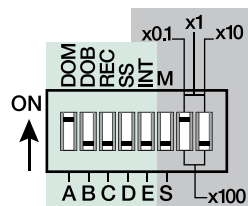

5 Switches for Function Selection

3 Switches for Time Delay Range

LEGEND

V = Voltage
 R = Reset
 S1 = Initiate Switch
 NO = Normally Open Contact
 NC = Normally Closed Contact
 TD, TD1, TD2 = Complete Time Delay
 t = Partial Time Delay
 DOM = Delay-on-Make
 DOB = Delay-on-Break
 REC = Recycle
 SS = Single Shot
 INT = Interval
 M = Minutes
 S = Seconds
 — = Undefined time

* 9 Functions included in the 8 pin DPDT models

NOTE: The time delay range is the same for both functions when dual functions are selected.