

TVS Diode Arrays

TVS Avalanche Diode Array in a Bipolar Chip Scale Package

SP0504BBC, SP0508BBC, SP0516BBC

This family of avalanche diode arrays are designed for ESD protection and offered in an ultra small chip scale package. The multi-channel devices are used to help protect sensitive digital or analog input circuits on data, signal, or control lines with Bipolar voltage levels up to 5VDC. The array is ideal for protection when AC signals are present.

The state-of-the-art structure is designed to suppress ESD and other transient over-voltage events to meet the International Electrotechnical Compaability (EMC transient immunity standarts IEC 61000-4-2 for Electrostatic Discharge Requirements).

The monolithic silicon devices are comprised of specially designed structures for transient voltage suppression (TVS). The size and shape of these structures has been tailored for transient protection. The low capacitance and clamp voltage are ideal for high speed signal line protection.

Ordering Information

NOTE: Bump pitch is 0.65mm

Part Number	Diode Channels	Bumps	CS Package Size (mm)	Quantity Per Reel
SP0504BBCT	4	6	1.804 x 1.154	3500
SP0508BBCT	8	10	3.104 x 1.154	3500
SP0516BBCT	16	20	3.104 x 2.454	3500

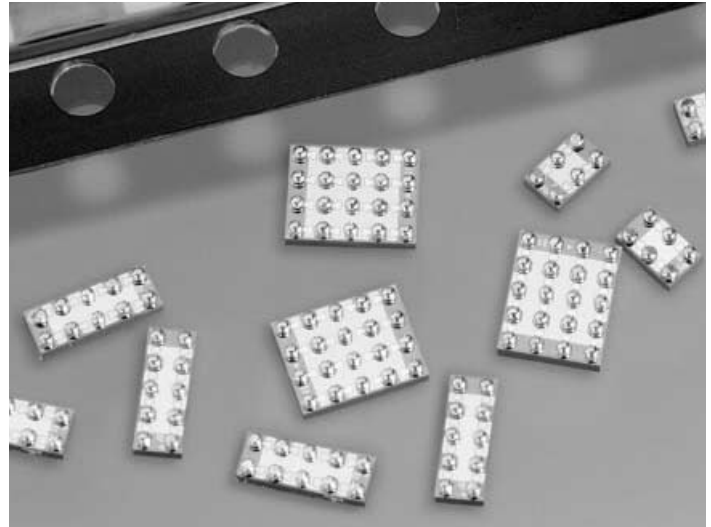

Schematic

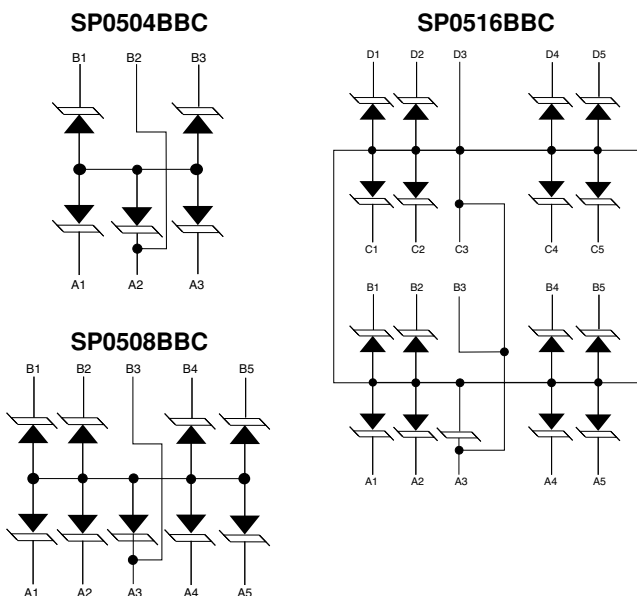

Features

- An Array of 4, 8 and 16 Avalanche Diodes in a ultra small Chip Scale Package (0.65mm bump pitch)
- ESD Capability per HBM Standards
 - IEC 61000-4-2, Direct Discharge18kV (Level 4)
 - IEC 61000-4-2, Air Discharge30kV (Level 4)
 - MIL STD 883D (Method 3015.7)30kV
- Bipolar signal line protection for applications up to 5V
- Fast response time< 1ns
- Low input capacitance39pF Typical
- Low clamp voltage12V Typical
- Low input leakage10uA Max
- Operating temperature range- 40°C to 85°C

Applications

- Cell phone handsets
- Personal Digital Assistants (PDA)
- Portable handheld equipment (Laptop, Palmtop computers)
- Computer port, keyboard (USB1.1)
- Set-Top Box (Audio and Video ports)
- PCMCIA cards
- MP3 players
- Digital still cameras
- Digital video cameras

TVS Diode Arrays

TVS Avalanche Diode Array in a Bipolar Chip Scale Package

SP0504BBC, SP0508BBC, SP0516BBC

Electrical Specifications $T_A = 25^\circ\text{C}$ Unless Otherwise Specified

PARAMETER	TEST CONDITIONS	MIN	TYPICAL	MAX	UNITS
Reverse Standoff Voltage	$I = 10\mu\text{A}$	± 5.9	-	-	V
Reverse Standoff Leakage Current	$V = \text{TBD}$			100	nA
Signal Clamp Voltage					
Positive	$I = 10\text{mA}$	6.0	7.6	9.2	V
Negative	$I = 10\text{mA}$	- 9.2	- 7.6	- 6.0	V
Clamp Voltage during ESD					
MIL-STD-883D Method 3015	8 kV Positive		14		V
	8 kV Negative		-14		V
ESD Test Level					
IEC-61000-4-2, Contact discharge		18			kV
MIL-STD-883D Method 3015 (HBM)		30			kV
Capacitance	2.5VDC @ 1Mhz		39		pF
Turn on/off Time			<1		ns
Temperature Range					
Operating		- 40		85	$^\circ\text{C}$
Storage		- 65		150	$^\circ\text{C}$

SILICON PROTECTION 01
CIRCUITS

Typical Solder Reflow Thermal Profile (No-Clean Flux)

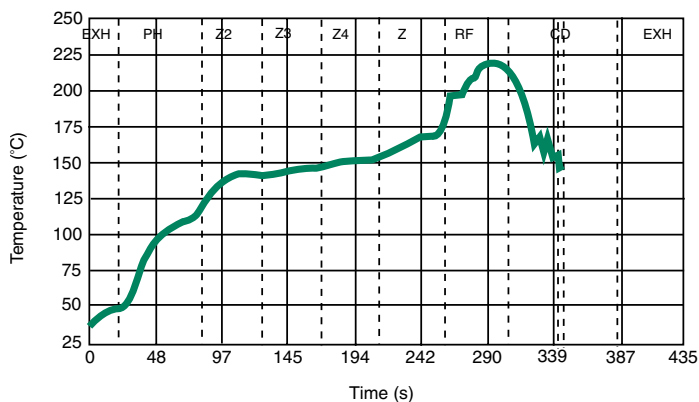

PRINTED CIRCUIT BOARD RECOMMENDATIONS	
PARAMETER	VALUE
Pad Size on PCB	0.300mm
Pad Shape	Round
Pad Definition	Non-Solder Mask defined pads
Solder Mask Opening	0.350mm Round
Solder Stencil Thickness	0.125 - 0.150mm
Solder Stencil Aperture Opening (laser cut, 5% tapered walls)	0.360mm Round
Solder Flux Ratio	50/50 by volume
Solder Paste Type	No Clean
Pad Protective Finish	OSP (Entek Cu Plus 106A)
Tolerance — Edge To Corner Ball	$\pm 50\mu\text{m}$
Solder Ball Side Coplanarity	$\pm 20\mu\text{m}$
Maximum Dwell Time Above Liquidous	60 seconds
Soldering Maximum Temperature	260 $^\circ\text{C}$

TVS Diode Arrays

TVS Avalanche Diode Array in a Bipolar Chip Scale Package

SP0504BBC, SP0508BBC, SP0516BBC

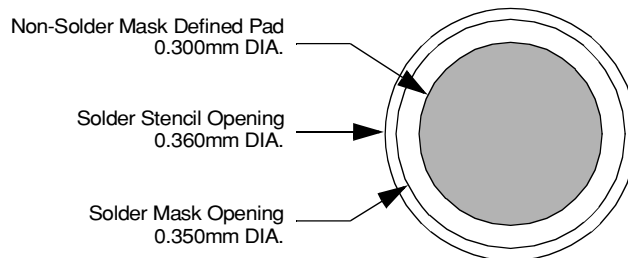
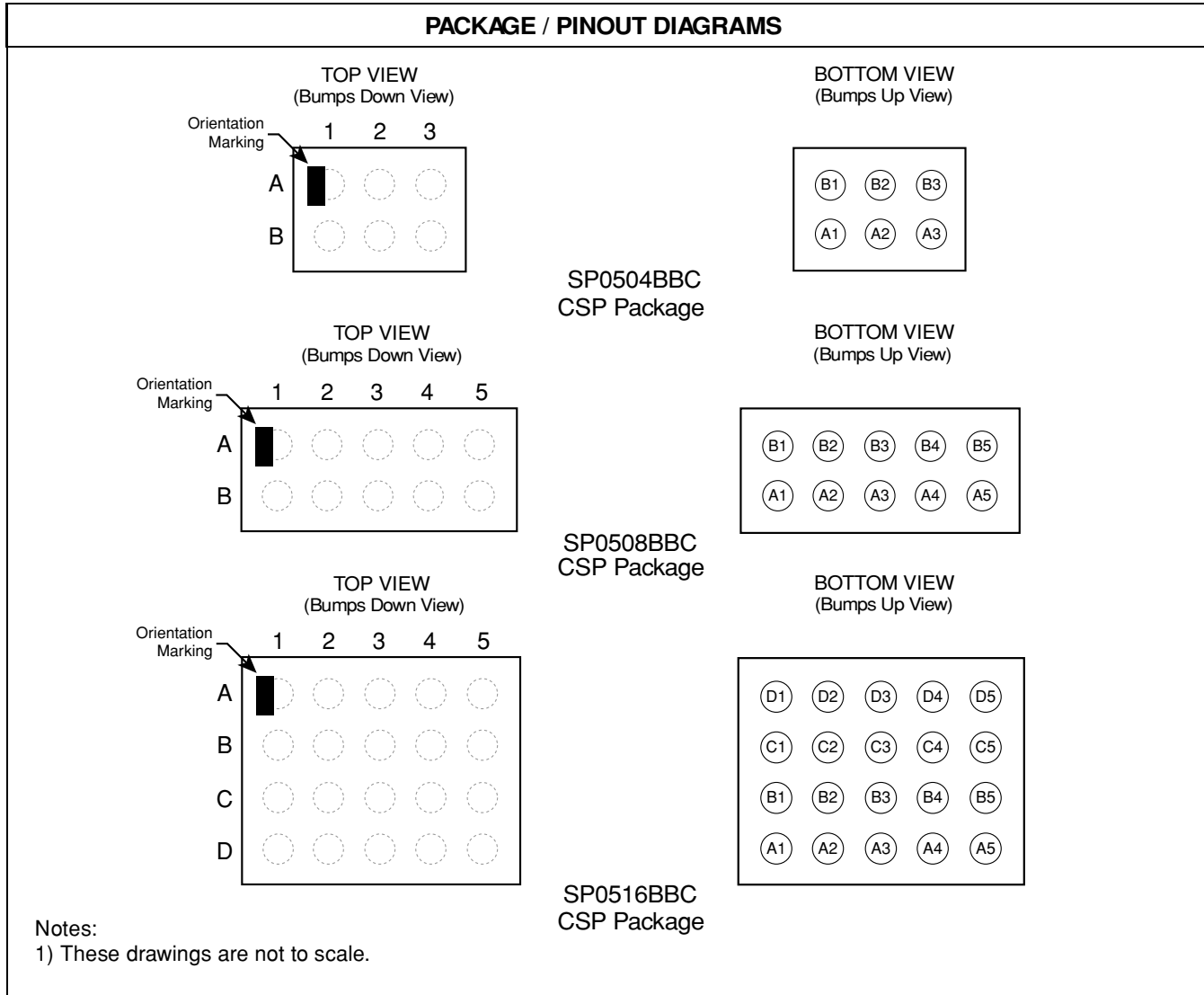

TVS Diode Arrays

TVS Avalanche Diode Array in a Bipolar Chip Scale Package

SP0504BBC, SP0508BBC, SP0516BBC

SP0504BBC 6-bump

CSP Mechanical Specifications

The SP0504BBC devices are packaged in a 6-bump custom Chip Scale Package (CSP). Dimensions are presented below.

PACKAGE DIMENSIONS						
Package	Custom CSP					
Bumps	6					
Dim	Millimeters			Inches		
	Min	Nom	Max	Min	Nom	Max
A1	1.109	1.154	1.199	0.0437	0.0454	0.0472
A2	1.759	1.804	1.849	0.0693	0.0710	0.0728
B1	0.645	0.650	0.655	0.0254	0.0256	0.0258
B2	0.645	0.650	0.655	0.0254	0.0256	0.0258
B3	0.645	0.650	0.655	0.0254	0.0256	0.0258
C1	0.202	0.252	0.302	0.0080	0.0099	0.0119
C2	0.202	0.252	0.302	0.0080	0.0099	0.0119
D1	0.600	0.644	0.687	0.0236	0.0253	0.0271
D2	0.356	0.381	0.406	0.0140	0.0150	0.0160
# per tape and reel	3500 pieces					
Controlling dimension: millimeters						

Mechanical Package Diagrams

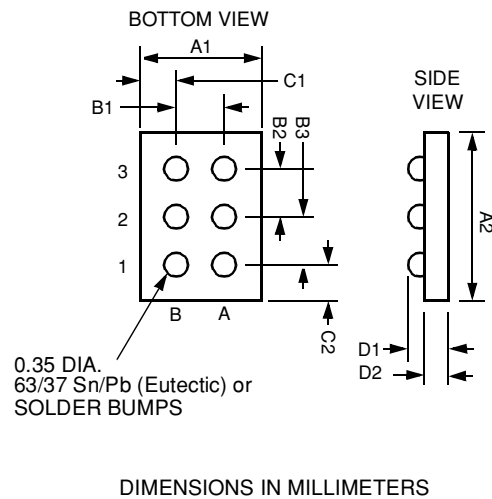

TVS DIODE ARRAYS 5

CSP Tape and Reel Specifications

PART NUMBER	CHIP SIZE (mm)	POCKET SIZE (mm) B ₀ X A ₀ X K ₀	TAPE WIDTH W	REEL DIA.	QTY PER REEL	P ₀	P ₁
SP0504BBC	1.804 X 1.154 X 0.644	1.98 X 1.32 X 0.91	8mm	178mm (7")	3500	4mm	4mm

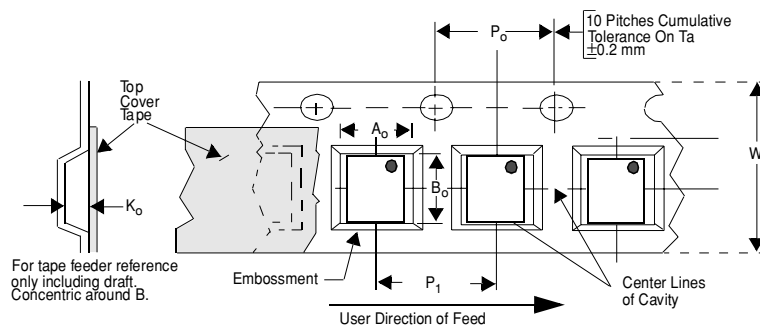

Tape Specifications

TVS Diode Arrays

TVS Avalanche Diode Array in a Bipolar Chip Scale Package

SP0504BBC, SP0508BBC, SP0516BBC

SP0508BBC10- bump

CSP Mechanical Specifications

The SP0508BBC devices are packaged in a 6-bump custom Chip Scale Package (CSP). Dimensions are presented below.

PACKAGE DIMENSIONS						
Package	Custom CSP					
Bumps	10					
Dim	Millimeters			Inches		
	Min	Nom	Max	Min	Nom	Max
A1	1.109	1.154	1.199	0.0437	0.0454	0.0472
A2	3.059	3.104	3.149	0.1204	0.1222	0.1240
B1	0.645	0.650	0.655	0.0254	0.0256	0.0258
B2	0.645	0.650	0.655	0.0254	0.0256	0.0258
C1	0.202	0.252	0.302	0.0080	0.0099	0.0119
C2	0.202	0.252	0.302	0.0080	0.0099	0.0119
D1	0.600	0.644	0.687	0.0236	0.0253	0.0271
D2	0.356	0.381	0.406	0.0140	0.0150	0.0160
# per tape and reel	3500 pieces					
Controlling dimension: millimeters						

Mechanical Package Diagrams

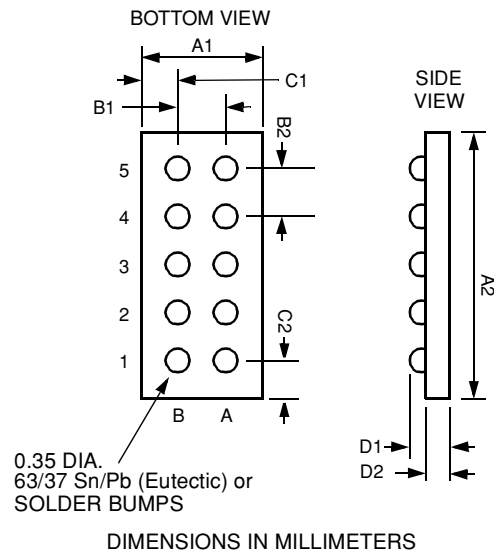

CSP Tape and Reel Specifications

PART NUMBER	CHIP SIZE (mm)	POCKET SIZE (mm) $B_0 \times A_0 \times K_0$	TAPE WIDTH W	REEL DIAMETER	QTY PER REEL	P_0	P_1
SP0508BBC	3.104 X 1.154 X 0.644	3.28 X 1.32 X 0.81	8mm	178mm (7")	3500	4mm	4mm

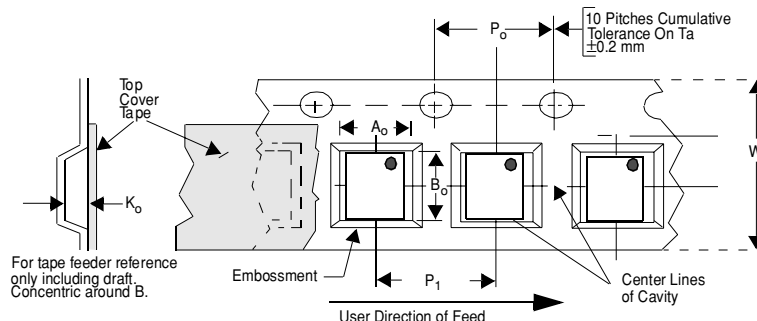

Tape Specifications

TVS Diode Arrays

TVS Avalanche Diode Array in a Bipolar Chip Scale Package

SP0504BBC, SP0508BBC, SP0516BBC

SP0516BBC 20-bump

CSP Mechanical Specifications

The SP0516BBC devices are packaged in a 20-bump custom Chip Scale Package (CSP). Dimensions are presented below.

PACKAGE DIMENSIONS						
Package	Custom CSP					
Bumps	20					
Dim	Millimeters			Inches		
	Min	Nom	Max	Min	Nom	Max
A1	2.409	2.454	2.499	0.0948	0.0966	0.0984
A2	3.059	3.104	3.149	0.1204	0.1222	0.1240
B1	0.645	0.650	0.655	0.0254	0.0256	0.0258
B2	0.645	0.650	0.655	0.0254	0.0256	0.0258
C1	0.202	0.252	0.302	0.0080	0.0099	0.0119
C2	0.202	0.252	0.302	0.0080	0.0099	0.0119
D1	0.600	0.644	0.687	0.0236	0.0253	0.0271
D2	0.356	0.381	0.406	0.0140	0.0150	0.0160
# per tape and reel	3500 pieces					
Controlling dimension: millimeters						

Mechanical Package Diagrams

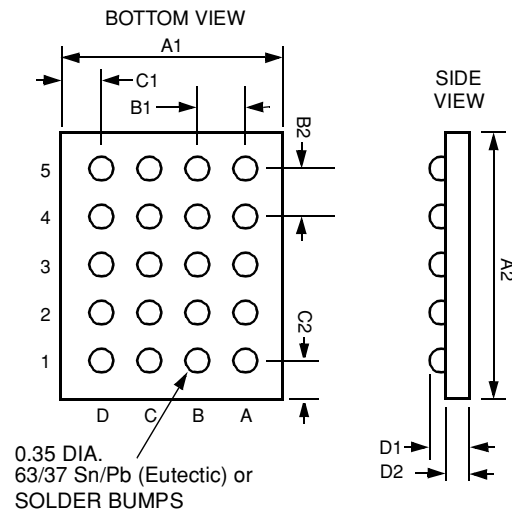

DIMENSIONS IN MILLIMETERS

SILICON PROTECTION CIRCUITS

CSP Tape and Reel Specifications

PART NUMBER	CHIP SIZE (mm)	POCKET SIZE (mm) $B_0 \times A_0 \times K_0$	TAPE WIDTH W	REEL DIAMETER	QTY PER REEL	P_0	P_1
SP0516BBC	3.104 X 2.454 X 0.644	3.28 X 2.64 X 0.86	8mm	178mm (7")	3500	4mm	4mm

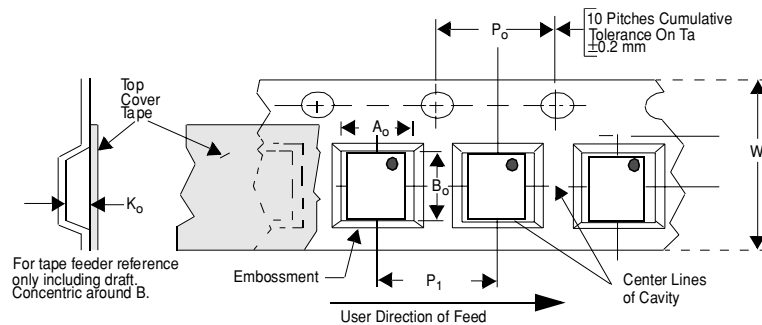

Tape Specifications