

SMBLCE-HRA Series

Surface Mount - 600W

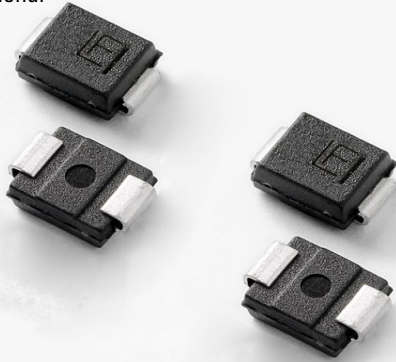

Uni-directional



Agency Approvals

Agency	Agency File/Certificate Number
	E230531

Maximum Ratings & Thermal Characteristics

($T_A=25^\circ\text{C}$ unless otherwise noted)

Parameter	Symbol	Value	Unit
Peak Pulse Power Dissipation ($I_{PP} \times V_C$) at $T_L=25^\circ\text{C}$ by 10/1000 μs Waveform (fig.1)(Note 1)	P_{PPM}	600	W
Power Dissipation on Infinite Heat Sink at $T_L=50^\circ\text{C}$	P_D	3.0	W
Operating Temperature Range	T_J	-65 to 150	$^\circ\text{C}$
Typical Thermal Resistance Junction to Lead	T_{STG}	-65 to 175	$^\circ\text{C}$

Notes:

1. Non-repetitive current pulse, per Fig. 3 and derated above T_J (initial) = 25°C per Fig. 2.

Schematic

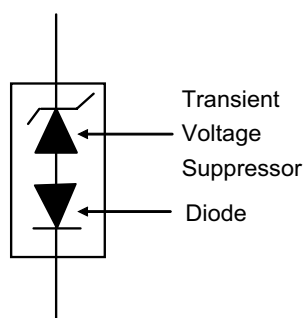

Description

SMBLCE-HRA High Reliability series is designed specifically to protect sensitive electronic equipment from voltage transients induced by lightning and other transient voltage events.

Features

- For surface mounted applications in order to optimize board space
- Low profile package
- Built-in strain relief
- Typical failure mode is short from over-specified voltage or current
- Whisker test is conducted based on JEDEC JESD201A per its table 4a and 4c
- ESD protection of data lines in accordance with IEC 61000-4-2 ESD 30kV (Air), 30kV (Contact)
- EFT protection of data lines in accordance with IEC 61000-4-4
- Glass passivated chip junction
- Low incremental surge resistance
- 600W peak pulse power capability at 10/1000 μs waveform, repetition rate (duty cycles):0.01 %
- Fast response and excellent clamping capability
- UL Recognized compound meeting flammability rating V-0
- Meet MSL level1, per J-STD-020, high temperature soldering guaranteed:260 $^\circ\text{C}$ /10 seconds at terminals
- Matte tin lead-free plated
- Halogen free and RoHS compliant
- Pb-free E3 means 2nd level interconnect is Pb-free and the terminal finish material is tin(Sn) (IPC/JEDEC J-STD-609A.01)

Applications

TVS Components are ideal for the protection of I/O Interfaces, V_{CC} bus and other vulnerable circuits used in Telecom, Computer, Industrial and Consumer electronic applications.

SMBLCE-HRA Series

Surface Mount - 600W

Electrical Characteristics

Part Number	Marking Code	Stand-Off Voltage V_R (V)	Minimum Breakdown Voltage $V_{BR}(V)$ @ I_T		Test Current I_T (mA)	Maximum Reverse Leakage at I_R @ V_R (μA)	Maximum Clamping Voltage @ I_{PP} V_C (V)	Maximum Peak Pulse Current per (Fig.3) I_{PP} (A)	Maximum Junction Capacitance at 0 Volts $f=1MHz$ (pF)	Working Inverse Blocking Voltage V_{WIB} (V)	Inverse Blocking Leakage Current at I_{IB} @ V_{WIB} (mA)	Peak Inverse Blocking Voltage V_{PIB} (V)	Agency Approval
			MIN	MAX									
SMBLCE6.5-HRA	SKKH	6.5	7.22	7.98	10	1000	11.2	53.58	50	75	1.0	100	
SMBLCE7.0-HRA	SKMH	7.0	7.78	8.60	10	500	12.0	50.00	50	75	1.0	100	
SMBLCE7.5-HRA	SKPH	7.5	8.33	9.21	10	250	12.9	46.52	50	75	1.0	100	
SMBLCE8.0-HRA	SKRH	8.0	8.89	9.83	1	100	13.6	44.12	50	75	1.0	100	
SMBLCE8.5-HRA	SKTH	8.5	9.44	10.40	1	50	14.4	41.67	50	75	1.0	100	
SMBLCE9.0-HRA	SKVH	9.0	10.00	11.10	1	10	15.4	38.97	50	75	1.0	100	
SMBLCE10-HRA	SKXH	10.0	11.10	12.30	1	5	17.0	35.30	50	75	1.0	100	
SMBLCE11-HRA	SKZH	11.0	12.20	13.50	1	0.96	18.2	32.97	50	75	1.0	100	
SMBLCE12-HRA	SLEH	12.0	13.30	14.70	1	0.96	19.9	30.16	50	75	1.0	100	
SMBLCE13-HRA	SLGH	13.0	14.40	15.90	1	0.96	21.5	27.91	50	75	1.0	100	
SMBLCE14-HRA	SLKH	14.0	15.60	17.20	1	0.96	23.2	25.87	50	75	1.0	100	
SMBLCE15-HRA	SLMH	15.0	16.70	18.50	1	0.96	24.4	24.59	50	75	1.0	100	
SMBLCE16-HRA	SLPH	16.0	17.80	19.70	1	0.96	26.0	23.10	50	75	1.0	100	
SMBLCE17-HRA	SLRH	17.0	18.90	20.90	1	0.96	27.6	21.74	50	75	1.0	100	
SMBLCE18-HRA	SLTH	18.0	20.00	22.10	1	0.96	29.2	20.55	50	75	1.0	100	
SMBLCE20-HRA	SLVH	20.0	22.20	24.50	1	0.96	32.4	18.52	50	75	1.0	100	
SMBLCE22-HRA	SLXH	22.0	24.40	26.90	1	0.96	35.5	16.91	50	75	1.0	100	
SMBLCE24-HRA	SLZH	24.0	26.70	29.50	1	0.96	38.9	15.43	50	75	1.0	100	
SMBLCE26-HRA	SMEH	26.0	28.90	31.90	1	0.96	42.1	14.26	50	75	1.0	100	
SMBLCE28-HRA	SMGH	28.0	31.10	34.40	1	0.96	45.5	13.19	50	75	1.0	100	
SMBLCE30-HRA	SMKH	30.0	33.30	36.80	1	0.96	48.4	12.40	50	75	1.0	100	
SMBLCE33-HRA	SMMH	33.0	36.70	40.60	1	0.96	53.3	11.26	50	75	1.0	100	
SMBLCE36-HRA	SMPH	36.0	40.00	44.20	1	0.96	58.1	10.33	50	75	1.0	100	
SMBLCE40-HRA	SMRH	40.0	44.40	49.10	1	0.96	64.5	9.31	50	75	1.0	100	
SMBLCE43-HRA	SMTH	43.0	47.80	52.80	1	0.96	69.4	8.65	50	75	1.0	100	
SMBLCE45-HRA	SMVH	45.0	50.00	55.30	1	0.96	72.7	8.26	50	75	1.0	100	
SMBLCE48-HRA	SMXH	48.0	53.30	58.90	1	0.96	77.4	7.76	50	75	1.0	100	
SMBLCE51-HRA	SMZH	51.0	56.70	62.70	1	0.96	82.4	7.29	50	75	1.0	100	
SMBLCE54-HRA	SNEH	54.0	60.00	66.30	1	0.96	87.1	6.90	50	100	1.0	125	
SMBLCE58-HRA	SNGH	58.0	64.40	71.20	1	0.96	93.6	6.42	50	100	1.0	125	
SMBLCE60-HRA	SNKH	60.0	66.70	73.70	1	0.96	96.8	6.20	50	100	1.0	125	
SMBLCE64-HRA	SNMH	64.0	71.10	78.60	1	0.96	103.0	5.83	50	100	1.0	125	
SMBLCE70-HRA	SNPH	70.0	77.80	86.00	1	0.96	113.0	5.31	50	125	1.0	150	

Screen Process

100% Vision Inspection	MIL-STD-750 method 2074
100% X-RAY inspection	MIL-STD-750 method 2076
100% Temperature Cycle Test (-55 to 150°C, 20 cycles, dwell time 15 min)	MIL-STD-750 method 1051
100% Reflow (2x)	JEDEC J-STD-020
100% Surge Test (2x)	MIL-STD-750 method 4066
100% HTRB 150°C Bias=V_R (80% breakdown voltage, 96hrs)	MIL-STD-750 method 1038
Final Electrical Test(100% 3 sigma limit, 100% dynamic test and PAT limit)	MIL-STD-750 method 4016.4021.4011

Note: Up-screen program can be specified by customer's request by contacting Littelfuse customer service

SMBLCE-HRA Series

Surface Mount - 600W

Ratings and Characteristic Curves ($T_A=25^{\circ}\text{C}$ unless otherwise noted)

Figure 1 - Peak Pulse Power Rating Curve

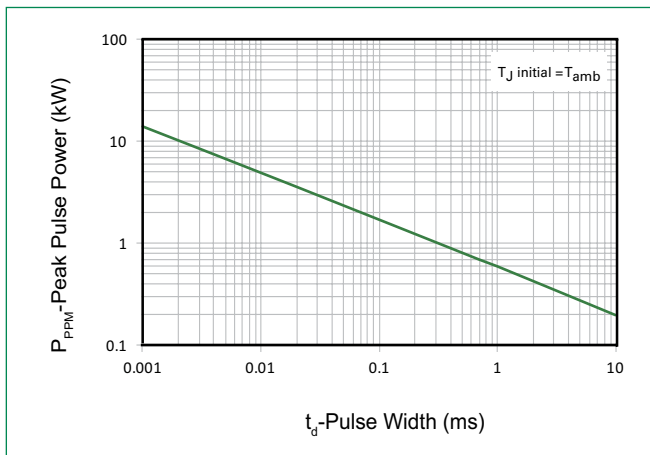

Figure 2 - Peak Pulse Power Derating Curve

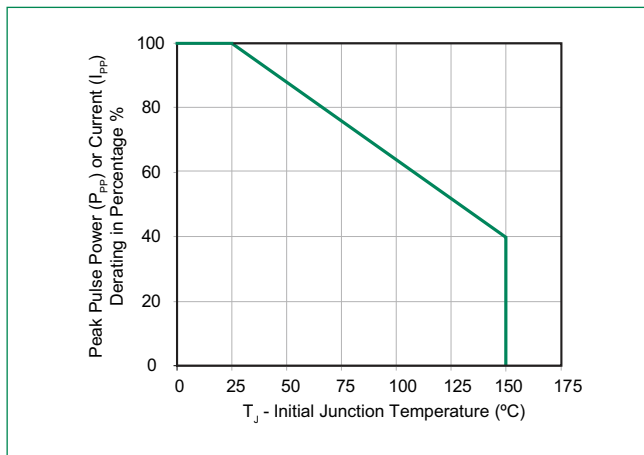

Figure 3 - Pulse Waveform

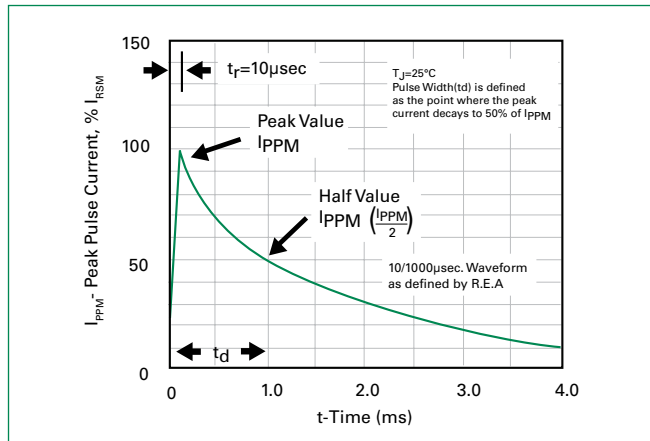
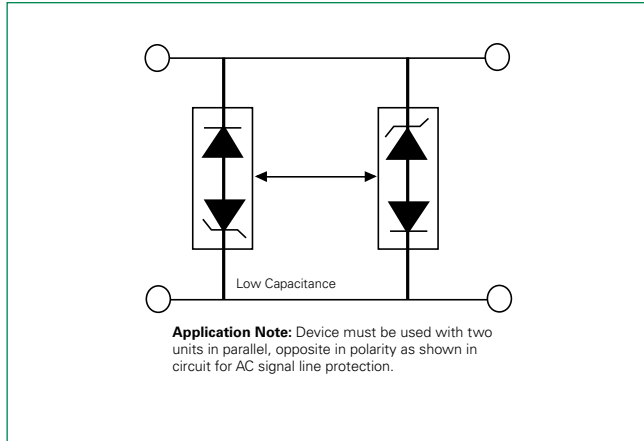

Figure 4 - AC Line Protection Application



SMBLCE-HRA Series

Surface Mount - 600W

Soldering Parameters

Reflow Condition		Lead-free assembly
Pre Heat	- Temperature Min ($T_{s(min)}$)	150°C
	- Temperature Max ($T_{s(max)}$)	200°C
	- Time (min to max) (t_s)	60 – 180 secs
Average ramp up rate (Liquidus Temp (T_L) to peak)		3°C/second max
$T_{s(max)}$ to T_L - Ramp-up Rate		3°C/second max
Reflow	- Temperature (T_L) (Liquidus)	217°C
	- Time (min to max) (t_s)	60 – 150 seconds
Peak Temperature (T_p)		260 ^{+0/-5} °C
Time within 5°C of actual peak Temperature (t_p)		20 – 40 seconds
Ramp-down Rate		6°C/second max
Time 25°C to peak Temperature (T_p)		8 minutes max.
Do not exceed		260°C

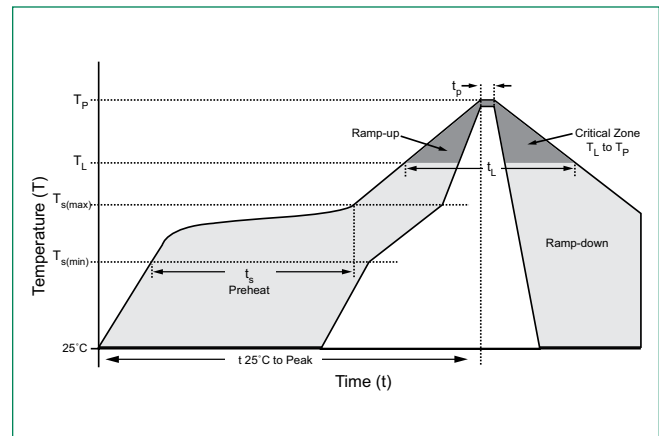

Physical Specifications

Weight	0.003oz., 0.093g
Case	JEDEC DO-214AA molded plastic body over glass passivated junction.
Polarity	Color band denotes cathode except Bidirectional
Terminal	Matte Tin-plated leads. Solderable per JESD22-B102

Environmental Specifications

High Temp. Storage	JESD22-A103
HTRB	JESD22-A108
Temperature Cycling	JESD22-A104
MSL	JEDEC-J-STD-020, Level 1
H3TRB	JESD22-A101
RSH	JESD22-A111

Dimensions

DO-214AA (SMB J-Bend)

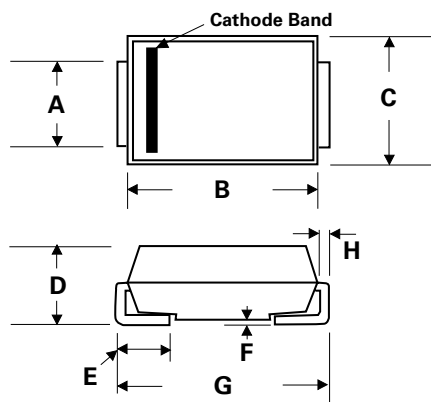

Dimensions	Inches		Millimeters	
	Min	Max	Min	Max
A	0.077	0.086	1.950	2.200
B	0.160	0.180	4.060	4.570
C	0.130	0.155	3.300	3.940
D	0.084	0.096	2.130	2.440
E	0.030	0.060	0.760	1.520
F	-	0.008	-	0.203
G	0.205	0.220	5.210	5.590
H	0.006	0.012	0.152	0.305

SMBLCE-HRA Series

Surface Mount - 600W

Part Numbering System

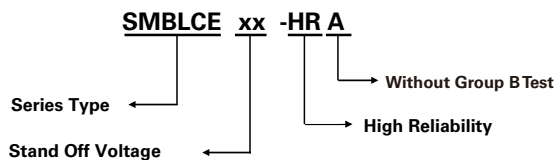

Part Marking System

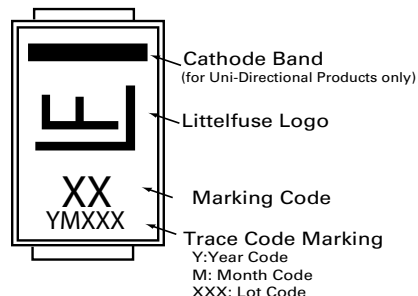

Packaging

Part number	Component Package	Quantity	Packaging Option	Packaging Specification
SMBLCE-HRA	DO-214AA	500	Tape & Reel - 16mm tape/7" reel	EIA STD RS-481

Tape and Reel Specification

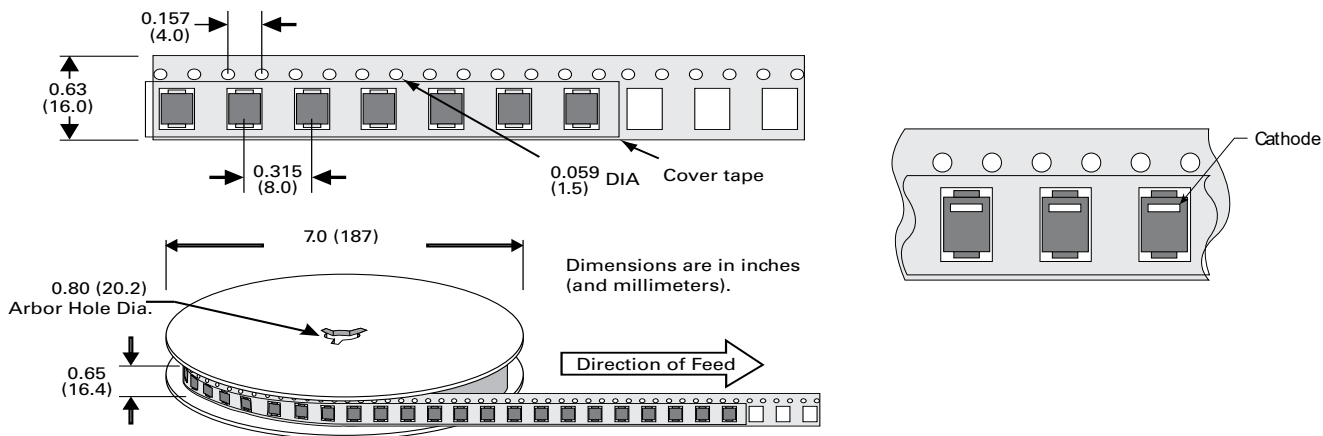

Disclaimer Notice - Information furnished is believed to be accurate and reliable. However, users should independently evaluate the suitability of and test each product selected for their own applications. Littelfuse products are not designed for, and may not be used in, all applications. Read complete Disclaimer Notice at <http://www.littelfuse.com/disclaimer-electronics>.