

# TrenchT2™ Power MOSFET

# IXTH360N055T2 IXTT360N055T2

$V_{DSS} = 55V$   
 $I_{D25} = 360A$   
 $R_{DS(on)} \leq 2.4m\Omega$

N-Channel Enhancement Mode  
 Avalanche Rated  
 Fast Intrinsic Diode

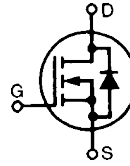

TO-268  
(IXTT)

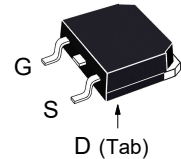

TO-247  
(IXTH)

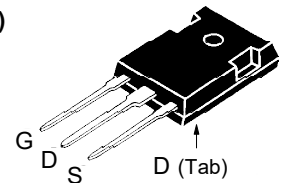

G = Gate      D = Drain  
 S = Source    Tab = Drain

Symbol	Test Conditions	Maximum Ratings	
$V_{DSS}$	$T_J = 25^\circ C$ to $175^\circ C$	55	V
$V_{DGR}$	$T_J = 25^\circ C$ to $175^\circ C$ , $R_{GS} = 1M\Omega$	55	V
$V_{GSM}$	Transient	$\pm 20$	V
$I_{D25}$	$T_C = 25^\circ C$ (Chip Capability)	360	A
$I_{LRMS}$	Lead Current Limit, RMS	160	A
$I_{DM}$	$T_C = 25^\circ C$ , Pulse Width Limited by $T_{JM}$	900	A
$I_A$	$T_C = 25^\circ C$	180	A
$E_{AS}$	$T_C = 25^\circ C$	960	mJ
$P_D$	$T_C = 25^\circ C$	935	W
$T_J$		-55 ... +175	$^\circ C$
$T_{JM}$		175	$^\circ C$
$T_{stg}$		-55 ... +175	$^\circ C$
$T_L$	Maximum Lead Temperature for Soldering	300	$^\circ C$
$T_{SOLD}$	Plastic Body for 10s	260	$^\circ C$
$M_d$	Mounting Torque (TO-247)	1.13 / 10	Nm/lb.in.
Weight	TO-247	6	g
	TO-268	4	g

### Features

- International Standard Package
- $175^\circ C$  Operating Temperature
- High Current Handling Capability
- Avalanche Rated
- Fast Intrinsic Diode
- Low  $R_{DS(on)}$

### Advantages

- Easy to Mount
- Space Savings
- High Power Density

### Applications

- DC/DC Converters and Off-line UPS
- Primary- Side Switch
- High Current Switching Applications

Symbol	Test Conditions ( $T_J = 25^\circ C$ Unless Otherwise Specified)	Characteristic Values		
		Min.	Typ.	Max.
$BV_{DSS}$	$V_{GS} = 0V$ , $I_D = 250\mu A$	55		V
$V_{GS(th)}$	$V_{DS} = V_{GS}$ , $I_D = 250\mu A$	2.0		4.0 V
$I_{GSS}$	$V_{GS} = \pm 20V$ , $V_{DS} = 0V$			$\pm 200$ nA
$I_{DSS}$	$V_{DS} = V_{DSS}$ , $V_{GS} = 0V$ $T_J = 150^\circ C$			10 $\mu A$
				300 $\mu A$
$R_{DS(on)}$	$V_{GS} = 10V$ , $I_D = 100A$ , Note 1			2.4 m $\Omega$

Symbol	Test Conditions ( $T_J = 25^\circ\text{C}$ , Unless Otherwise Specified)	Characteristic Values		
		Min.	Typ.	Max.
$g_{fs}$	$V_{DS} = 10\text{V}, I_D = 60\text{A}$ , Note 1	65	110	S
$C_{iss}$	} $V_{GS} = 0\text{V}, V_{DS} = 25\text{V}, f = 1\text{MHz}$		20	nF
$C_{oss}$			2650	pF
$C_{rss}$			480	pF
$R_{Gi}$	Gate Input Resistance		1.6	$\Omega$
$t_{d(on)}$	} <b>Resistive Switching Times</b> $V_{GS} = 10\text{V}, V_{DS} = 0.5 \cdot V_{DSS}, I_D = 100\text{A}$ $R_G = 2\Omega$ (External)		30	ns
$t_r$			23	ns
$t_{d(off)}$			62	ns
$t_f$			56	ns
$Q_{g(on)}$	} $V_{GS} = 10\text{V}, V_{DS} = 0.5 \cdot V_{DSS}, I_D = 0.5 \cdot I_{D25}$		330	nC
$Q_{gs}$			76	nC
$Q_{gd}$			87	nC
$R_{thJC}$				0.16 $^\circ\text{C/W}$
$R_{thCH}$	TO-247		0.21	$^\circ\text{C/W}$

**Source-Drain Diode**

Symbol	Test Conditions ( $T_J = 25^\circ\text{C}$ , Unless Otherwise Specified)	Characteristic Values		
		Min.	Typ.	Max.
$I_S$	$V_{GS} = 0\text{V}$			360 A
$I_{SM}$	Repetitive, Pulse Width Limited by $T_{JM}$			1440 A
$V_{SD}$	$I_F = 100\text{A}, V_{GS} = 0\text{V}$ , Note 1			1.3 V
$t_{rr}$	} $I_F = 150\text{A}, V_{GS} = 0\text{V}$ $-di/dt = 100\text{A}/\mu\text{s}$ $V_R = 27\text{V}$		78	ns
$I_{RM}$			4.2	A
$Q_{RM}$			164	nC

Note 1. Pulse test,  $t \leq 300\mu\text{s}$ ; duty cycle,  $d \leq 2\%$ .

Littelfuse reserves the right to change limits, test conditions, and dimensions.

IXYS MOSFETs and IGBTs are covered	4,835,592	4,931,844	5,049,961	5,237,481	6,162,665	6,404,065B1	6,683,344	6,727,585	7,005,734B2	7,157,338B2
by one or more of the following U.S. patents:	4,860,072	5,017,508	5,063,307	5,381,025	6,259,123B1	6,534,343	6,710,405B2	6,759,692	7,063,975B2	
	4,881,106	5,034,796	5,187,117	5,486,715	6,306,728 B1	6,583,505	6,710,463	6,771,478 B2	7,071,537	

**Fig. 1. Output Characteristics @  $T_J = 25^\circ\text{C}$**

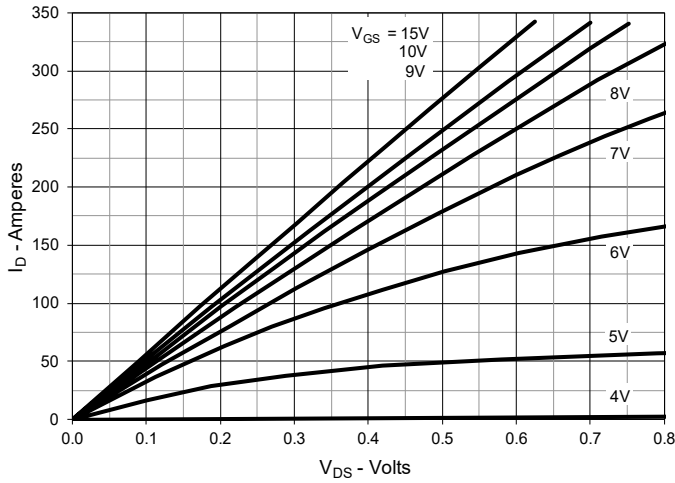

**Fig. 2. Extended Output Characteristics @  $T_J = 25^\circ\text{C}$**

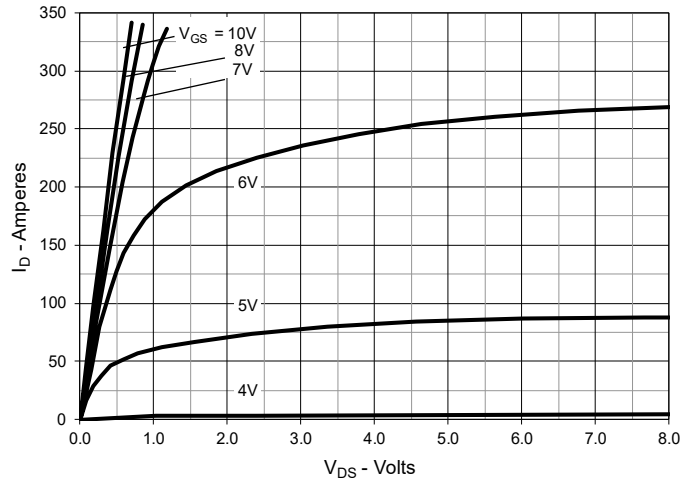

**Fig. 3. Output Characteristics @  $T_J = 150^\circ\text{C}$**

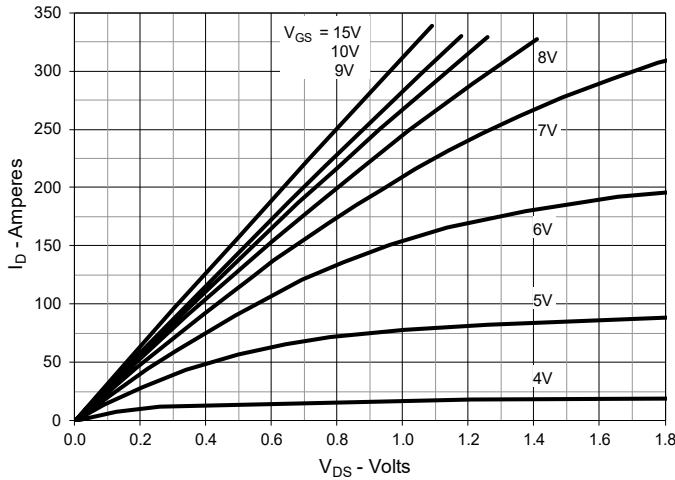

**Fig. 4.  $R_{DS(on)}$  Normalized to  $I_D = 180\text{A}$  Value vs. Junction Temperature**

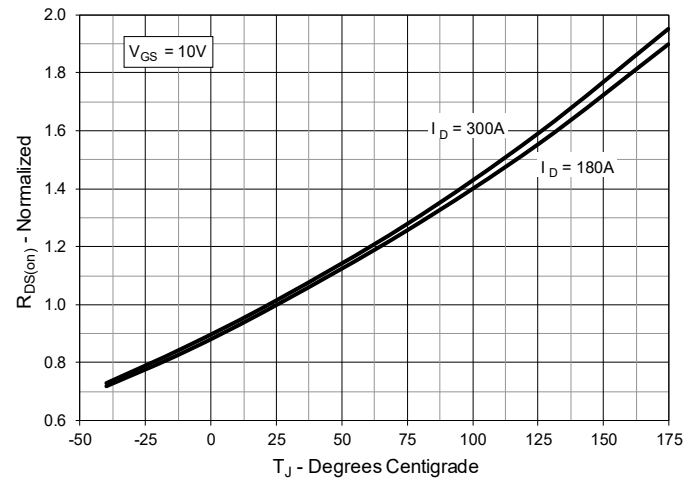

**Fig. 5.  $R_{DS(on)}$  Normalized to  $I_D = 180\text{A}$  Value vs. Drain Current**

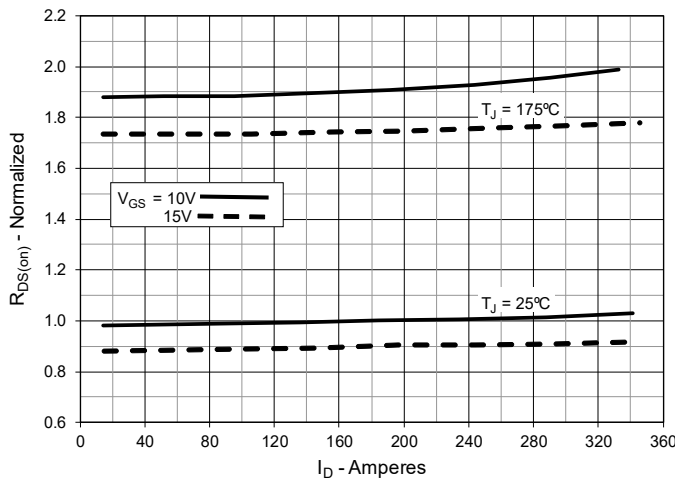

**Fig. 6. Drain Current vs. Case Temperature**

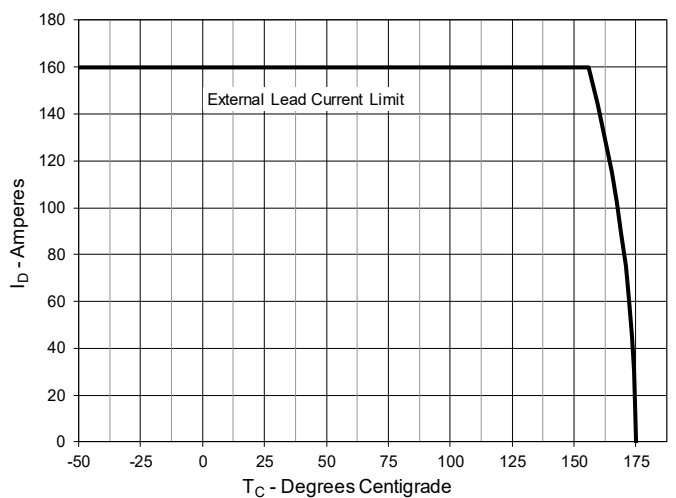

**Fig. 7. Input Admittance**

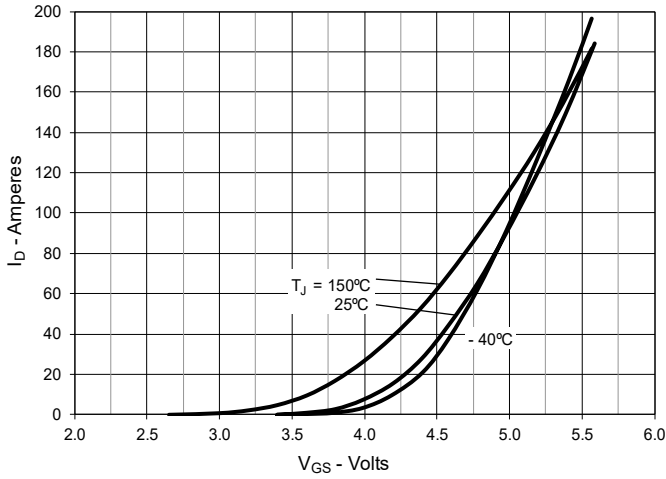

**Fig. 8. Transconductance**

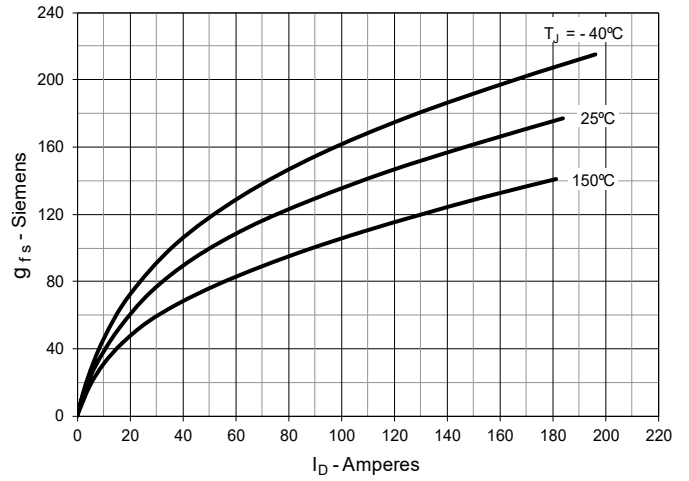

**Fig. 9. Forward Voltage Drop of Intrinsic Diode**

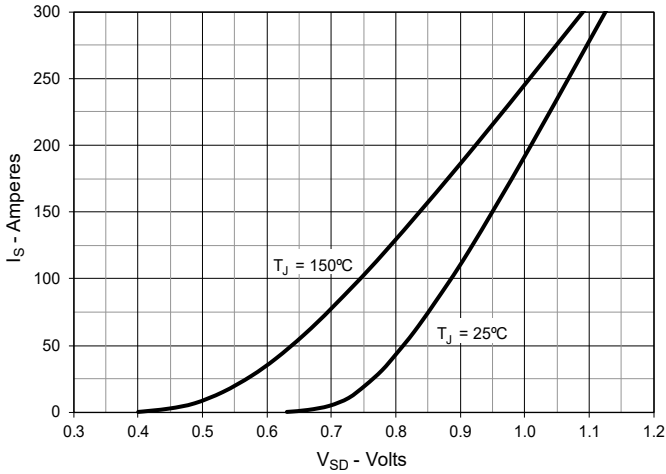

**Fig. 10. Gate Charge**

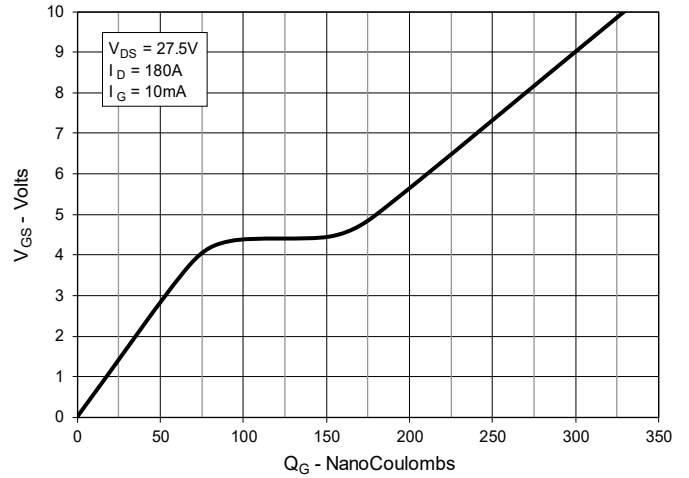

**Fig. 11. Capacitance**

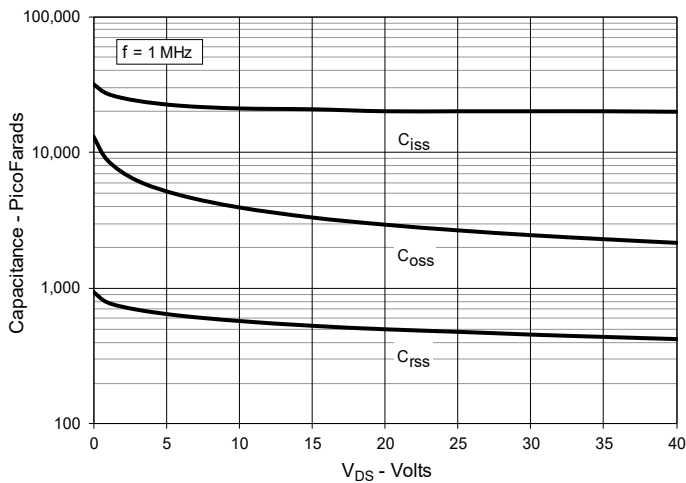

**Fig. 12. Forward-Bias Safe Operating Area**

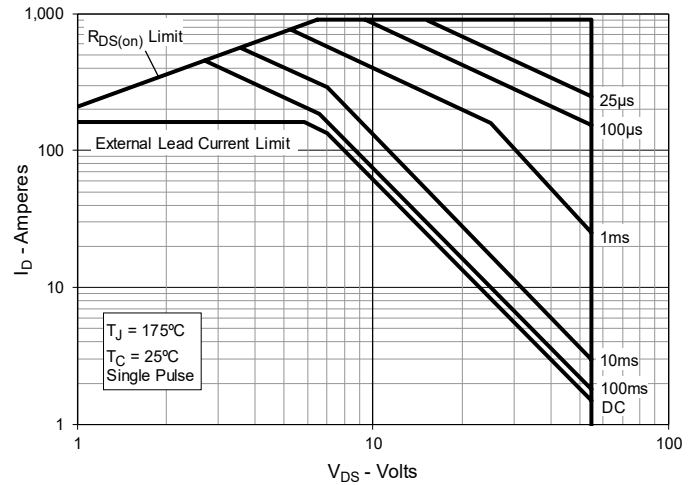

Fig. 13. Resistive Turn-on Rise Time vs. Junction Temperature

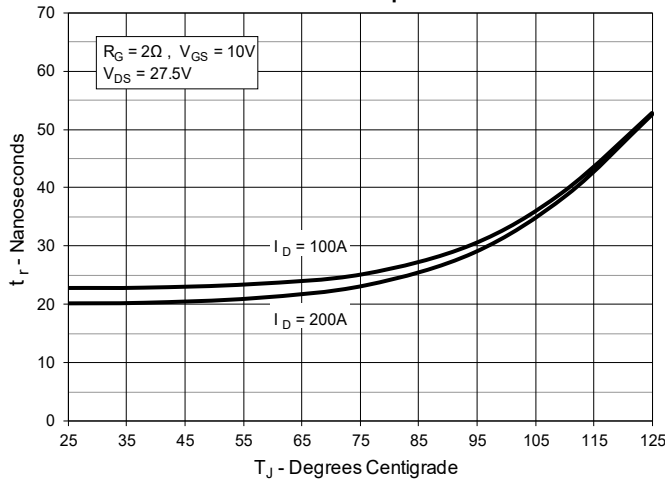

Fig. 14. Resistive Turn-on Rise Time vs. Drain Current

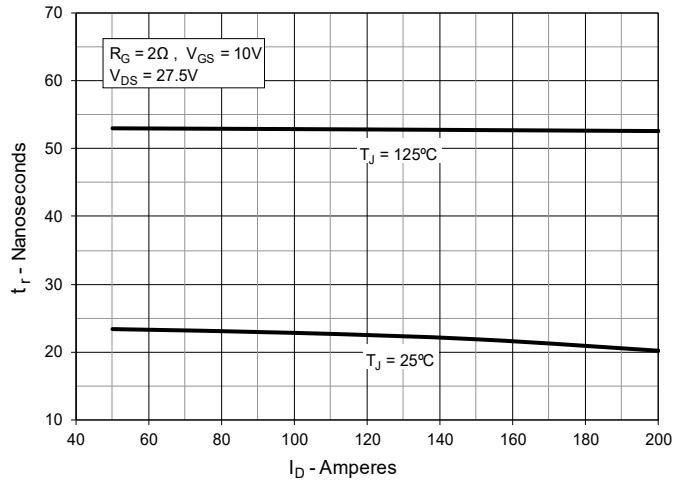

Fig. 15. Resistive Turn-on Switching Times vs. Gate Resistance

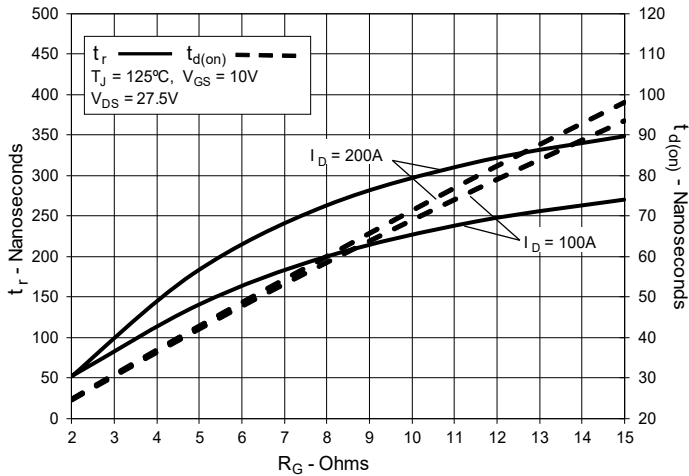

Fig. 16. Resistive Turn-off Switching Times vs. Junction Temperature

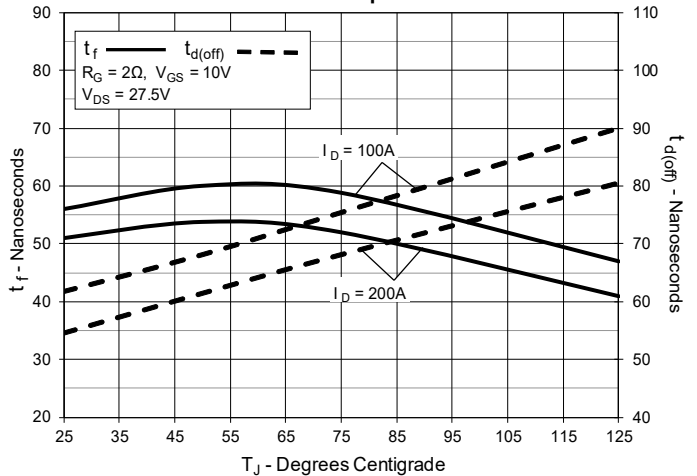

Fig. 17. Resistive Turn-off Switching Times vs. Drain Current

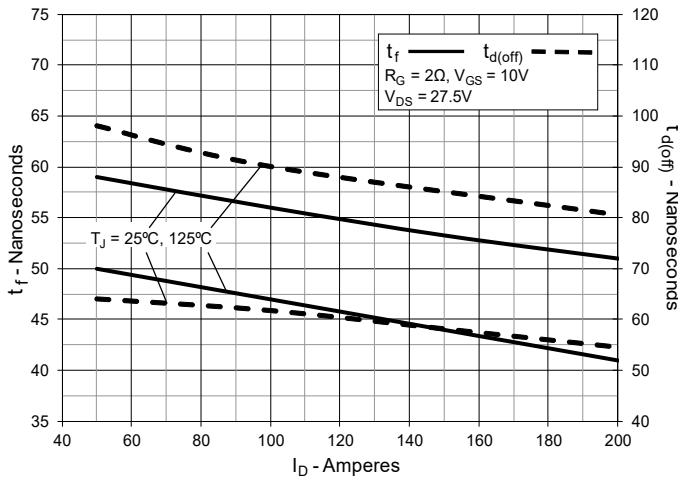
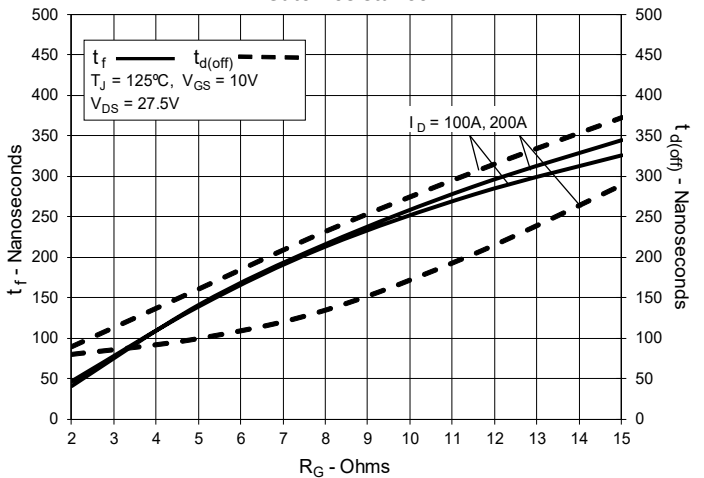
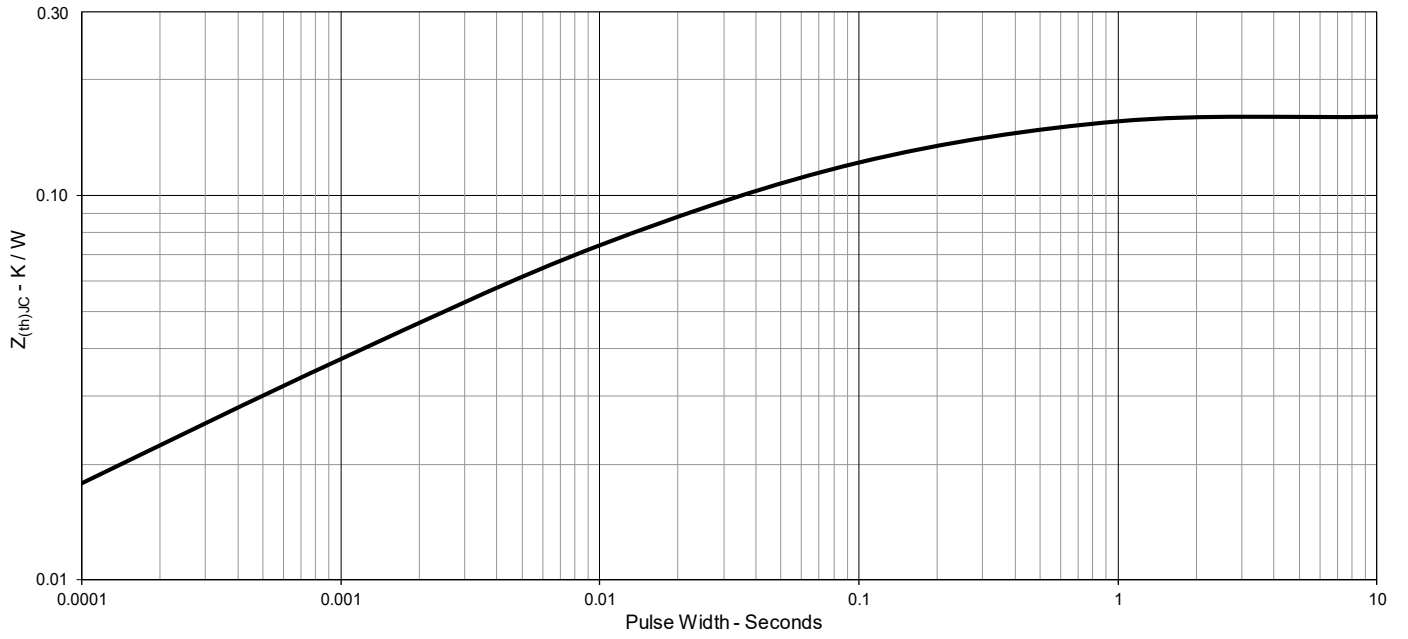

Fig. 18. Resistive Turn-off Switching Times vs. Gate Resistance



**Fig. 19. Maximum Transient Thermal Impedance**



### TO-268 Outline

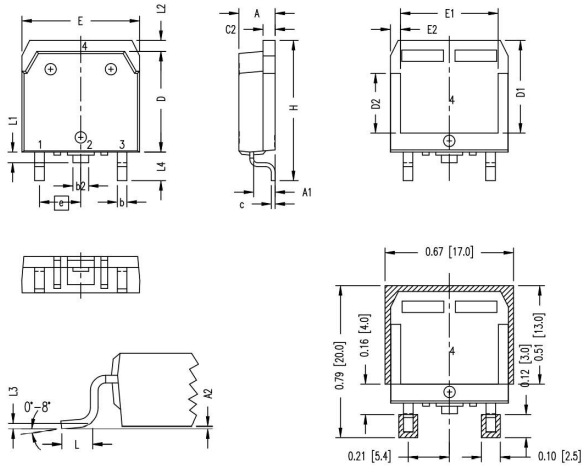

- 1 - Gate
- 2,4 - Drain
- 3 - Source

SYM	Inches		Millimeters	
	MIN	MAX	MIN	MAX
A	0.193	0.201	4.90	5.10
A1	0.106	0.114	2.70	2.90
A2	0.001	0.010	0.02	0.25
b	0.045	0.057	1.15	1.45
b2	0.075	0.083	1.90	2.10
c	0.016	0.026	0.40	0.65
C2	0.057	0.063	1.45	1.60
D	0.543	0.551	13.80	14.00
D1	0.488	0.500	12.40	12.70
D2	0.320	0.335	8.13	8.50
E	0.624	0.632	15.85	16.05
E1	0.524	0.535	13.30	13.60
E2	0.045	0.055	1.14	1.39
e	0.215	BSC	5.45	BSC
H	0.736	0.752	18.70	19.10
L	0.094	0.106	2.40	2.70
L1	0.047	0.055	1.20	1.40
L2	0.039	0.045	1.000	1.15
L3	0.010	BSC	0.25	BSC
L4	0.150	0.161	3.80	4.10

### TO-247 Outline

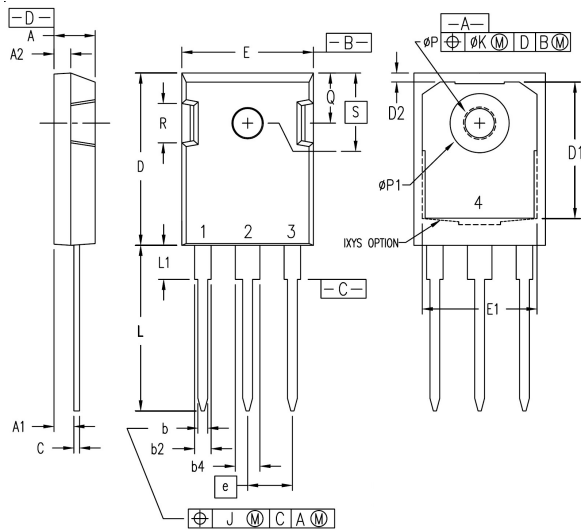

- 1 - Gate
- 2,4 - Drain
- 3 - Source

SYM	INCHES		INCHES	
	MIN	MAX	MIN	MAX
A	0.190	0.205	4.83	5.21
A1	0.090	0.100	2.29	2.54
A2	0.075	0.085	1.91	2.16
b	0.045	0.055	1.14	1.40
b2	0.075	0.087	1.91	2.20
b4	0.115	0.126	2.92	3.20
C	0.024	0.031	0.61	0.80
D	0.819	0.840	20.80	21.34
D1	0.650	0.690	16.51	17.53
D2	0.035	0.050	0.89	1.27
E	0.620	0.635	15.57	16.13
E1	0.545	0.565	13.84	14.35
e	0.215 BSC		5.45 BSC	
J	--	0.010	--	0.250
K	--	0.025	--	0.640
L	0.780	0.810	19.81	20.57
L1	0.150	0.170	3.81	4.32
ØP	0.140	0.144	3.55	3.65
ØP1	0.275	0.290	6.99	7.37
Q	0.220	0.244	5.59	6.20
R	0.170	0.190	4.32	4.83
S	0.242 BSC		6.15 BSC	



Disclaimer Notice - Information furnished is believed to be accurate and reliable. However, users should independently evaluate the suitability of and test each product selected for their own applications. Littelfuse products are not designed for, and may not be used in, all applications. Read complete Disclaimer Notice at [www.littelfuse.com/disclaimer-electronics](http://www.littelfuse.com/disclaimer-electronics).  
Littelfuse reserves the right to change limits, test conditions, and dimensions.

---