

DSSK38-0025BS

25 V, 38 A Schottky Rectifier Diode

RoHS

Pb

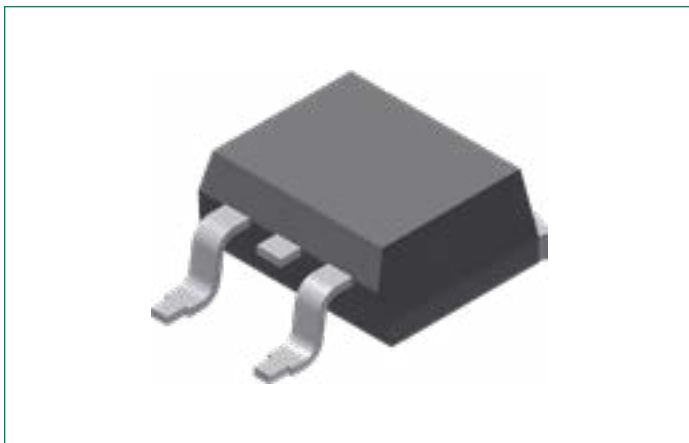

Features:

- Very low V_F
- Extremely low switching losses
- Low I_{RM} values
- Improved thermal behavior
- High reliability circuit operation
- Low voltage peaks for reduced protection circuits
- Low noise switching
- Terminals finish: 100% pure tin
- This is a Pb-free device
- Epoxy meets UL 94 V-0

Pinout Diagram (TO-263AB)

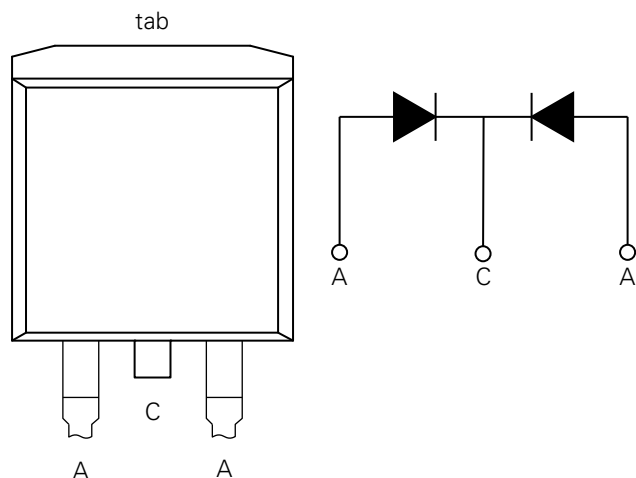

C: Cathode; **A:** Anode; **tab:** Cathode

Applications:

- Rectifiers in switch mode power supplies (SMPS)
- Free wheeling diode in low voltage converters

Product Summary

Characteristic	Value	Unit
V_{RRM}	25	V
I_{FAV}	2 x 20	A
V_F	0.40	V

Maximum Ratings ($T_A = 25^\circ\text{C}$ unless otherwise specified)

Symbol	Characteristics	Condition	Max.	Units
V_{RRM}	Peak Repetitive Reverse Voltage	–	25	V
V_{RWM}	Working Peak Reverse Voltage			
V_R	DC Blocking Voltage			
I_{FAV}	Average Rectified Forward Current	50% duty cycle @ $T_C = 130^\circ\text{C}$, rectangular wave form	20 (Per Leg) 40 (Per Device)	A
I_{FSM}	Peak One Cycle Non-Repetitive Surge Current (Per Leg)	10 ms, Half Sine pulse, $T_{VJ} = 25^\circ\text{C}$	300	A
P_{tot}	Total Power Dissipation	$T_C = 25^\circ\text{C}$	90	W

Electrical Characteristics ($T_A = 25^\circ\text{C}$ unless otherwise specified)

Symbol	Characteristics	Conditions	Typ.	Max.	Units
V_{F1}	Forward Voltage Drop (Per Leg) ¹	@ 20 A, Pulse, $T_{VJ} = 25^\circ\text{C}$	–	0.48	V
V_{F1}		@ 20 A, Pulse, $T_{VJ} = 125^\circ\text{C}$	–	0.40	V
I_{R1}	Reverse Current (Per Leg)*	@ $V_R = \text{rated } V_R$, $T_{VJ} = 25^\circ\text{C}$	–	20	mA
I_{R2}		@ $V_R = \text{rated } V_R$, $T_{VJ} = 100^\circ\text{C}$	–	80	mA
C_T	Junction Capacitance (Per Leg)	@ $V_R = 5\text{ V}$, $T_C = 25^\circ\text{C}$ $f_{SIG} = 1\text{ MHz}$	1170	–	pF

Note 1: Pulse width < 300 μs , duty cycle < 2%

Thermal-Mechanical Specifications

Symbol	Characteristics	Condition	Specification	Units
T_{VJ}	Junction Temperature	–	-55 to +150	$^\circ\text{C}$
T_O	Operation Temperature	–	-55 to +125	$^\circ\text{C}$
T_{stg}	Storage Temperature	–	-55 to +150	$^\circ\text{C}$
F_C	Mounting force with clip	–	Min 20 Max 60	N
R_{thJC}	Maximum Thermal Resistance Junction to Case	DC operation	1.40	K/W
R_{thCS}	Typical Thermal Resistance Case to Heat Sink	–	0.50	K/W
wt	Approximate Weight	–	1.85	g

Characteristic Curves

Fig. 1. Typical Forward Characteristics

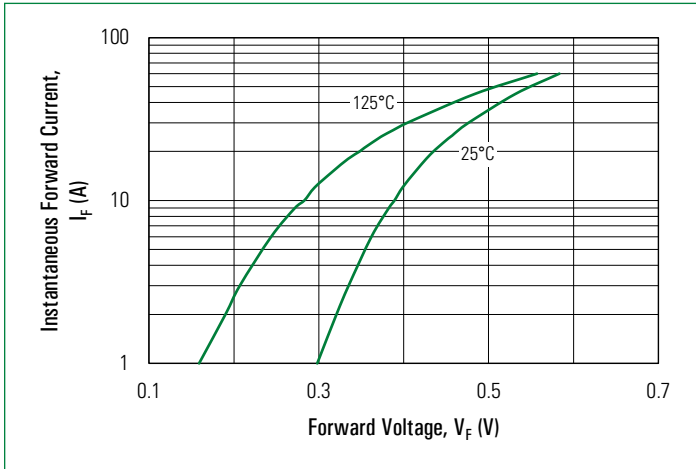

Fig. 2. Typical Reverse Characteristics

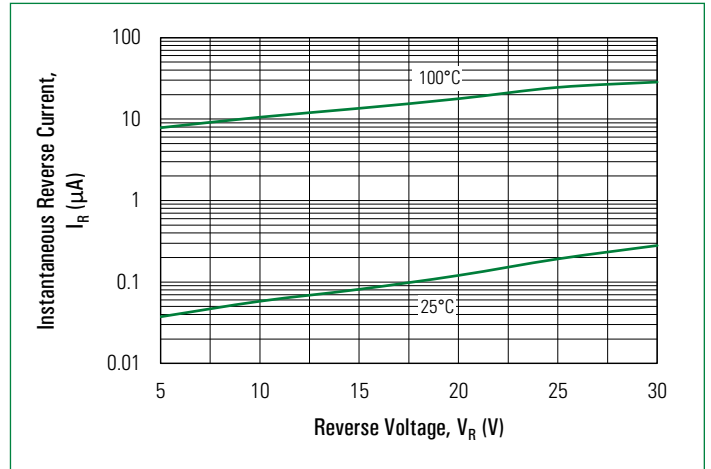
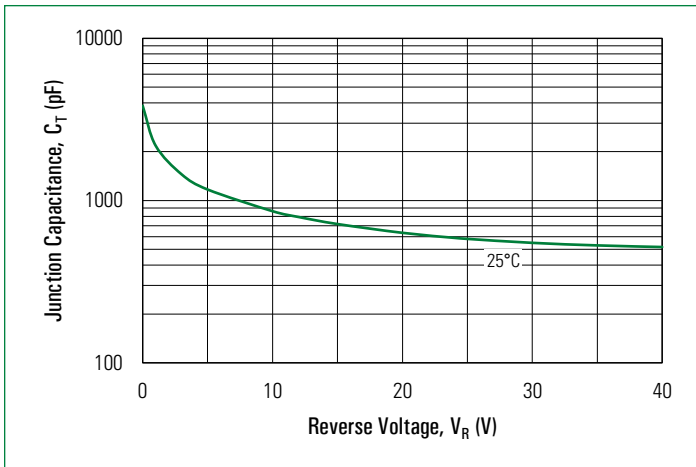
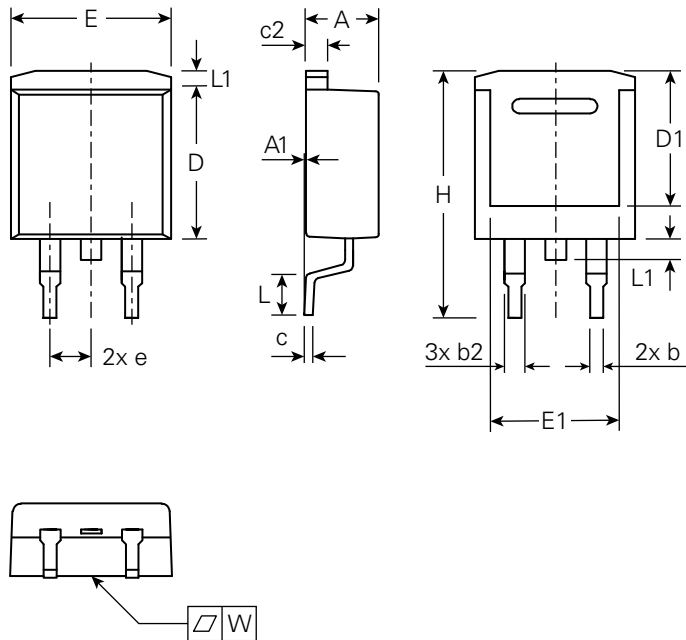

Fig. 3. Typical Junction Capacitance



Part Outline Drawing (TO-263AB)



Symbol	Inches			Millimeters		
	Min.	Typical	Max.	Min.	Typical	Max.
A	0.16	-	0.19	4.06	-	4.83
A1	0	-	0.010	0	-	0.26
b	0.020	-	0.039	0.51	-	0.99
b1	0.045	-	0.070	1.14	-	1.78
c	0.012	-	0.029	0.31	-	0.74
c1	0.045	-	0.064	1.14	-	1.65
D	0.330	-	0.379	8.38	-	9.65
D1	0.251	-	-	6.40	-	-
E1	0.244	-	-	6.22	-	-
E2	0.379	-	0.420	9.65	-	10.67
e	0.100 BSC			2.54 BSC		
H	0.575	-	0.625	14.61	-	15.88
L	0.070	-	0.110	1.78	-	2.80
L1	-	-	0.066	-	-	1.68
L2	-	-	0.086	-	-	2.20
L3	0.010 BSC			0.255 BSC		

Part Number and Marking

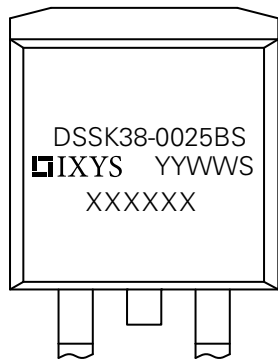

- D = Diode
- S = Schottky Diode
- SK = Product Generation
- 38 = Current Rate
- 0025 = Voltage Rating
- BS = Package Code
- YY = Year
- WW = Work Week
- S = Plant Location Code
- XXXXXX = Lot Number

Ordering Information

Part Number	Marking	Packing Mode	Quantity
DSSK38-0025BS-TRL	DSSK38-0025BS	Reel	800 pcs/ reel

Carrier Tape Specification (TO-263AB)

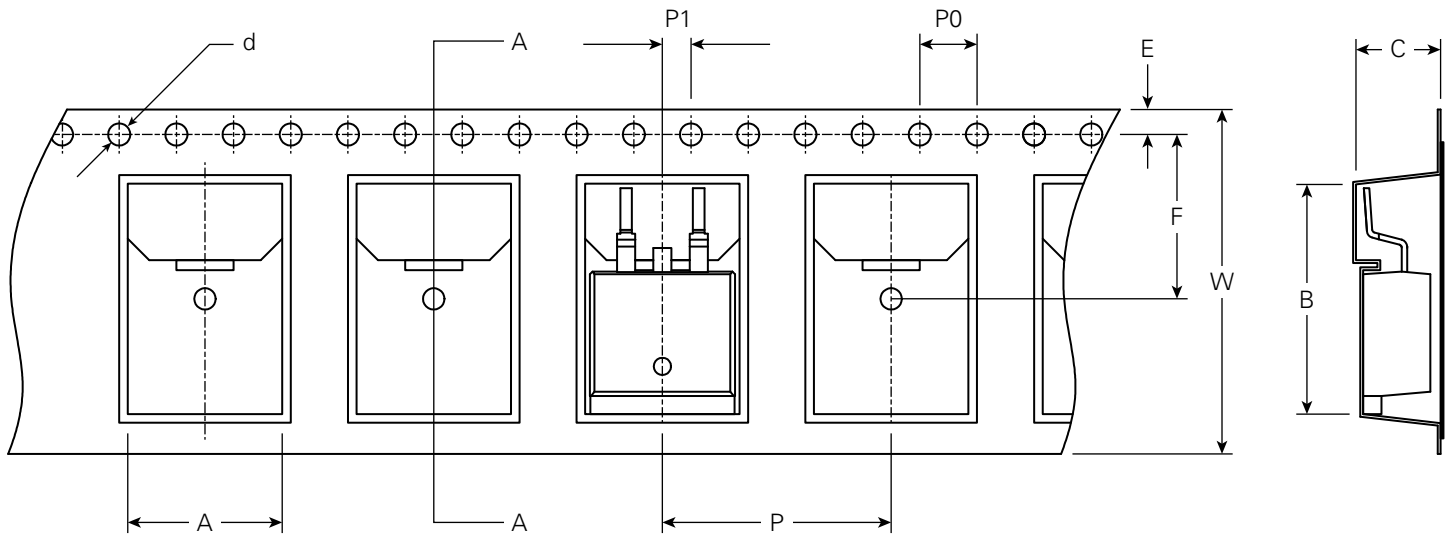

Symbol	Inches			Millimeters		
	Min.	Typical	Max.	Min.	Typical	Max.
A	0.421	-	0.429	10.70	-	10.90
B	0.631	-	0.639	16.03	-	16.23
C	0.201	-	0.209	5.11	-	5.31
d	0.057	-	0.065	1.45	-	1.65
E	0.065	-	0.07	1.65	-	1.85
F	0.449	-	0.457	11.40	-	11.60
P0	0.153	-	0.161	3.90	-	4.10
P	0.626	-	0.664	15.90	-	16.10
P1	0.075	-	0.082	1.90	-	2.10
W	0.941	-	0.957	23.90	-	24.30

Disclaimer Notice

Information furnished is believed to be accurate and reliable. However, users should independently evaluate the suitability of and test each product selected for their own applications. Littelfuse products are not designed for, and may not be used in, all applications. Read complete Disclaimer Notice at <http://www.littelfuse.com/disclaimer-electronics>.



Part of:

