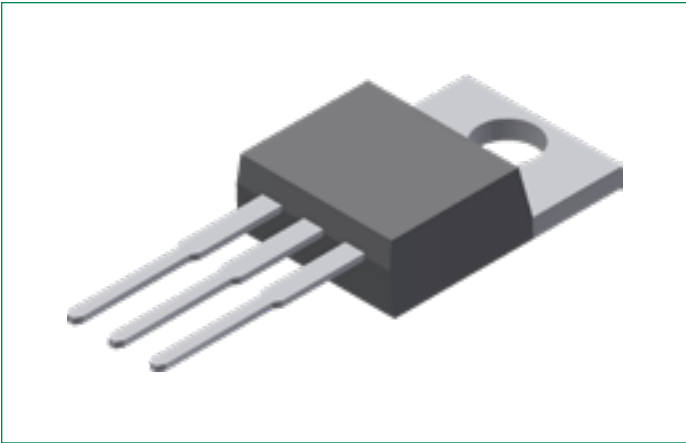

DSSK20-0045B

45 V, 20 A Schottky Rectifier Diode

RoHS

Pb

**Features:**

- Very low V_f
- Extremely low switching losses
- Low I_{rm} values
- Improved thermal behavior
- High reliability circuit operation
- Low voltage peaks for reduced protection circuits
- Low noise switching
- Terminals finish: 100% Pure Tin
- This is a Pb – Free Device
- Epoxy meets UL 94V-0

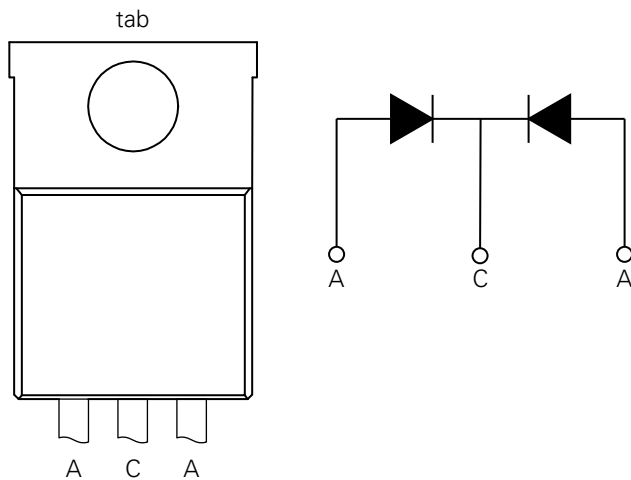
Pinout Diagram (TO-220AB)**C:** Cathode; **A:** Anode; **tab:** Cathode**Applications:**

- Rectifiers in switch mode power supplies (SMPS)
- Free wheeling diode in low voltage converters

Maximum Ratings ($T_A = 25^\circ\text{C}$ unless otherwise specified)

Symbol	Characteristics	Condition	Max.	Units
V_{RRM}	Peak Repetitive Reverse Voltage	–	45	V
V_{RWM}	Working Peak Reverse Voltage			
V_R	DC Blocking Voltage			
$I_{F(AV)}$	Average Rectified Forward Current	50% duty cycle @ $T_C=135^\circ\text{C}$, rectangular wave form	10 (Per Leg) 20 (Per Device)	A
I_{FSM}	Peak One Cycle Non-repetitive Surge Current (Per Leg)	10 ms, Half Sine pulse, $T_J=25^\circ\text{C}$	160	A
P_{tot}	Total power dissipation	$T_C = 25^\circ\text{C}$	75	W
E_{AS}	Non-repetitive Avalanche Energy	$I_{AS} = 20\text{ A}$, $L = 100\ \mu\text{H}$, $T_J=25^\circ\text{C}$	20	mJ
I_{AR}	Repetitive Avalanche Current	$V_A = 1.5 V_R$, typ. $f = 1\text{ kHz}$	2	A

Electrical Characteristics ($T_A = 25^\circ\text{C}$ unless otherwise specified)

Symbol	Characteristics	Conditions	Typ.	Max.	Units
V_{F1}	Forward Voltage Drop (Per Leg) ¹	@ 10A, Pulse, $T_J = 25^\circ\text{C}$	–	0.51	V
V_{F2}		@ 10A, Pulse, $T_J = 125^\circ\text{C}$	–	0.46	V
I_{R1}	Reverse Current (Per Leg)*	@ $V_R = \text{rated } V_R$, $T_J = 25^\circ\text{C}$	–	5	mA
I_{R2}		@ $V_R = \text{rated } V_R$, $T_J = 100^\circ\text{C}$	–	50	mA
C_T	Junction Capacitance (Per Leg)	@ $V_R = 5\text{V}$, $T_C = 25^\circ\text{C}$ $f_{sig} = 1\text{MHz}$	560	–	pF

Note 1: Pulse width < 300 μs , duty cycle < 2%

Thermal-Mechanical Specifications

Symbol	Characteristics	Condition	Specification	Units
T_J	Junction Temperature	–	-55 to +150	$^\circ\text{C}$
T_O	Operation Temperature	–	-55 to +125	$^\circ\text{C}$
T_{stg}	Storage Temperature	–	-55 to +150	$^\circ\text{C}$
M_D	Mounting torque	–	Min 0.4 Max 0.6	Nm
F_C	Mounting force with clip	–	Min 20 Max 60	N
$R_{\theta JC}$	Maximum Thermal Resistance Junction to Case	DC operation	1.7	$^\circ\text{C}/\text{W}$
$R_{\theta CS}$	Typical Thermal Resistance Case to Heat Sink	–	0.5	$^\circ\text{C}/\text{W}$
wt	Approximate Weight	–	2.0	g

Characteristic Curves

Fig. 1. Typical Forward Characteristics

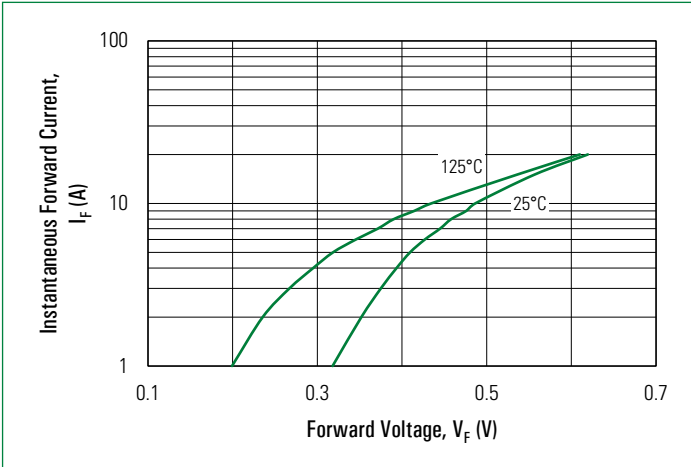

Fig. 2. Typical Reverse Characteristics

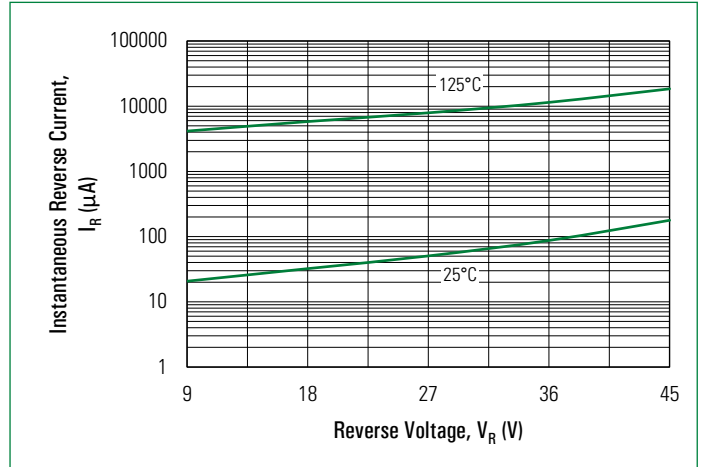
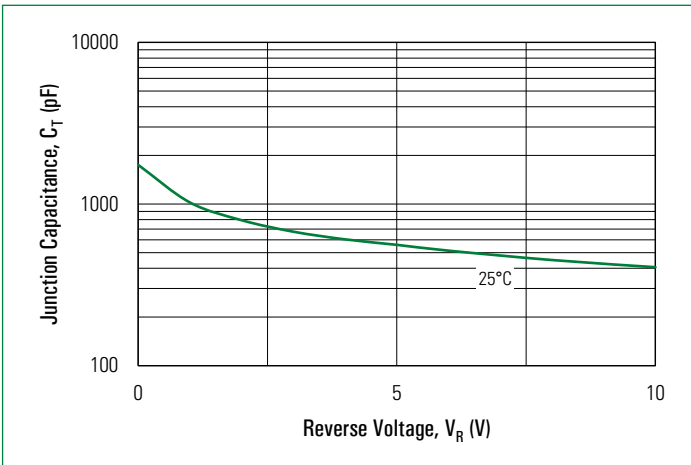
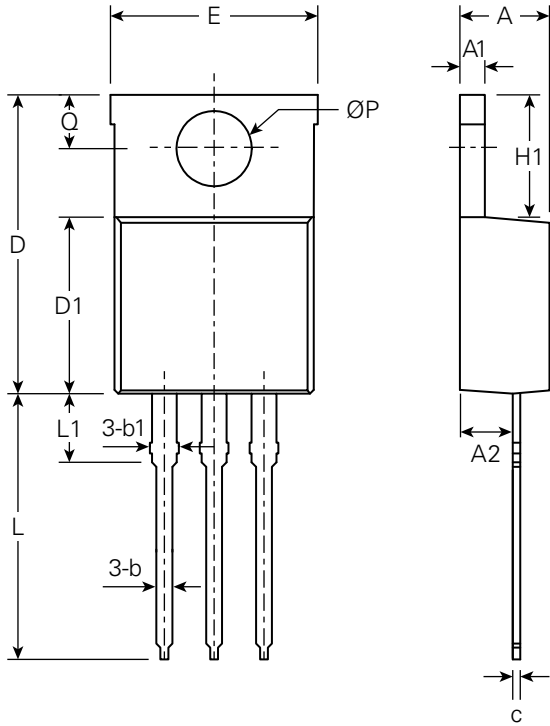

Fig. 3. Typical Junction Capacitance



Part Outline Drawing (TO-220AB)



Symbol	Inches			Millimeters		
	Min.	Typical	Max.	Min.	Typical	Max.
A	0.14	-	0.19	3.56	-	4.83
A1	0.02	-	0.06	0.51	-	1.40
A2	0.08	-	0.11	2.03	-	2.92
b	0.01	-	0.04	0.38	-	1.02
b1	0.44	-	0.07	1.14	-	1.78
c	0.01	-	0.02	0.31	-	0.61
D	0.56	-	0.65	14.22	-	16.51
D1	0.33	-	0.37	8.38	-	9.42
E	0.38	-	0.42	9.65	-	10.67
e	-	0.1	-	-	2.54	-
e1	-	0.20	-	-	5.08	-
H1	0.23	-	0.27	5.84	-	6.86
L	0.50	-	0.58	12.70	-	14.73
L1	-	-	0.25	-	-	6.35
ØP	-	0.14	-	-	3.56	-
Q	0.10	-	0.14	2.54	-	3.43

Part Number and Marking

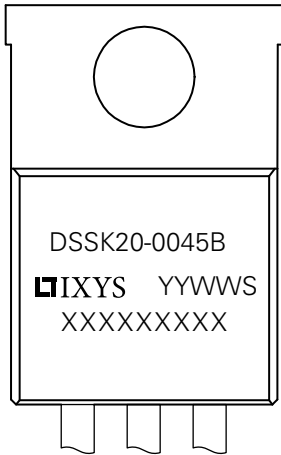

- DS = Schottky Diode
- SK = Product Generation
- 20 = Current Rate
- 0045 = Voltage Rating
- B = Package Code
- YY = Year
- WW = Work Week
- S = Plant Location Code
- XXXXXXXXXX = Lot Number

Ordering Information

Part Number	Marking	Packing Mode	Quantity
DSSK20-0045B	DSSK20-0045B	Tube	50 pcs/ tube

Packing Specifications

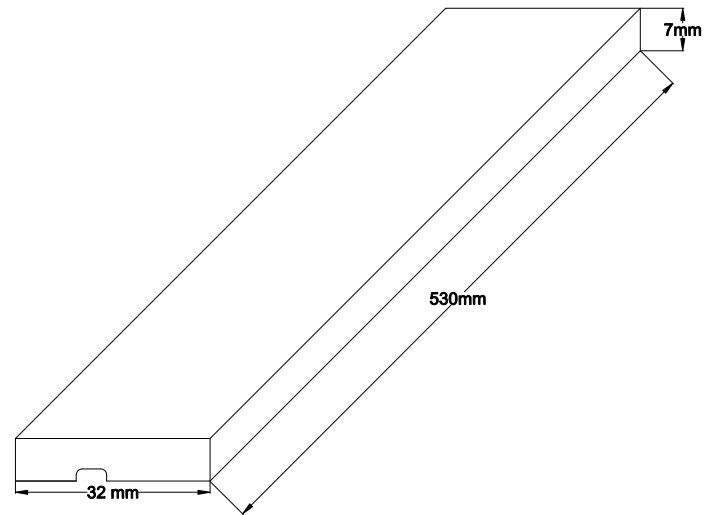

Disclaimer Notice - Information furnished is believed to be accurate and reliable. However, users should independently evaluate the suitability of and test each product selected for their own applications. Littelfuse products are not designed for, and may not be used in, all applications. Read complete Disclaimer Notice at <http://www.littelfuse.com/disclaimer-electronics>.