

DSB20C60PN

60 V, 20 A Schottky Rectifier Diode

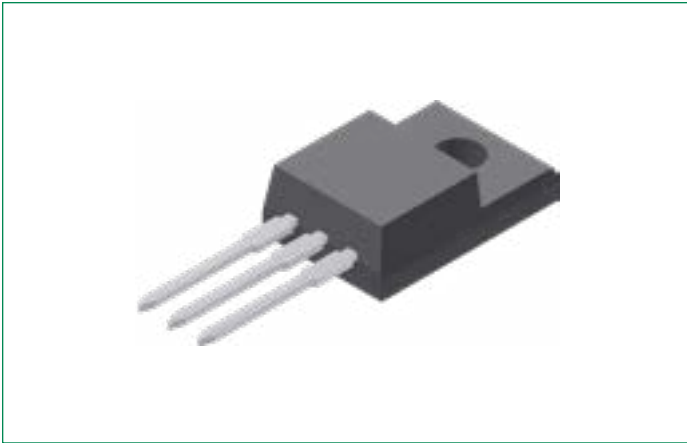

Features:

- Very low V_F
- Extremely low switching losses
- Low I_{RM} values
- Improved thermal behaviour
- High reliability circuit operation
- Low voltage peaks for reduced protection circuits
- Low noise switching
- Terminals finish: 100% pure tin
- This is a Pb-free device
- Epoxy meets UL 94 V-0
- Isolation Voltage: $V \sim 2500$
- Soldering pins for PCB mounting
- Base plate: Plastic over molded tab

Pinout Diagram (TO-220-3L ABFP)

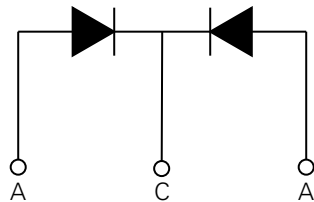
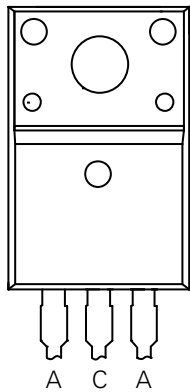

Applications:

- Rectifiers in Switch Mode Power Supplies (SMPS)
- Free wheeling diode in low voltage converters

Product Summary

Characteristic	Value	Unit
V_{RRM}	60	V
I_{FAV}	2 x10	A
V_F	0.62	V

A: Anode; **C:** Cathode

Maximum Ratings ($T_A = 25^\circ\text{C}$ unless otherwise specified)

Symbol	Characteristic	Conditions	Value	Unit	
V_{RRM}	Peak Repetitive Reverse Voltage	-	60	V	
V_{RWM}	Working Peak Reverse Voltage				
V_R	DC Blocking Voltage				
I_{FAV}	Average Rectified Forward Current	50% duty cycle @ $T_C = 110^\circ\text{C}$, rectangular wave form	per leg	10	A
			per device	20	A
I_{FSM}	Peak One Cycle Non-Repetitive Surge Current (per leg)	10 ms, Half Sine pulse, $T_{VJ} = 25^\circ\text{C}$	240	A	
P_{tot}	Total Power Dissipation	$T_C = 25^\circ\text{C}$	28	W	

Electrical Characteristics ($T_{VJ} = 25^\circ\text{C}$ unless otherwise specified)

Symbol	Characteristic	Conditions	Value			Unit
			Min.	Typ.	Max.	
V_{F1}	Forward Voltage Drop (per leg) ¹	@10 A, Pulse, $T_{VJ} = 25^\circ\text{C}$	-	-	0.69	V
V_{F2}		@10 A, Pulse, $T_{VJ} = 125^\circ\text{C}$	-	-	0.62	V
I_{R1}	Reverse Current (per leg) ¹	@ $V_R = \text{rated } V_{R'}$, $T_{VJ} = 25^\circ\text{C}$	-	-	4	mA
I_{R2}		@ $V_R = \text{rated } V_{R'}$, $T_{VJ} = 125^\circ\text{C}$	-	-	35	mA
C_T	Junction Capacitance (per leg)	@ $V_R = 12\text{ V}$, $T_C = 25^\circ\text{C}$, $f_{sig} = 1\text{ MHz}$	-	216	-	pF
V_{ISO}	Isolation Voltage	$t = 1\text{ sec.}$, 50/60 Hz. RMS; $I_{ISOL} \leq 1\text{ mA}$	2500	-	-	V
		$t = 1\text{ min.}$, 50/60 Hz. RMS; $I_{ISOL} \leq 1\text{ mA}$	2100	-	-	

Note 1: Pulse width < 300 μs , duty cycle < 2%

Thermal-Mechanical Specifications

Symbol	Characteristics	Condition	Specification	Units
T_{VJ}	Junction Temperature	-	-55 to +150	$^\circ\text{C}$
T_O	Operation Temperature	-	-55 to +125	$^\circ\text{C}$
T_{stg}	Storage Temperature	-	-55 to +150	$^\circ\text{C}$
M_D	Mounting torque	-	Min 0.4 Max 0.6	Nm
F_C	Mounting force with clip	-	Min 20 Max 60	N
R_{thJC}	Maximum Thermal Resistance Junction to Case	DC operation	4.5	K/W
R_{thCS}	Typical Thermal Resistance Case to Heat Sink	-	0.50	K/W
wt	Approximate Weight	-	2	g

Characteristic Curves

Fig. 1. Typical Forward Characteristics

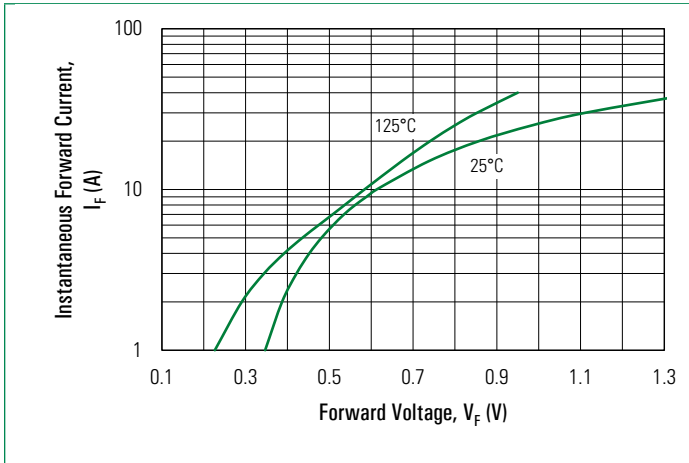

Fig. 2. Typical Reverse Characteristics

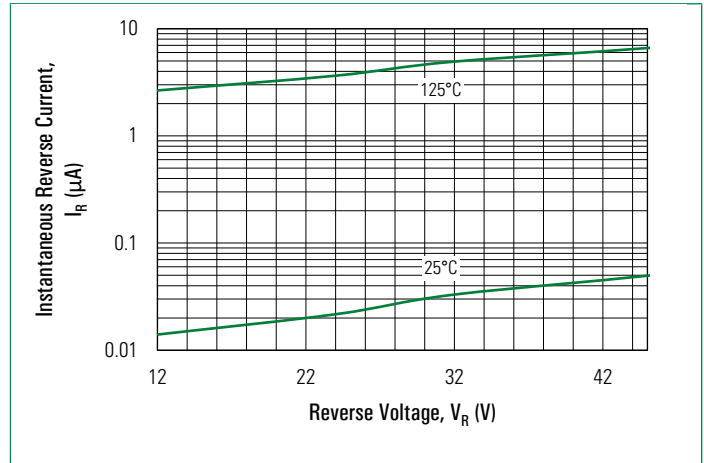
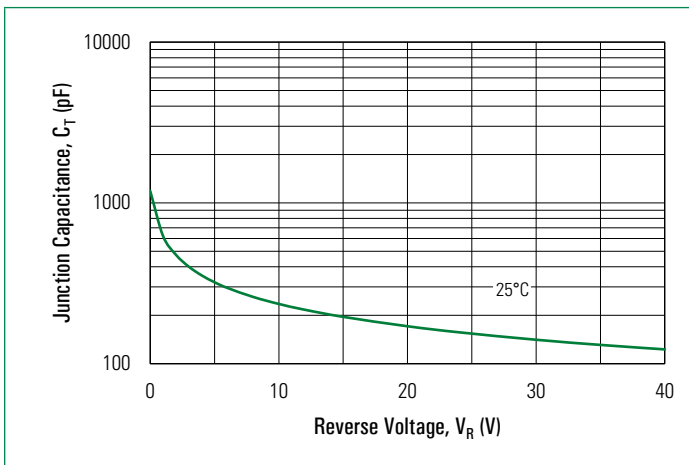
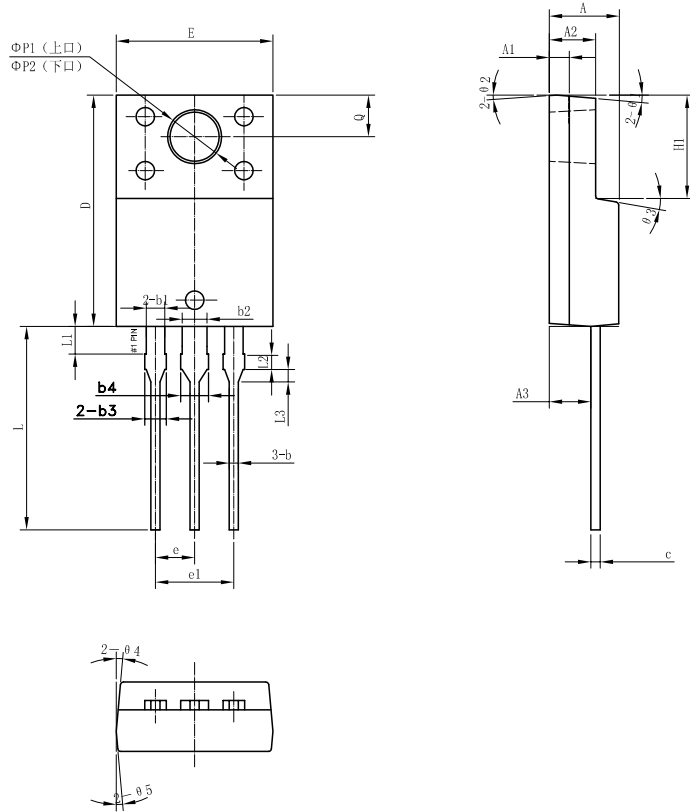

Fig. 3. Typical Junction Capacitance



Part Outline Drawing (TO-220-3L ABFP)



Symbol	Inches			Millimeters		
	Min.	Typical	Max.	Min.	Typical	Max
A	0.169	0.177	0.185	4.30	4.50	4.70
A1	0.043	0.051	0.059	1.10	1.30	1.50
A2	0.110	0.118	0.126	2.80	3.00	3.20
A3	0.098	0.106	0.114	2.50	2.70	2.90
b	0.020	0.024	0.03	0.50	0.60	0.75
b1	0.043	0.047	0.053	1.10	1.20	1.35
b2	0.059	0.063	0.069	1.50	1.60	1.75
b3	0.047	0.051	0.057	1.20	1.30	1.45
b4	0.063	0.067	0.073	1.60	1.70	1.85
c	0.020	0.024	0.030	0.50	0.60	0.75
D	0.583	0.591	0.598	14.80	15.00	15.20
E	0.392	0.400	0.408	9.96	10.16	10.36
e	-	0.100	-	-	2.55	-
e1	-	0.201	-	-	5.10	-
H1	0.256	0.264	0.272	6.50	6.70	6.90
L	0.500	0.520	0.539	12.70	13.20	13.70
L1	0.063	0.071	0.079	1.60	1.80	2.00
L2	0.031	0.039	0.047	0.80	1.00	1.20
L3	0.024	0.031	0.039	0.60	0.80	1.00
ØP1	0.130	0.138	0.146	3.30	3.50	3.70
ØP2	0.118	0.126	0.133	2.99	3.19	3.39
Q	0.098	0.106	0.114	2.50	2.70	2.90

Part Numbering and Marking

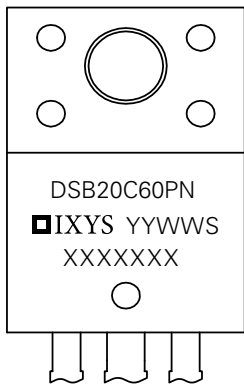

- D = Diode
- S = Schottky Diode
- B = Ultra Low V_F
- 20 = Current Rating (20 A)
- C = Common Cathode
- 60 = Voltage Rating (60 V)
- PN = Package Code
- YY = Year
- WW = Work Week
- S = Plant Location Code
- XXXXXXXX = Lot Number

Ordering Information

Part Number	Marking	Packing Mode	Quantity
DSB20C60PN	DSB20C60PN	Tube	50 pcs/tube

Packing Specifications

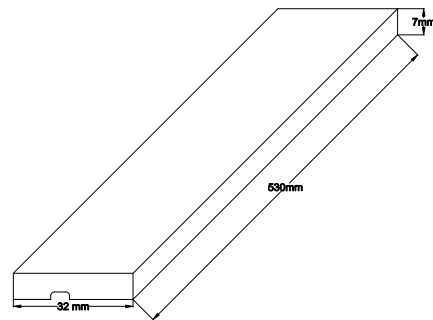

Disclaimer Notice

Information furnished is believed to be accurate and reliable. However, users should independently evaluate the suitability of and test each product selected for their own applications. Littelfuse products are not designed for, and may not be used in, all applications. Read complete Disclaimer Notice at <http://www.littelfuse.com/disclaimer-electronics>.