



| Parameter | Rating | Units |
|-----------------------|--------|------------|
| Blocking Voltage | 800 | V_P |
| Load Current | 100 | mA_{rms} |
| | 85 | mA_{DC} |
| On-Resistance (max) | 50 | Ω |
| Input Control Current | 2 | mA |

Features

- Guaranteed Specifications at 105°C
- -40°C to +105°C Operational Temperature Range
- 5mA Input Control Current Over Operating Temperature Range
- 800V_P Blocking Voltage
- 6.8mm Pad-to-Pad Separation of Output Pins
- 5000V_{rms} Input/Output Isolation
- Small Surface Mount Package
- No EMI/RFI Generation
- Flammability Rating UL 94 V-0

Applications

- Industrial Controls
- Instrumentation
- Multiplexers
- Data Acquisition
- Electronic Switching
- I/O Subsystems
- Meters (Watt-Hour, Water, Gas)
- Medical Equipment—Patient/Equipment Isolation

Description

IXYS Integrated Circuits' PLA172P is a single-pole, normally-open (1-Form-A) Solid State Relay, rated for operation up to 105°C, that uses optically coupled MOSFET technology to provide an enhanced input to output isolation of 5000V_{rms}.

The unique device pinout provides more than 6.8mm of pad-to-pad separation between the high voltage output pins.

Control of the optically coupled output is by the input infrared LED. The PLA172P is designed to replace electromechanical relays, and provides bounce-free switching in a compact, surface-mount package.

Approvals

- UL Recognized Component: File # E76270
- TUV EN 62368-1: Certificate # B 082667 0008

Ordering Information

| Part # | Description |
|-----------|--|
| PLA172P | 6-Pin (8-Pin Body) Flatpack (50/Tube) |
| PLA172PTR | 6-Pin (8-Pin Body) Flatpack, Tape & Reel (1000/Reel) |

Pin Configuration

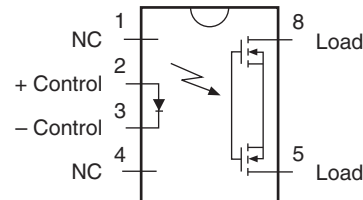

Switching Characteristics of Normally-Open Devices

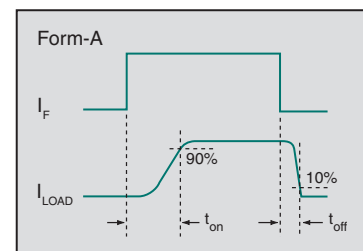

Absolute Maximum Ratings (@ 25°C Unless otherwise noted)

| Parameter | Ratings | Units |
|---|-------------|------------------|
| Blocking Voltage (-40°C to +105°C) | 800 | V _P |
| Reverse Input Voltage | 5 | V |
| Input Control Current | 50 | mA |
| Peak (10ms) | 1 | A |
| Input Power Dissipation ¹ | 150 | mW |
| Output Power Dissipation | | |
| AC Load Current ² | 890 | mW |
| DC Load Current ³ | 667 | |
| Isolation Voltage, Input to Output (60 Seconds) | 5000 | V _{rms} |
| Operational Temperature, Ambient | -40 to +105 | °C |
| Storage Temperature | -40 to +125 | °C |

¹ Derate linearly 1.33 mW / °C

² Derate output power linearly 8.9 mW / °C

³ Derate output power linearly 6.67 mW / °C

Absolute Maximum Ratings are stress ratings. Stresses in excess of these ratings can cause permanent damage to the device. Functional operation of the device at conditions beyond those indicated in the operational sections of this data sheet is not implied.

Typical values are characteristic of the device at the specified temperatures and are the result of engineering evaluations. They are provided for information purposes only and are not part of the manufacturing testing requirements.

Electrical Characteristics

| Parameter | Conditions | Symbol | Min | Typ | Max | Units |
|--|--|-------------------|-----------------------------|------------------|-----|-------------------|
| Output Characteristics @ 25°C | | | | | | |
| Blocking Voltage | I _L =1μA | V _{DRM} | 800 | - | - | V _P |
| Load Current | | | | | | |
| Continuous, AC ¹ | I _F =2mA | I _L | - | - | 100 | mA _{rms} |
| Continuous, DC ² | | | - | - | 85 | mA _{DC} |
| Peak | | | I _F =2mA, t=10ms | I _{LPK} | - | - |
| On-Resistance ³ | I _F =2mA, I _L =100mA | R _{ON} | - | 37 | 50 | Ω |
| | I _F =2mA, I _L =1mA | | - | 57 | 85 | |
| Off-State Leakage Current | V _L =800V | I _{LEAK} | - | - | 1 | μA |
| Switching Speeds | | | | | | |
| Turn-On | I _F =5mA, I _L =100mA | t _{on} | - | 1.2 | 5 | ms |
| Turn-Off | | t _{off} | - | 0.5 | 5 | |
| Output Capacitance | I _F =0mA, V _L =20V, f=1MHz | C _{OUT} | - | 10 | - | pF |
| Output Characteristics @ 105°C | | | | | | |
| On-Resistance ³ | I _F =5mA, I _L =30mA | R _{ON} | - | 70 | 110 | Ω |
| | I _F =5mA, I _L =1mA | | - | 110 | 140 | |
| Off-State Leakage Current | V _L =800V | I _{LEAK} | - | - | 5 | μA |
| Switching Speeds | | | | | | |
| Turn-On | I _F =5mA, I _L =30mA | t _{on} | - | - | 10 | ms |
| Turn-Off | | t _{off} | - | - | 10 | |
| Input Characteristics @ 25°C | | | | | | |
| Input Control Current to Activate ⁴ | I _L =100mA | I _F | - | 0.35 | 2 | mA |
| Input Control Current to Deactivate | - | I _F | 0.05 | - | - | mA |
| Input Voltage Drop | I _F =5mA | V _F | 0.9 | 1.36 | 1.5 | V |
| Reverse Input Current | V _R =5V | I _R | - | - | 10 | μA |
| Input Characteristics @ 105°C | | | | | | |
| Input Control Current to Activate | I _L =30mA | I _F | - | - | 5 | mA |
| Common Characteristics @ 25°C | | | | | | |
| Input to Output Capacitance | V _{IO} =0V, f=1MHz | C _{IO} | - | 1 | - | pF |

¹ Load derates linearly from 100mA @ 25°C to 44mA @ 105°C (0.7mA/°C).

² Load derates linearly from 85mA @ 25°C to 38mA @ 105°C (0.59mA/°C).

³ Measurement taken within 1 second of on-time.

⁴ For applications requiring high temperature operation (greater than 60°C) a minimum LED drive current of 5mA is recommended.

PERFORMANCE DATA*

Typical LED Forward Voltage Drop
(N=50, $I_F=5\text{mA}$)

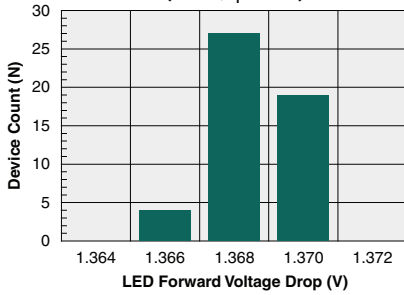

Typical I_F for Switch Operation
(N=50, $I_L=100\text{mA}$)

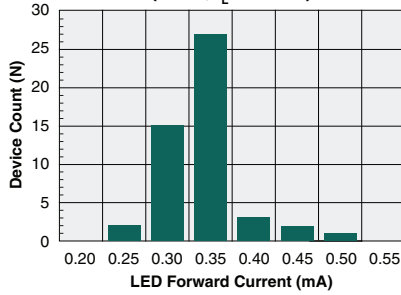

Typical I_F for Switch Dropout
(N=50, $I_L=100\text{mA}$)

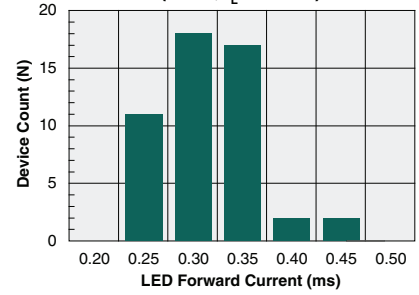

Typical On-Resistance
(N=50, $I_F=5\text{mA}$, $I_L=1\text{mA}$)

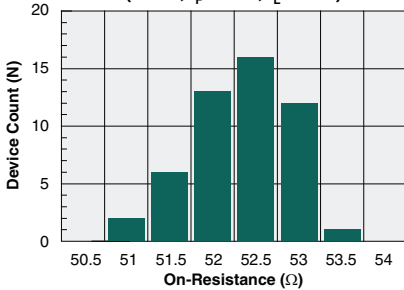

Typical Turn-On Time
(N=50, $I_F=5\text{mA}$, $I_L=100\text{mA}$)

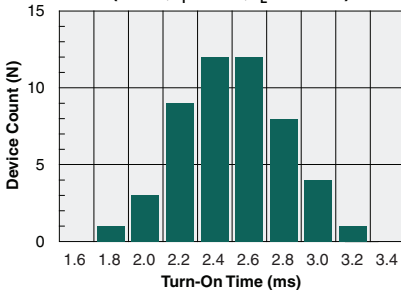

Typical Turn-Off Time
(N=50, $I_F=5\text{mA}$, $I_L=100\text{mA}$)

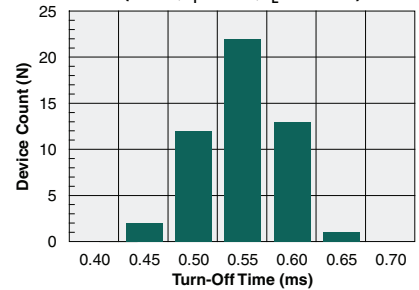

Typical On-Resistance
(N=50, $I_F=5\text{mA}$, $I_L=100\text{mA}$)

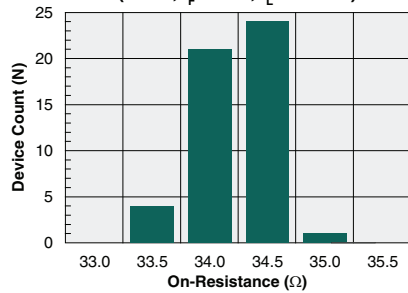

Typical Blocking Voltage Distribution
(N=50)

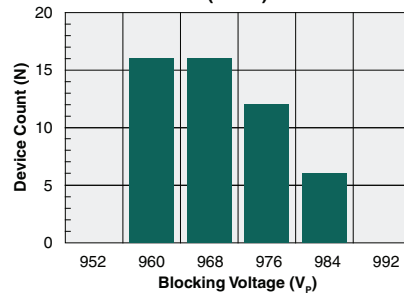

Typical LED Forward Voltage Drop vs. Temperature

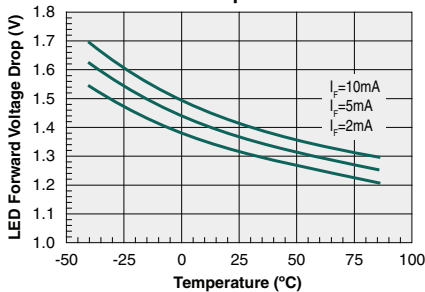

Turn-On Time vs. LED Forward Current
($I_L=100\text{mA}$)

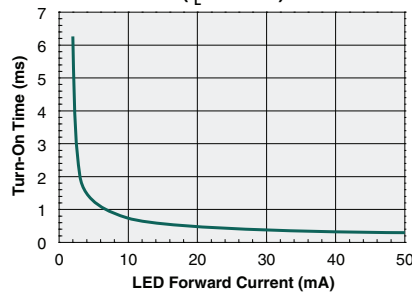

Turn-Off Time vs. LED Forward Current
($I_L=100\text{mA}$)

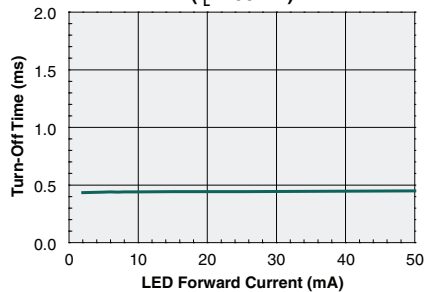

*Unless otherwise noted, data presented in these graphs is typical of device operation at 25°C.

PERFORMANCE DATA*

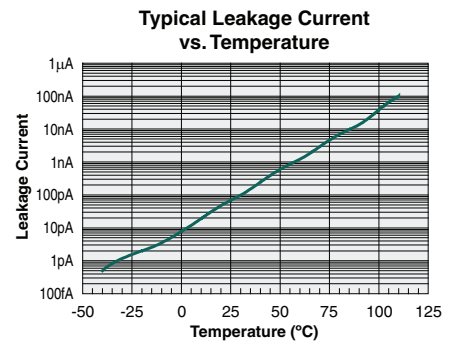
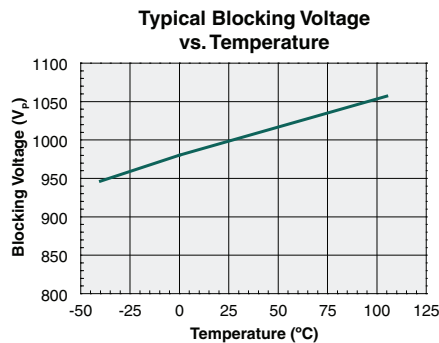
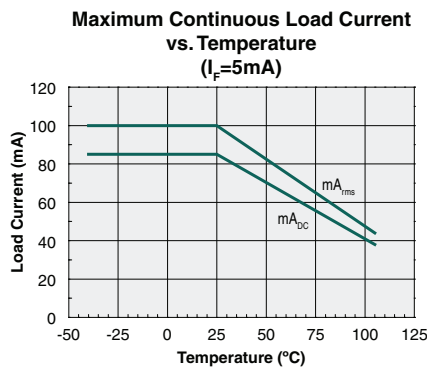
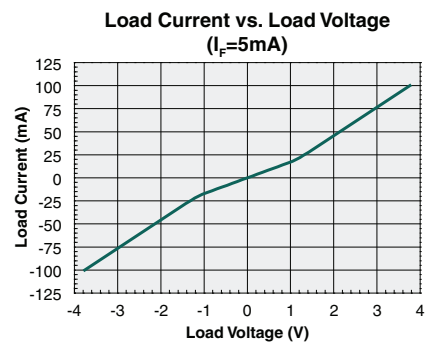
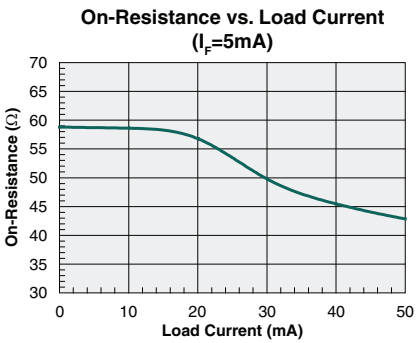
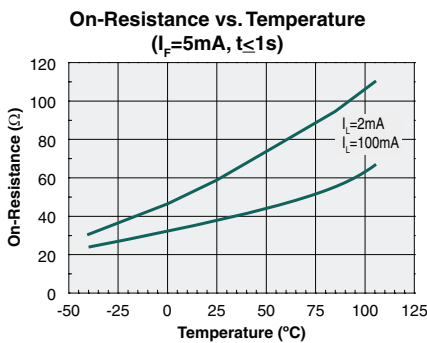
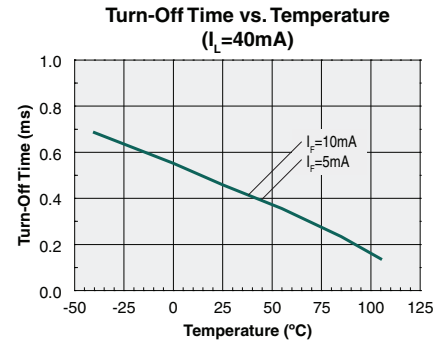
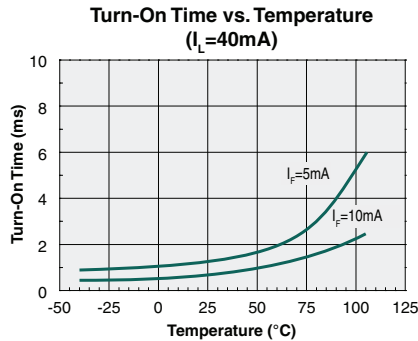
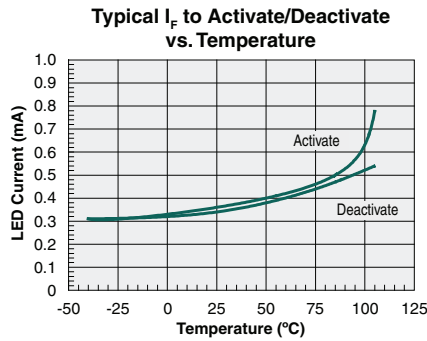

*Unless otherwise noted, data presented in these graphs is typical of device operation at 25°C.

Manufacturing Information

Moisture Sensitivity



All plastic encapsulated semiconductor packages are susceptible to moisture ingress. IXYS Integrated Circuits classifies its plastic encapsulated devices for moisture sensitivity according to the latest version of the joint industry standard, **IPC/JEDEC J-STD-020**, in force at the time of product evaluation. We test all of our products to the maximum conditions set forth in the standard, and guarantee proper operation of our devices when handled according to the limitations and information in that standard as well as to any limitations set forth in the information or standards referenced below.

Failure to adhere to the warnings or limitations as established by the listed specifications could result in reduced product performance, reduction of operable life, and/or reduction of overall reliability.

This product carries a **Moisture Sensitivity Level (MSL)** classification as shown below, and should be handled according to the requirements of the latest version of the joint industry standard **IPC/JEDEC J-STD-033**.

| Device | Moisture Sensitivity Level (MSL) Classification |
|---------|---|
| PLA172P | MSL 1 |

ESD Sensitivity



This product is ESD Sensitive, and should be handled according to the industry standard **JESD-625**.

Soldering Profile

Provided in the table below is the **IPC/JEDEC J-STD-020** Classification Temperature (T_C) and the maximum total dwell time (t_p) in all reflow processes that the body temperature of these surface mount devices may be ($T_C - 5$)°C or greater. The device's body temperature must not exceed the Classification Temperature at any time during reflow soldering processes.

| Device | Classification Temperature (T_C) | Dwell Time (t_p) | Max Reflow Cycles |
|---------|--------------------------------------|----------------------|-------------------|
| PLA172P | 250°C | 30 seconds | 3 |

Board Wash

IXYS Integrated Circuits recommends the use of no-clean flux formulations. Board washing to reduce or remove flux residue following the solder reflow process is acceptable provided proper precautions are taken to prevent damage to the device. These precautions include but are not limited to: using a low pressure wash and providing a follow up bake cycle sufficient to remove any moisture trapped within the device due to the washing process. Due to the variability of the wash parameters used to clean the board, determination of the bake temperature and duration necessary to remove the moisture trapped within the package is the responsibility of the user (assembler). Cleaning or drying methods that employ ultrasonic energy may damage the device and should not be used. Additionally, the device must not be exposed to halide flux or solvents.



Mechanical Dimensions

PLA172P Package

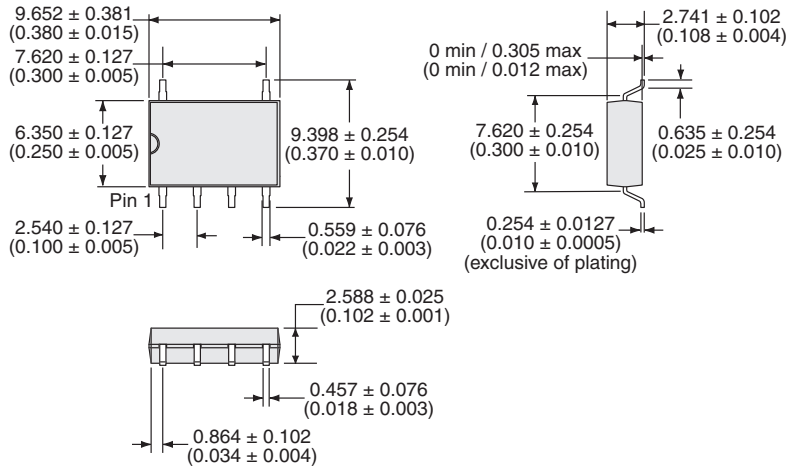

PCB Land Pattern

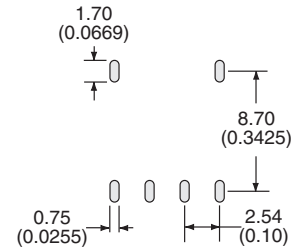

Dimensions
mm
(inches)

PLA172PTR Tape & Reel

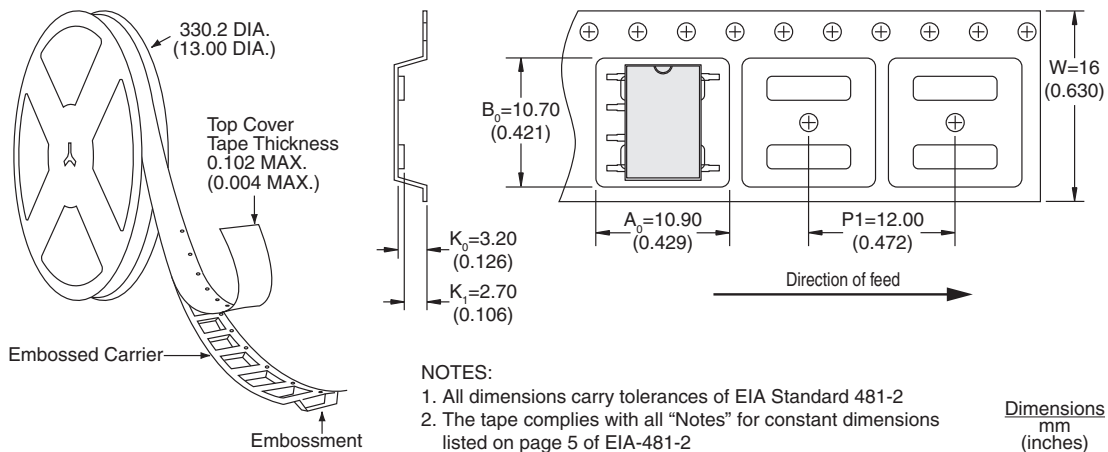

Dimensions
mm
(inches)

For additional information please visit our website at: <https://www.ixysic.com>