

**PGR-8800**  
**ARC-FLASH RELAY**  
**REVISION 3-D-052923**

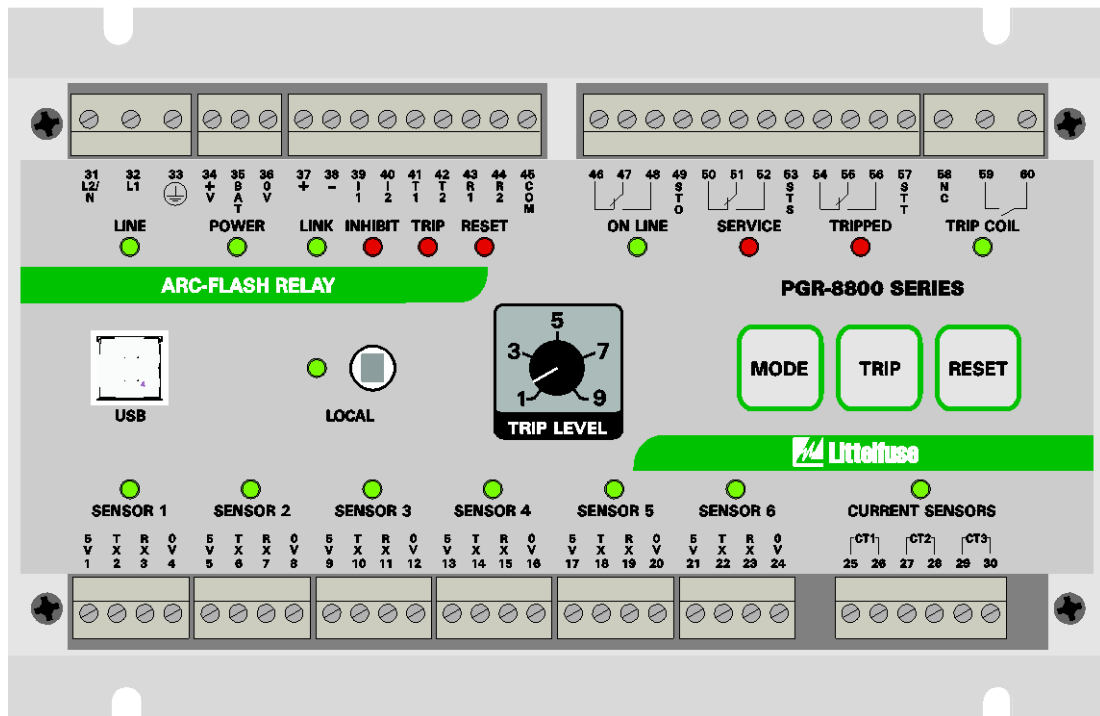

Document Number: PM-1400-EN

This page intentionally left blank.

**TABLE OF CONTENTS**

1	INTRODUCTION.....	7
1.1	Current-Supervised Arc-Flash Protection.....	7
1.2	Definite-Time Overcurrent Protection.....	7
1.3	Fail-Safe Operation.....	7
1.4	Fast-Fault Location.....	7
1.5	USB Interface.....	8
1.6	Scalable System.....	8
1.7	Upstream Circuit Breaker Tripping.....	8
2	INSTALLATION.....	9
3	POWER SUPPLY.....	12
3.1	AC Supply.....	12
3.2	DC Supply.....	12
3.3	Low-Voltage DC Supply.....	13
3.4	External 24-V Battery Backup.....	13
4	OPTICAL SENSORS.....	14
4.1	PGA-LS10 Photoelectric Point Sensor with Sensor Check.....	15
4.1.1	PGA-LS10 Connection.....	16
4.1.2	PGA-LS10 Installation.....	17
4.2	PGA-LS20 and PGA-LS30 Fiber-Optic Sensor with Sensor Check.....	18
4.2.1	Fiber Connection.....	18
4.2.2	Receiver Wiring Connections.....	18
4.2.3	Transmitter Wiring Connections.....	18
4.2.4	PGA-LS20 and PGA-LS30 Connection.....	19
5	SENSOR PLACEMENT.....	20
5.1	General Guidelines.....	20
5.2	Switchgear Protection.....	20
5.3	Transformer Protection.....	20
6	CURRENT SENSORS.....	21
6.1	Current Inhibit Mode.....	21
6.2	Overcurrent Protection.....	21
6.3	Current Sensor Characteristics.....	22
7	DIGITAL INPUTS.....	23
7.1	Inhibit.....	23
7.2	Trip.....	23
7.3	Reset.....	23
7.4	Circuit Check.....	23
8	OUTPUTS.....	24
8.1	Online.....	24
8.2	Service.....	25
8.3	Tripped.....	25
8.4	Trip Coil.....	27

9	LED INDICATION.....	29
10	PGR-8800 BUTTONS.....	29
10.1	Mode.....	32
10.2	Trip.....	32
10.3	Reset.....	32
10.4	Mode + Reset.....	32
10.5	Mode + Trip.....	32
11	LINK.....	33
11.1	Configuration.....	33
11.2	Button Function.....	33
11.3	Modbus Communication.....	34
12	USB INTERFACE.....	35
12.1	Connecting to a PC.....	35
12.2	Configuration Software.....	36
12.2.1	Configuration Software Tabs.....	36
12.2.2	Configuration Software Buttons.....	37
12.2.3	Default Configuration.....	37
12.2.4	General Settings.....	38
12.2.5	Optical-Sensor Settings.....	38
12.2.6	Current-Sensor Settings.....	41
12.2.7	Digital-Input Settings.....	43
12.2.8	Output Settings.....	44
12.2.8.1	Online Output.....	44
12.2.8.2	Service Output.....	45
12.2.8.3	Tripped Output.....	47
12.2.8.4	Trip Coil Output.....	49
12.2.9	Communications Settings.....	52
12.2.10	Advanced Settings.....	55
12.2.11	About Tab.....	56
12.3	Data Log Drive.....	56
12.4	Firmware Upgrade.....	58
13	COMMISSIONING.....	59
13.1	Configuration of Installed Sensors.....	59
13.2	Testing the Sensors.....	59
13.3	Testing the Trip Coil.....	60
13.4	Full Operation Test (Online).....	60
13.5	Light Sensitivity Adjustment.....	61
13.6	Fiber-Optic Sensor Adjustment.....	61
13.6.1	Sensor Adjustment for a Fiber Length other than 60 cm (24").....	61
13.6.2	Sensor Adjustment in Small Compartments.....	62
14	SPECIFICATIONS.....	63
14.1	PGR-8800.....	63
14.2	Sensors.....	67

15 ORDERING INFORMATION.....	68
16 WARRANTY .....	68
APPENDIX A PGR-8800 MODBUS RTU PROTOCOL .....	69
A.1 Protocol .....	69
A.1.1 Configuration Setup .....	69
A.2 Message Synchronization .....	69
A.3 Error Checking .....	69
A.4 Function Codes Supported.....	70
A.4.1 Read Input/Holding Registers (Code 04/03) .....	70
A.4.2 Write to Register.....	70
A.4.2.1 Write Single Register (Code 6) .....	70
A.4.2.2 Write Multiple Registers (Code 16) .....	71
A.4.3 Exception Responses.....	71
A.5 PGR-8800 Database .....	71
A.6 Specifications .....	71
APPENDIX B MODBUS COMMUNICATIONS DATABASE TABLE.....	72
APPENDIX C COORDINATED TRIPPING OF UPSTREAM BREAKERS .....	78
C.1 System Overview .....	78
C.1.1 Circuit Breaker Feedback Detection .....	78
C.1.2 Current Sensor Detection .....	78
C.1.3 Total Clearing Time .....	78
C.1.3.1 Arc Detection Delay.....	78
C.1.3.2 Circuit Breaker Operating Time .....	79
C.1.3.3 Output Delay .....	79
C.1.3.4 Total Clearing Time Examples.....	79
C.1.4 Relay Output .....	79
C.1.5 Link Output.....	79
C.1.6 PGA-1100 Diode Logic Unit .....	80
C.2 Application and Configuration .....	80
C.2.1 Single PGR-8800 Configuration .....	80
C.2.2 Dual PGR-8800 Configuration using Link Interface.....	84
C.2.3 Single PGR-8800 Configuration with Current Sensor Input.....	85
C.2.4 Dual PGR-8800 Configuration using Link Interface and Current Sensor Input.....	90
C.2.5 Configuration of Multiple Inputs and Outputs.....	93
C.2.6 Tripping Common Upstream Circuit Breaker from Several Zones using PGA-1100.....	94
APPENDIX D SYSTEM PARAMETERS AND SETUP RECORD.....	95
APPENDIX E PGR-8800 REVISION HISTORY .....	100

**LIST OF FIGURES**

1	PGR-8800 Outline and Mounting Details .....	9
2	PGR-8800 Typical Wiring Diagram .....	10
3	PGR-8800 24-Vdc Source Typical Wiring Diagram.....	11
4	Local Sensor Detection Zone for a 3 kA Fault.....	14
5	PGA-LS10 Detection Range for a 3 kA Fault.....	15
6	PGA-LS10 Connection Diagram .....	16
7	PGA-LS10 Mounting Detail .....	17
8	PGA-LS20 and PGA-LS30 Connection Diagram .....	19
9	LED Flash Patterns.....	29
C.1	Single PGR-8800 Application.....	81
C.2	Dual PGR-8800 Configuration using Link Interface.....	84
C.3	Single PGR-8800 Configuration with Current Sensor Input.....	86
C.4	Dual PGR-8800 Configuration using Link Interface and Current Sensor Input .....	90
C.5	Tripping Common Upstream Circuit Breaker from Several Zones using PGA-1100 .....	94

**LIST OF TABLES**

A.1	Read Registers (Code 04/03) .....	70
A.2	Write Single Register (Code 6) .....	70
A.3	Write Multiple Registers (Code 16) .....	71
C.1	Circuit Breaker Operating Times.....	79

## 1 INTRODUCTION

The PGR-8800 Arc-Flash Relay is a high-speed, arc-detection device for electrical power-distribution systems. The PGR-8800 has one local sensor and supports both point and fiber-optic sensor technologies for optical arc detection. There are inputs for six optical sensors and three current sensors.

On the occurrence of an arc fault, the PGR-8800 detects the fault and pulses the trip contact in less than one millisecond. The tripping pulse is typically used to trip the circuit breaker(s) supplying the circuit. The total arcing time is effectively reduced to the mechanical opening time of the circuit breaker; typically between 30 and 75 milliseconds. The trip contact is a solid-state switch (IGBT), which provides fast reaction and sufficient drive capability for circuit-breaker trip circuits.

Using optical sensors rather than relying strictly on current measurement allows a much faster detection time than overcurrent relays or a circuit breaker alone can typically provide. This will lower the incident energy of an arc flash and increase worker safety, reduce fault damage, and improve uptime. Since the incident energy is decreased, the level of personal protective equipment (PPE) required may also be lowered, subject to an arc-flash study modeling the system parameters.

The MODBUS RTU protocol is implemented in the PGR-8800. This will provide status information for sensors, analog inputs, digital inputs, digital outputs, and numerous event and error flags. It also provides the ability to remotely reset the PGR-8800. See Section 11.3 and Appendices A and B.

The PGR-8800 can be used on any electrical system with any voltage (ac or dc) and can be powered from either an ac or dc supply, or both. If it is powered from line supply, it can charge a backup battery to power the PGR-8800 when the line supply is lost.

### **1.1 Current-Supervised Arc-Flash Protection**

The PGR-8800 has three phase-current inputs which can be used to prevent optical trips when the measured current is below a user-specified level. This makes it possible to avoid nuisance tripping from external light sources such as lightning or welding arcs.

### **1.2 Definite-Time Overcurrent Protection**

Using the phase-current inputs, the PGR-8800 can be configured to trip on overcurrent, with a minimum reaction time of one millisecond. There are two user-adjustable levels of overcurrent protection with independent trip times to coordinate with other protective devices. This provides protection from long-lasting overload conditions and fast reaction to overcurrent even when no arc is detected.

### **1.3 Fail-Safe Operation**

The PGR-8800 continuously monitors its internal circuitry as well as the connected optical sensors. Any system faults, including a sensor-cable fault, are indicated by a flashing LED and can be logged. A redundant trip circuit ensures that the PGR-8800 will trip on an arc flash even if a primary trip-circuit component fails. The solid-state design of the redundant trip circuit also provides a significantly faster response to an arc on power-up (for example, after maintenance during a shutdown) than is possible with microprocessor-only relays.

### **1.4 Fast-Fault Location**

The optical sensors used with the PGR-8800 include LED indication of health and, if it has detected an arc flash, of fault location. The PGR-8800 also has one LED per optical sensor to indicate which sensor(s) have caused a trip.

### **1.5 USB Interface**

A USB interface on the front of the PGR-8800 provides easy PC access to configuration settings and access to an event log which provides detailed diagnostic information about measurements before and after a trip. No PC driver or software installation is required.

### **1.6 Scalable System**

Up to four PGR-8800 modules can be connected into a single system, allowing a total of 24 optical sensors per system. Each PGR-8800 can be programmed to have up to 4 independent trip zones, providing flexibility to fit various tripping schemes on larger systems.

### **1.7 Upstream Circuit Breaker Tripping**

The PGR-8800 can be configured to trip an upstream circuit breaker as a backup to local circuit-breaker failure. Circuit-breaker failure can be detected with a discrete input (such as a local circuit breaker feedback signal), current measurement, or the Link function. See Appendix C for more information.



## 2 INSTALLATION

The PGR-8800 can be surface mounted using four 5-mm (10-32) screws, or it can be DIN-rail mounted using the optional mounting brackets (PGA-0031).

Ensure there is enough clearance around the module to allow the plug-in terminals to be removed and inserted.

Do not install modules which have been damaged in transport.

See the PGR-8800 Arc-Flash Relay Application Guide for additional installation information.

**NOTE:** The PGR-8800 includes an internal non-rechargeable battery that powers the real-time clock. Please consult local regulations regarding the use of batteries in electrical equipment. The battery is not designed for user service or removal; please contact Littelfuse with any questions regarding battery removal.

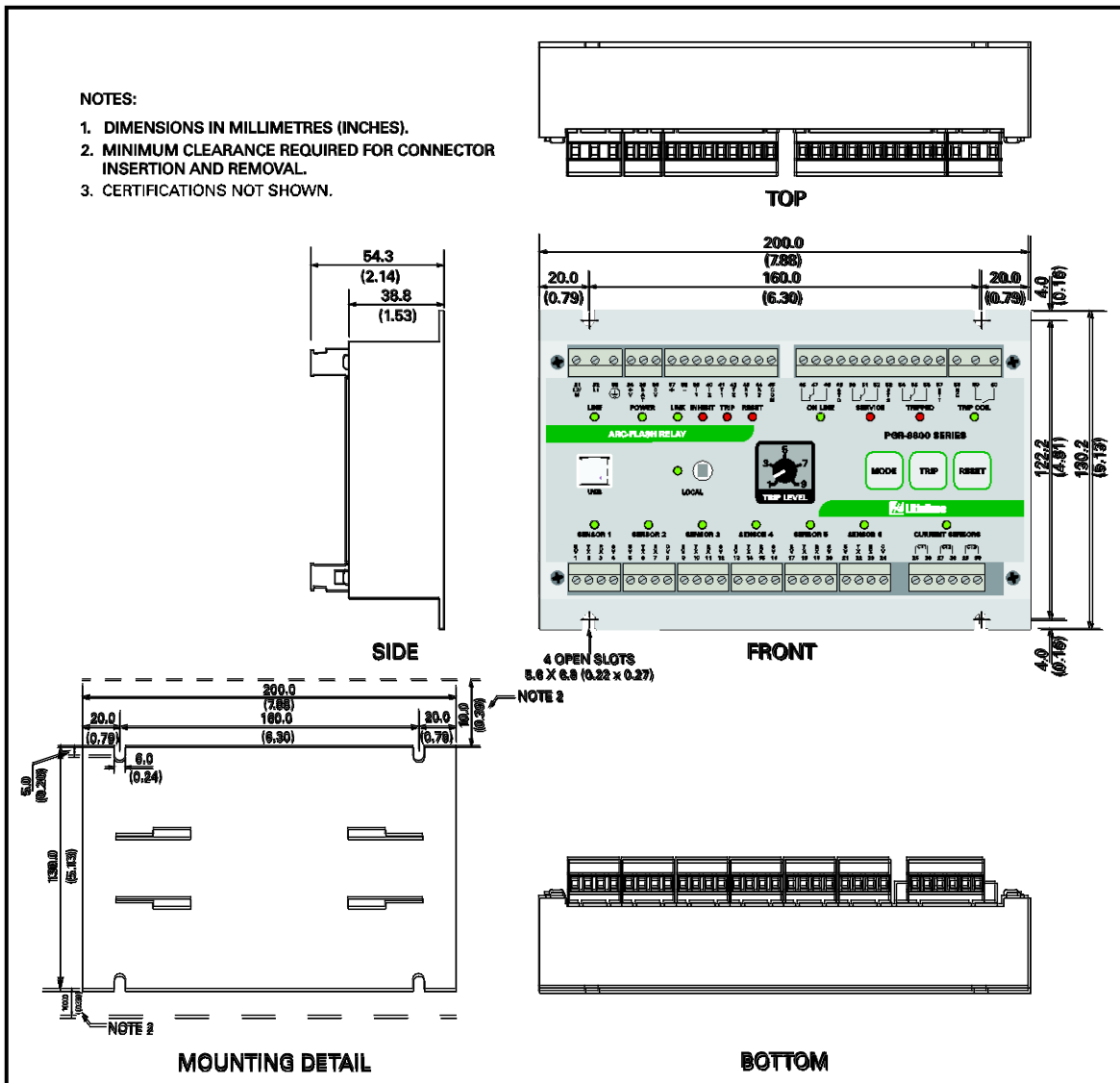

FIGURE 1. PGR-8800 Outline and Mounting Details.

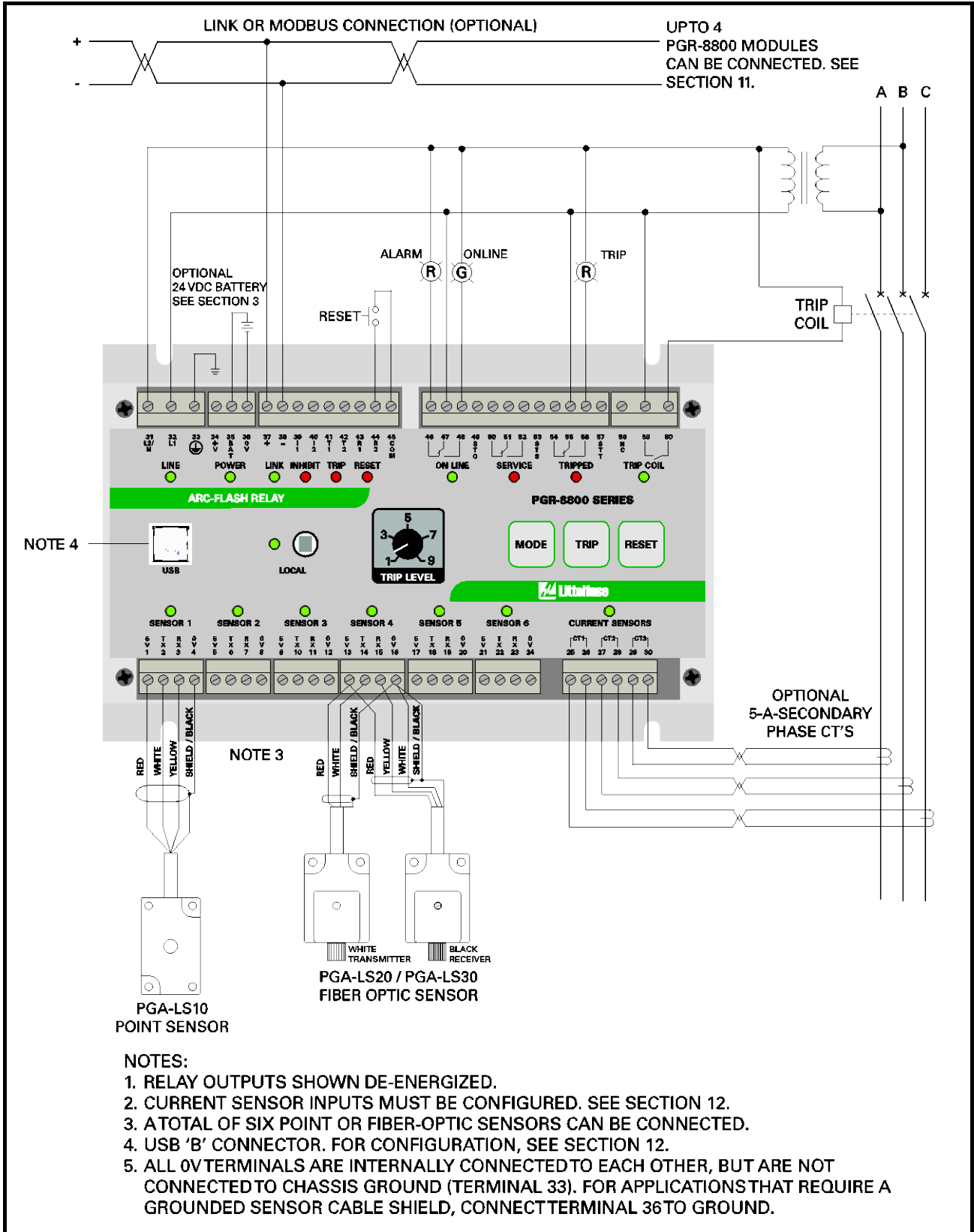

FIGURE 2. PGR-8800 Typical Wiring Diagram.



### 3 POWER SUPPLY

The PGR-8800 Arc-Flash Relay can be powered from an ac or dc supply, or both. However, only one source can be connected to terminals 31 and 32.

#### 3.1 AC Supply

Connect an ac supply to terminals 31 and 32. The supply voltage must be 100 to 240 Vac.

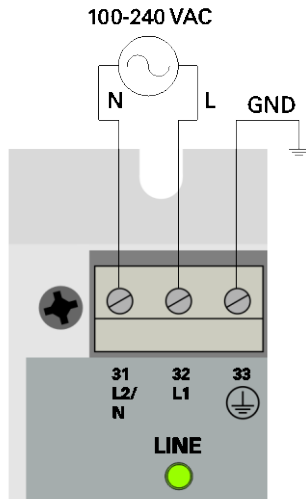

#### 3.2 DC Supply

Connect a dc supply to terminals 31 and 32, ensuring correct polarity. The supply voltage must be 110 to 250 Vdc.

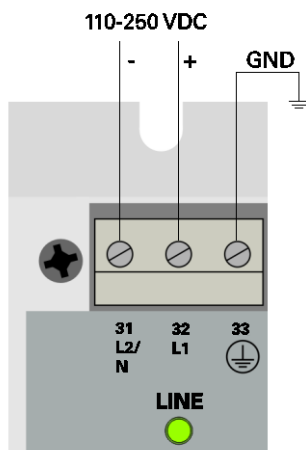

### 3.3 Low-Voltage DC Supply

Connect a dc supply to terminals 34 and 36, ensuring correct polarity. The supply voltage must be 14 to 48 Vdc. This input will not charge the backup battery.

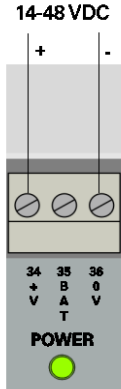

### 3.4 External 24-V Battery Backup

Connect a 24-Vdc battery to terminals 35 and 36, ensuring correct polarity. The PGR-8800 will only charge the battery when there is rated voltage on power-supply terminals 31 and 32 (ac or dc). The PGR-8800 supplies a constant-current, constant-voltage (CCCV) of 27 V with no load and maximum available current of 200 mA. A sealed lead-acid battery with a capacity between 2 and 15 Ah, such as a pair of Panasonic VRLA LC-R122R2P, should be used and exchanged regularly according to the manufacturer's recommendations.

If the PGR-8800 is supplied by the backup battery and the battery voltage drops below 20 V, the PGR-8800 will shut down to protect the battery.

Do not combine external battery backup and the low-voltage DC supply. The DC supply will not charge the battery.

**NOTE:** Arc monitoring is disabled when the PGR-8800 is powered down.

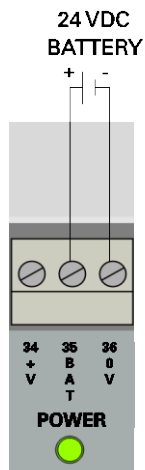

#### 4 OPTICAL SENSORS

The PGR-8800 has one local sensor and six inputs for external optical sensors. The local sensor is primarily used for commissioning and can also be enabled for arc-flash protection. Its light-detection zone is illustrated in the diagram below.

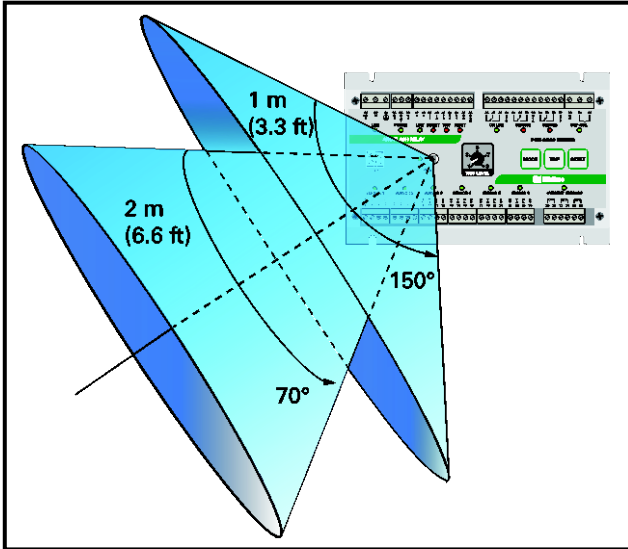

FIGURE 4. Local Sensor Detection Zone for a 3 kA Fault.

Two external sensor types are supported:

- PGA-LS10 Photoelectric Point Sensor with sensor check
- PGA-LS20 and PGA-LS30 Fiber-Optic Sensors with sensor check

The sensors can be used together, in any combination.

Both sensor types have LED indication of sensor health and fault location. A sensor-check circuit tests the sensor to verify that the sensor assembly is functioning correctly. A healthy sensor will indicate two fast flashes of its internal red LED every few seconds. A sensor that has detected an arc will slowly flash red.

The sensors connect to the PGR-8800 with shielded three-wire 20 AWG (0.5 mm<sup>2</sup>) electrical cable. Each sensor includes 10 m (33 ft) of cable which can be shortened or extended up to 50 m (164 ft). These cables should be considered to be at ground potential when determining electrical clearances in the cabinet.

Any connected optical sensor with circuit check will be automatically detected and cause the PGR-8800 to report an error if it is subsequently disconnected.

##### PGA-LS10



##### PGA-LS20 / PGA-LS30



**NOTE:** Inserting and removing sensor cables can cause a trip depending on which terminals make contact first. Always place the unit in service mode before connecting and disconnecting sensors.

#### 4.1 PGA-LS10 Photoelectric Point Sensor with Sensor Check

This sensor has a detection area of a 2-m (7 ft) half-sphere for arcs of 3 kA or more.

A built-in LED enables the PGR-8800 to verify the function of the light sensor, wiring, and electronics. If the sensor does not detect the sensor-check LED, a sensor-fail alarm will occur -- the ONLINE output will change state and the ONLINE LED will begin to short flash. See Section 9.

The sensor includes 10 m (33 ft) of shielded three-wire electrical cable which can easily be shortened or extended to a maximum of 50 m (164 ft). The following AWM styles (or equivalent) can be used:

- Style 2464, 20 AWG, 80 C rated, 300V, 3-conductor with shield
- Style 1316, 20 AWG, 105 C rated, 600V, 3-conductor with shield
- Style 21819, 20 AWG, 105 C rated, 600V, 3-conductor with shield

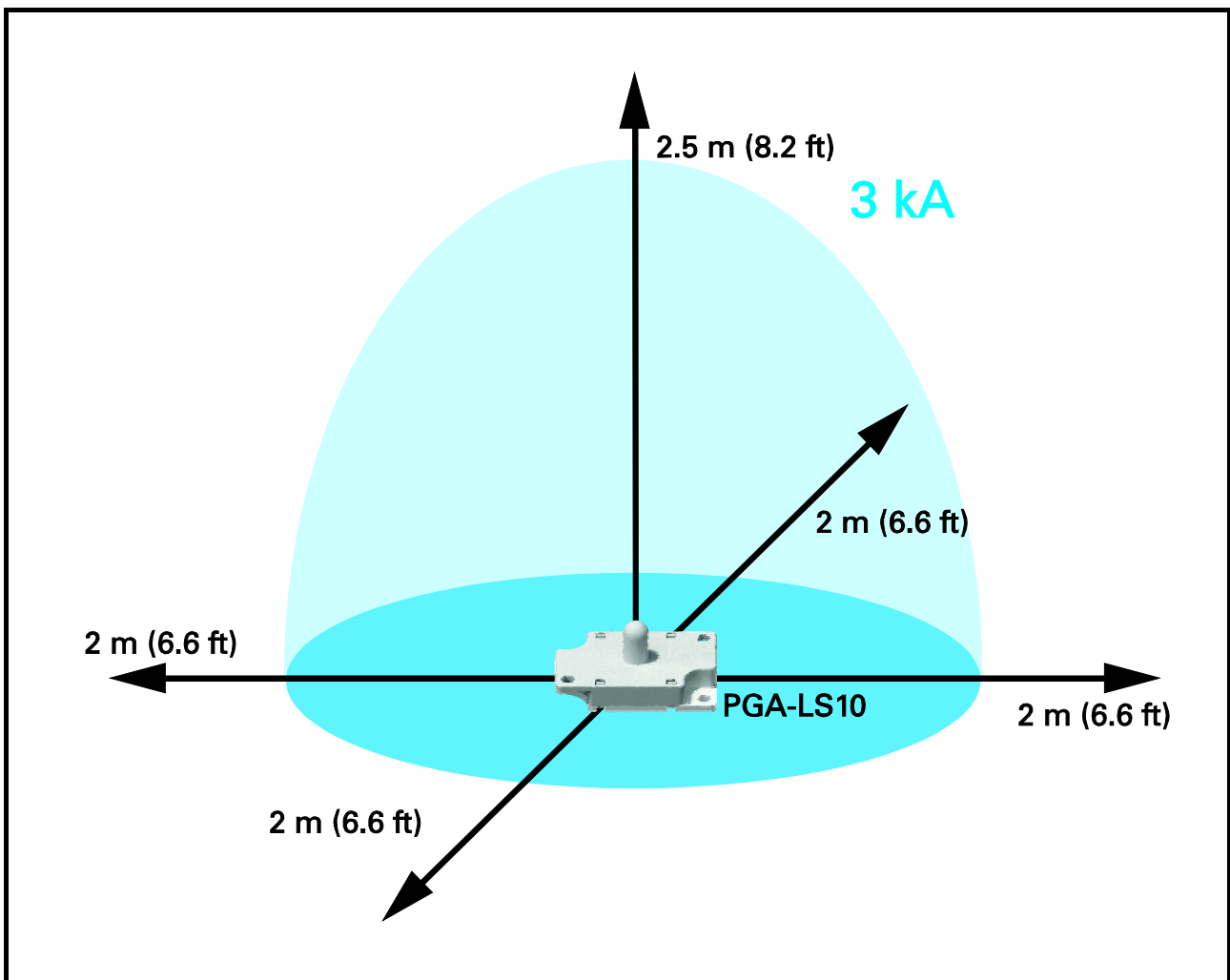

FIGURE 5. PGA-LS10 Detection Range for a 3 kA Fault.

**4.1.1 PGA-LS10 Connection**

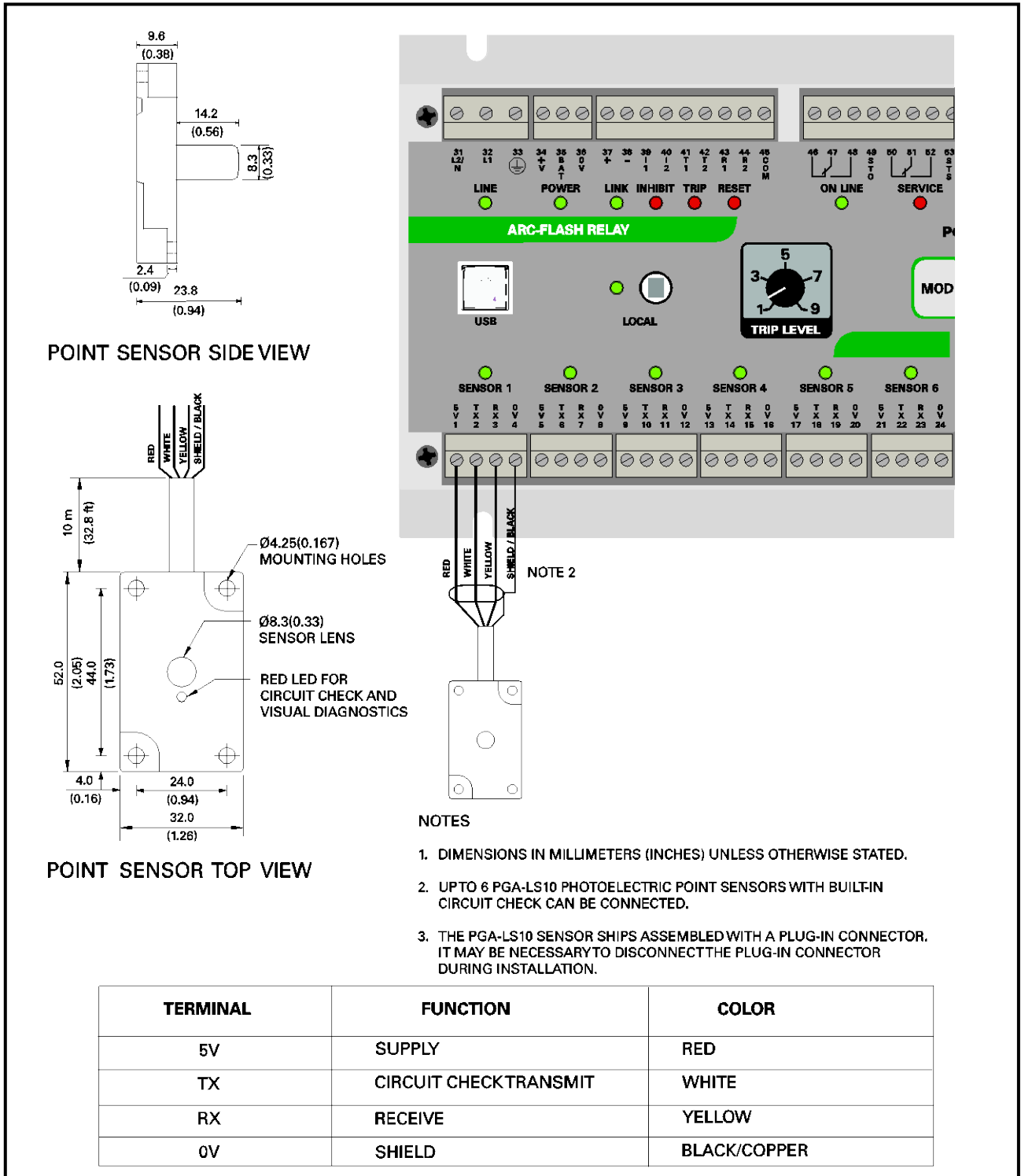

FIGURE 6. PGA-LS10 Connection Diagram.



**4.1.2 PGA-LS10 Installation**

The PGA-LS10 point sensor includes an adhesive-backed drill template for easy surface or panel-mount installation.

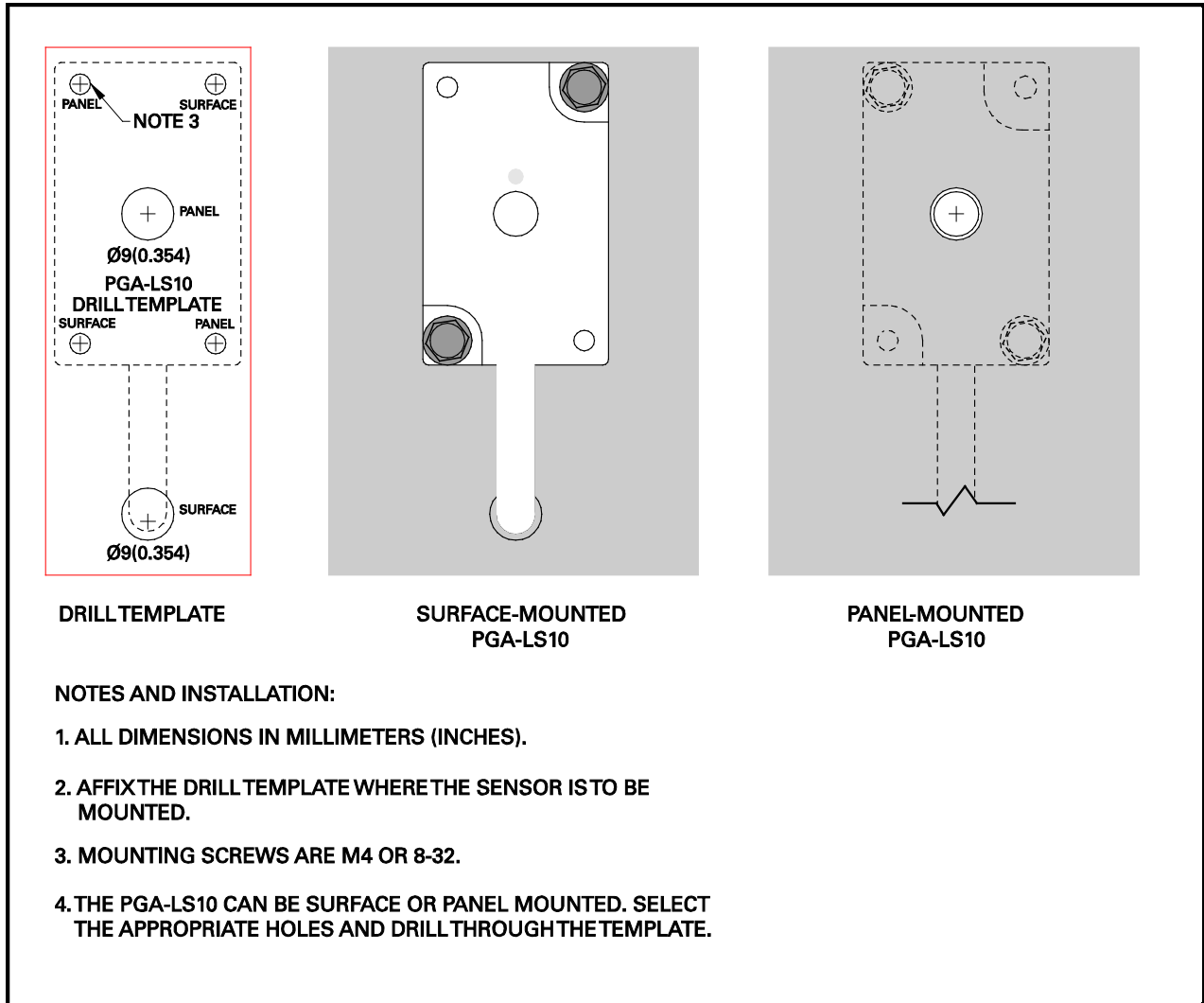

FIGURE 7. PGA-LS10 Mounting Detail.

## 4.2 PGA-LS20 and PGA-LS30 Fiber-Optic Sensors with Sensor Check

The PGA-LS20 and PGA-LS30 have a 360° detection zone along the fiber's length. A built-in LED enables the PGR-8800 to verify the function of the light sensor, wiring, and electronics. If the sensor does not detect the sensor-check LED, a sensor-fail alarm will occur -- the ONLINE output will change state and the ONLINE LED will begin to short flash. See Section 9.

The PGA-LS20 and PGA-LS30 sensors have three components:

1. A fiber-optic cable, with one end covered with a black sleeve. The PGA-LS20 has 8 m (26 ft) of active fiber and 2 m (7 ft) of covered fiber. The PGA-LS30 has 18 m (59 ft) of active fiber and 2 m (7 ft) of covered fiber.
2. A transmitter with a white enclosure and a white thumb nut.
3. A receiver with a white enclosure, a black thumb nut, and an adjustment screw behind an access hole.

Both the receiver and the transmitter connect to one PGR-8800 input using shielded three-wire electrical cable. All three components are monitored to ensure correct operation.

### 4.2.1 Fiber Connection

The fiber is the light-collecting element of the PGA-LS20 and PGA-LS30. It must be installed so it has line-of-sight to all current-carrying parts. In some cases this may be accomplished by following the bus bars along the back wall of the cabinets.

Drill holes using the included drill template and fasten the transmitter and receiver to the cabinet walls using rivets or screws. Connect the attached cables to the PGR-8800. The wires of the transmitter and receiver must be connected as shown in Fig. 8.

Connect the black-sleeve-covered end to the receiver using the black thumb nut, and the white uncovered end to the transmitter using the white thumb nut. Ensure the fiber is inserted completely into the transmitter and receiver and the nuts are tightened. Pull gently on the cable to verify a secure connection. The maximum pull strength of the fiber is 30 N (6.7 lbf).

The fiber should not be sharply bent or pinched. The minimum bending radius is 5 cm (2"). Ensure that any drilled holes are free of any sharp edges or burrs. Use grommets for further protection.

**NOTE:** Removing the fiber from the transmitter end only can cause a trip if the end of the fiber is pointed towards a light source, since the fiber conducts light. When servicing the arc flash relay, always place the unit in service mode before connecting and disconnecting sensors and fibers.

### 4.2.2 Receiver Wiring Connections

Connect the red wire to 5V.  
Connect the yellow wire to RX.  
Connect the white wire **and** the shield to 0V.

### 4.2.3 Transmitter Wiring Connections

Connect the red wire to 5V.  
Connect the white wire to TX.  
Connect the shield to 0V.

The yellow wire is not used.

### 4.2.4 PGA-LS20 and PGA-LS30 Connection

The sensor is shipped with the wires mounted in a terminal block. See Fig 8.

The transmitter and receiver include 10 m (33 ft) of shielded three-wire electrical cable which can be shortened or extended up to 50 m (164 ft). Transmitter and receiver cables can be different lengths and must be independently shielded. The following AWM styles (or equivalent) can be used:

- Style 2464, 20 AWG, 80 C rated, 300V, 3-conductor with shield
- Style 1316, 20 AWG, 105 C rated, 600V, 3-conductor with shield
- Style 21819, 20 AWG, 105 C rated, 600V, 3-conductor with shield

Failure to independently shield transmitter and receiver cables can lead to an incorrect circuit check – a faulty sensor could be falsely detected as continuous. However, if there is no sensor fault, arc-flash detection will function normally in this condition.

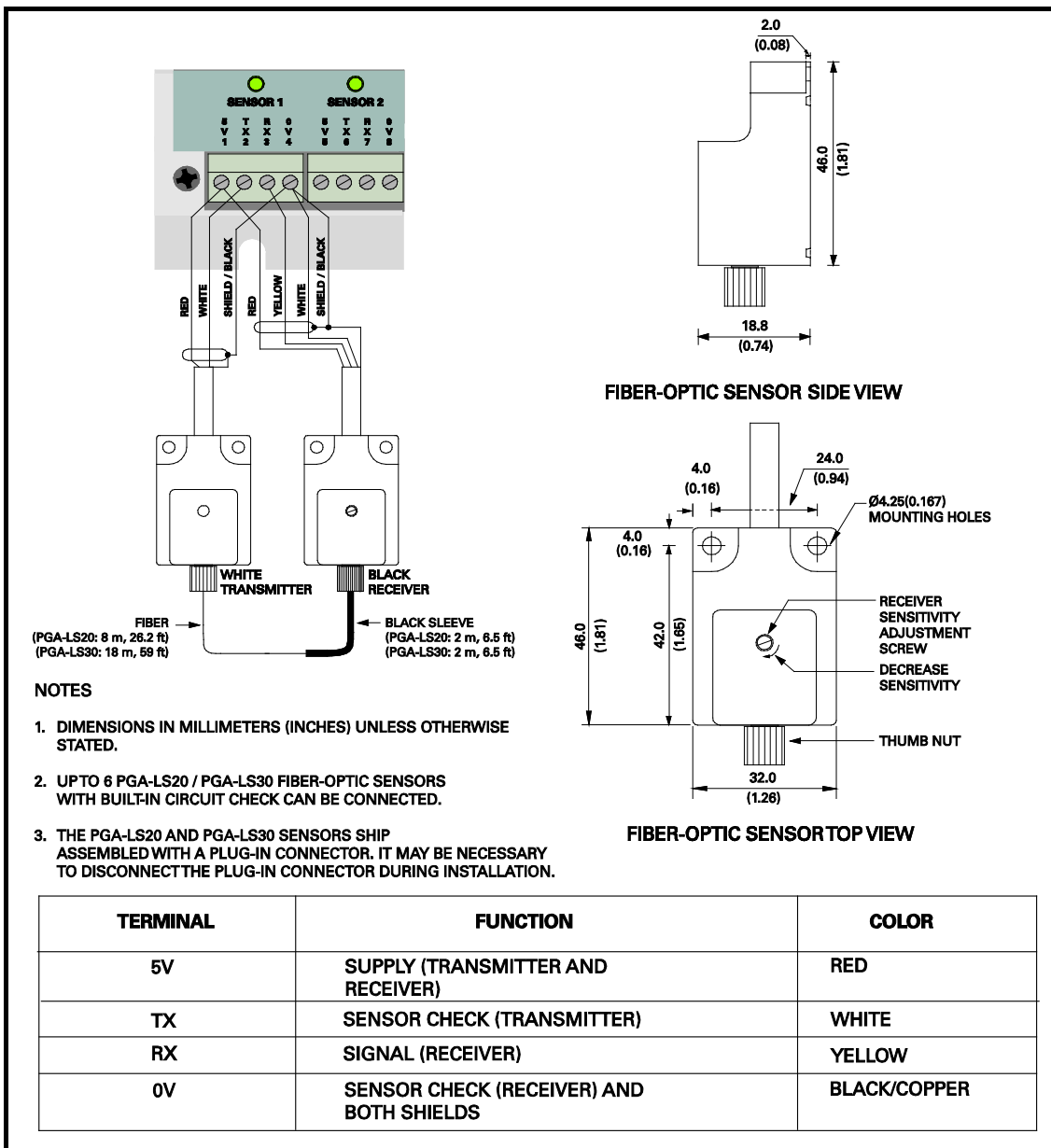

FIGURE 8. PGA-LS20 and PGA-LS30 Connection Diagram.

## 5 SENSOR PLACEMENT

### 5.1 General Guidelines

Optical sensors require line-of-sight to points being monitored. Ensure that the point sensors and fiber are not blocked by fixed or moveable objects. Areas that will be accessed for maintenance or with moveable parts (such as draw-out circuit breakers) should be considered a high priority for installation. Do not place sensors or cables on bare components that will be energized and avoid sharp bends in the cable, particularly when using the PGA-LS20 and PGA-LS30 fiber-optic sensors. The electrical cables and sensors should be considered to be at ground potential when determining electrical clearances.

Sensors should be mounted in a location that will minimize the chance of debris or dust build-up and with easy access for maintenance if needed. A point sensor mounted at the top of an enclosure and facing down is optimal for reducing dust build-up. It should be noted that most enclosures are metallic and the reflectivity combined with the high intensity of an arc mean that even a dirty sensor will collect adequate light.

Sensors can be tested individually by putting the PGR-8800 into service mode by pressing the MODE button and shining a bright light on the sensor. A trip will be indicated if the sensor detects the light, but a trip signal will not be sent to the circuit breaker. If the LED on the sensor or relay isn't indicating a trip, cleaning is necessary. Note that in service mode, the PGR-8800 will not trip if an arc flash occurs. Remember to return the PGR-8800 to online mode after testing is completed. In dusty environments, sensor cleaning should be part of a regular maintenance schedule and can be performed using compressed air or a dry cloth.

### 5.2 Switchgear Protection

The sensors used for arc-flash detection are optical sensors. Line-of-sight between the points where an arc could occur and the sensor is crucial.

Often one point sensor is sufficient to monitor a complete switchgear compartment. However, if there are large components such as circuit breakers that cast shadows over wider areas, more than one point sensor is required.

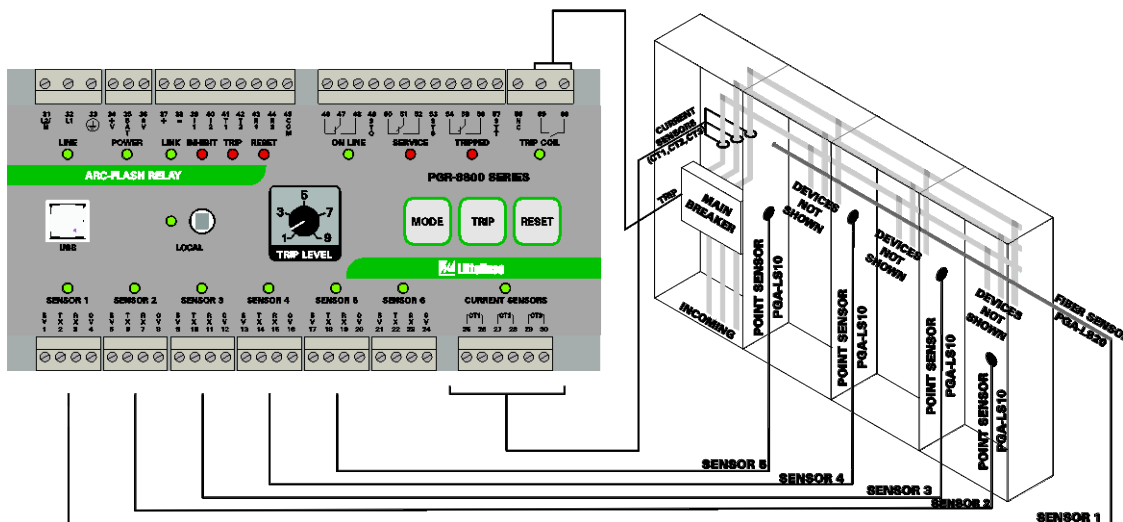

### 5.3 Transformer Protection

The PGR-8800 can also be used for the protection of transformers. Two or more point sensors should be used per transformer to monitor the primary and secondary connection terminals. For the placement of the sensors, the same considerations apply as for switchgear protection.

## 6 CURRENT SENSORS

The PGR-8800 has three phase-current inputs which can be configured in a current-supervised trip inhibit mode and for overcurrent protection.

The current inhibit mode prevents the module from tripping on a light signal, unless the current is above a threshold. This can prevent nuisance tripping e.g. photo flashes or welding in the area.

The overcurrent protection provides a fast, but less accurate ANSI 50 overcurrent protection function.

The current-sensor inputs can also be used to verify that the local circuit breaker has tripped successfully, providing an ANSI 50BF circuit breaker failure function. See Appendix C for more information.

### 6.1 Current Inhibit Mode

If the current-supervised trip inhibit mode is enabled, the PGR-8800 will only trip when the following conditions apply:

- An arc is detected by an optical sensor, and
- Current detected by a current sensor exceeds the inhibit threshold.

The PGR-8800 will trip after the programmed delay time for the light as soon as the absolute value of the current on any phase exceeds the inhibit setting. Thus, the current inhibit does not add any delay to the trip if the arc is drawing current.

### 6.2 Overcurrent Protection

In addition, two definite-time overcurrent protection levels are provided that will trip on current detection alone. Overcurrent levels can be set from 150 to 1,000% of rated nominal load current. Overcurrent protection is not active by default, and must be set using the configuration software.

Overcurrent trip times can be set between 1 and 20,000 milliseconds. The trip decision is based on an internal counter. The PGR-8800 will increment the counter if a sample exceeds the trip-level setting and decrement it when a sample is below the setting. When the counter exceeds the number of samples necessary to exceed the time delay, the PGR-8800 will trip. The time for the trip coil IGBT (insulated-gate bipolar transistor) to operate is approximately 0.2 milliseconds, which happens after the time delay.

**NOTE:** Using overcurrent trip on a system with fewer than three phase current sensors can significantly increase trip times and levels. This does not apply to the inhibit system, which will function at no added delay, also in single phase systems.

### 6.3 Current Sensor Characteristics

The current-sensor inputs require 5-A-secondary current sensors. Three phase-current sensors are required for optimal performance. For best performance, select current sensors with a primary rating approximately equal to the system's rated current and protection class 10P5 or better. The current sensors can be placed in series with other equipment as long as the total burden of the wiring and inputs are within the current sensor rating.

The PGR-8800 measures instantaneous currents and is insensitive to phasing and polarity. The current-sensor inputs have a burden of less than 0.25 VA at 5 A, will withstand up to 75 A for one second, and are isolated from all other terminals up to 500 Vac.

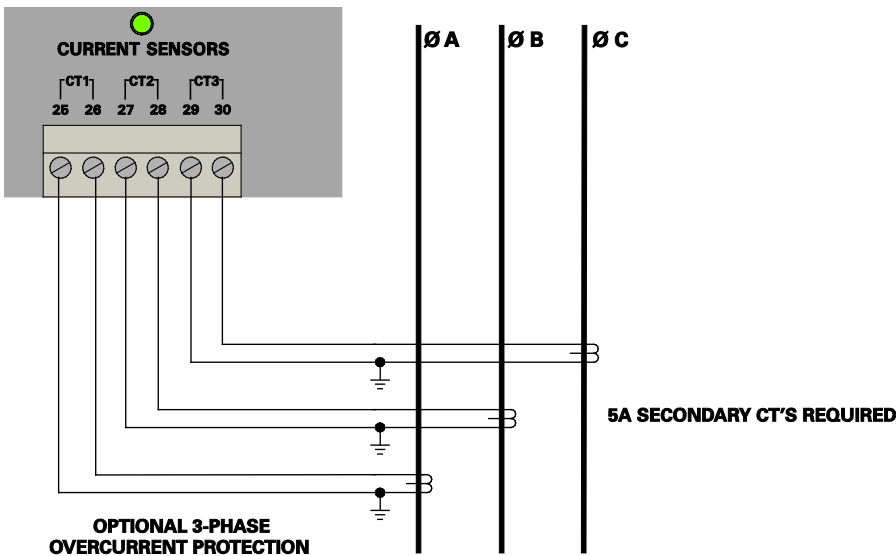

## 7 DIGITAL INPUTS

The PGR-8800 has three digital-input functions; trip inhibit, trip and reset. Each function has two inputs to simplify wiring.

By default, the inputs are considered active when connected to COM (terminal 45). The inputs can also be configured to be active when not connected to terminal 45 and to use circuit check in the configuration software. See Section 12.2.7.

### 7.1 Inhibit

The INHIBIT function suppresses a trip signal.

There are two INHIBIT inputs: terminals 39 and 40.

When inhibit is activated, the PGR-8800 will indicate that an arc fault is being detected, but will not pulse the trip-coil output. If the PGR-8800 detects an arc fault while inhibited, the sensor LED and INHIBIT LED will flash.

Inhibit can also block a digital-input if so configured. See Section 12.2.7. The INHIBIT input is enabled by default.

### 7.2 Trip

The TRIP input is used to remotely trip the PGR-8800. Once activated, the PGR-8800 will pulse the TRIP COIL output instantaneously.

There are two TRIP inputs: terminals 41 and 42.

In SERVICE mode, this input does not affect the TRIP COIL output.

The TRIP input can also be configured to connect to the auxiliary contact of a circuit breaker to verify that the circuit breaker has tripped successfully. See Appendix C.

The TRIP input is enabled by default.

### 7.3 Reset

The RESET input is used as a remote reset after a fault has been detected.

There are two RESET inputs: terminals 43 and 44.

Activating this input will reset an alarm or error, clear the TRIPPED and TRIP COIL outputs, clear the indicators, and place the unit back in service or online mode, depending on the mode it was operating in prior to the trip.

If the reset input is permanently connected to COM, the PGR-8800 will auto reset after a trip has occurred. The reset input is enabled by default.

### 7.4 Circuit Check

A circuit-check feature can be enabled for each digital input in the configuration software. This feature will cause the module to report an error if the connection to the digital input is open or broken. Circuit check requires an 82 kΩ resistor connected in parallel with the external contact. This resistor must be connected as close as possible to the contact to ensure the full-length of the cable is protected.

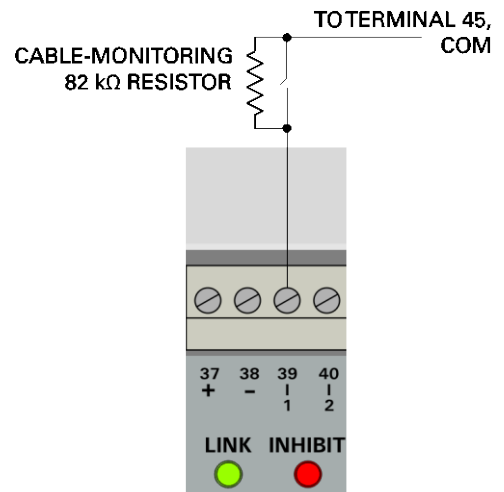
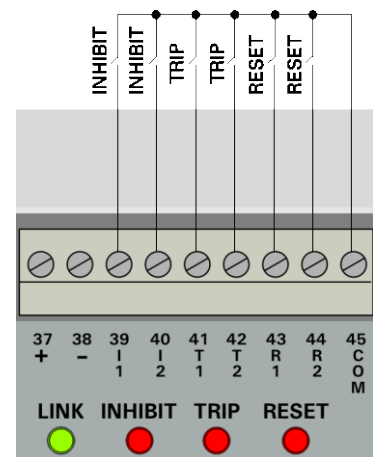

## 8 OUTPUTS

An LED provides visual indication of each output status. The output contacts are shown on the faceplate in the powered-off state. Starting with firmware v1.03.16, additional functionality has been added to the outputs.

### 8.1 Online

The ONLINE output consists of two contact sets:

- A change-over (Form C) contact (terminals 46-48)
- A normally-open status contact, STO (terminal 49) with reference to COM (terminal 45)

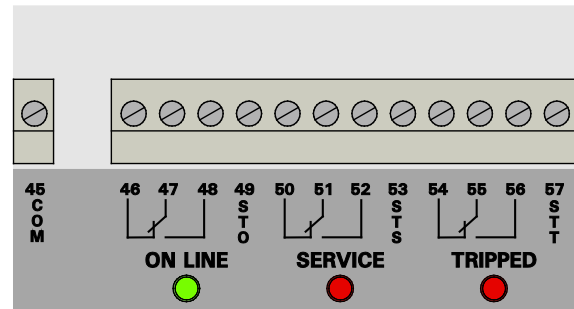

When the ONLINE output function is set to Indicate Online Operation, the ONLINE output is energized unless the PGR-8800:

- detects an optical sensor fault,
- detects a cable fault on a digital input if cable monitoring is activated in the configuration software,
- detects loss of trip coil supply voltage,
- loses supply voltage, or
- is in service mode.

When the ONLINE output function is set to Trip Zone and Online Operation, the ONLINE output is energized unless the PGR-8800:

- detects an optical sensor fault,
- detects a cable fault on a digital input if cable monitoring is activated in the configuration software,
- detects loss of trip coil supply voltage,
- loses supply voltage,
- is in service mode,
- detects an arc flash at one of the selected light sensors, or
- trips due to a Trip Input or Link Trip if configured.

When the ONLINE output function is set to Trip Zone:

- the LED on the overlay will still indicate if the relay is in online mode, and
- the output contacts will operate as configured:
  - Continuous or Pulsed Online Output Type
  - Fail-safe or Non-fail-safe Output Operating Mode
  - When an arc flash occurs at one of the selected light sensors
  - Trip Input or Link Trip trips this zone if configured

When the ONLINE output function is set to Current Detected:

- The LED on the overlay will still indicate if the relay is in online mode.
- Current Inhibit must also be enabled in the Current Sensors tab.



- When current is greater than the Trip Inhibit value, the ONLINE output will immediately de-energize in non-fail-safe mode (or energize in fail-safe mode).
- When current is less than the Trip Inhibit value, the ONLINE output will energize in non-fail-safe mode (or de-energize in fail-safe mode) after a three second delay.

See Section 12 for configuration details.

## 8.2 Service

The SERVICE output consists of two contact sets:

- A change-over (Form C) contact (terminals 50-52)
- A normally-open status contact STS (terminal 53) with reference to COM (terminal 45)

When the SERVICE output function is set to Indicate Service mode, the SERVICE output signals that the PGR-8800 is being commissioned or set up. The output is energized when the PGR-8800:

- is in service mode, or
- is connected via USB to a PC

When the SERVICE output function is set to Trip Zone:

- the LED on the overlay will still indicate if the relay is in service mode, and
- the output contacts will operate as configured:
  - Continuous or Pulsed Online Output Type
  - Fail-safe or Non-fail-safe Output Operating Mode
  - When an arc flash occurs at one of the selected light sensors
  - Trip Input or Link Trip trips this zone if configured

When the SERVICE output function is set to Current Detected:

- The LED on the overlay will still indicate if the relay is in service mode.
- Current Inhibit must also be enabled in the Current Sensors tab.
- When current is greater than the Trip Inhibit value, the SERVICE output will immediately de-energize in non-fail-safe mode (or energize in fail-safe mode).
- When current is less than the Trip Inhibit value, the SERVICE output will energize in non-fail-safe mode (or de-energize in fail-safe mode) after a three second delay.

See Section 12 for configuration details.

The SERVICE output can also be configured to trip an upstream device after a local circuit-breaker failure or to follow the Trip Coil output. See Appendix C.

## 8.3 Tripped

The TRIPPED output consists of two contact sets:

- A change-over (Form C) contact (terminals 54-56)
- A normally-open status contact STT (terminal 57) with reference to COM (terminal 45)

**NOTE:** The TRIPPED output is used for signalling a trip condition to a remote monitoring system or to trip an upstream circuit breaker. It is not intended to trip the local circuit breaker due to the slower response time of a mechanical relay.

When the TRIPPED output function is set to Indicate that the unit tripped, the TRIPPED output will energize if the PGR-8800 detects a fault during regular operation or in service mode.

When the TRIPPED output function is set to Trip Zone:

- the LED on the overlay will still indicate if a trip occurred in any zones, including Link mode
- the output contacts will operate as configured:
  - Continuous or Pulsed Online Output Type
  - Fail-safe or Non-fail-safe Output Operating Mode
  - When an arc flash occurs at one of the selected light sensors
  - Trip Input or Link Trip trips this zone if configured

When the TRIPPED output function is set to Current Detected:

- The LED on the overlay will still indicate if a trip occurred in any zones, including Link mode.
- Current Inhibit must also be enabled in the Current Sensors tab.
- When current is greater than the Trip Inhibit value, the TRIPPED output will immediately de-energize in non-fail-safe mode (or energize in fail-safe mode).
- When current is less than the Trip Inhibit value, the TRIPPED output will energize in non-fail-safe mode (or de-energize in fail-safe mode) after a three second delay.

See Section 12 for configuration details.

The TRIPPED output can also be configured to trip an upstream device (with a delay of approximately five milliseconds) after a local circuit-breaker failure, or to follow the TRIP COIL output. See Appendix C.

### **8.4 Trip Coil**

Use the TRIP COIL output to trip a shunt or undervoltage circuit breaker. The operating mode is programmable using the PGR-8800 configuration software. See Section 12.2.8.

The TRIP COIL output can be used for trip coils with a 24 to 300 Vac/Vdc supply voltage. The output is monitored to verify that there is voltage available to the tripping circuit. If voltage is not detected, the ONLINE output will change state (if configured) and its LED will flash green.

When the TRIP COIL output function is set to Indicate that the unit tripped:

- the output contact will operate as configured:
  - Continuous or Pulsed Online Output Type
  - Shunt coil or Undervoltage coil circuit breaker type
  - arc flash occurs at any of the light sensors

When the TRIP COIL output function is set to Trip Zone:

- the LED on the overlay will indicate the Trip Coil status. Refer to Section 9 for details.
- the output contacts will operate as configured:
  - Continuous or Pulsed Online Output Type
  - Fail-safe or Non-fail-safe Output Operating Mode
  - arc flash occurs at one of the selected light sensors
  - Trip Input or Link Trip trips this zone if configured

When the TRIP COIL output function is set to Current Detected:

- the LED on the overlay will indicate Trip Coil status. Refer to Section 9 for details.
- must also enable Current Inhibit in the Current Sensors tab
- When current is greater than the Trip Inhibit value, the TRIP COIL output will immediately de-energize in non-fail-safe mode (or energize in fail-safe mode).
- When current is less than the Trip Inhibit value, the TRIP COIL output will energize in non-fail-safe mode (or de-energize in fail-safe mode) after a three second delay.

See Section 12 for configuration details.

The TRIP COIL output is a pulsed output when in shunt trip mode. When an arc flash is detected, the TRIP COIL output is activated in less than one millisecond. When overcurrent protection is enabled and an overcurrent is detected, the TRIP COIL output is activated after an adjustable delay. The TRIP COIL output is deactivated after the adjustable pulse period delay. The output is an IGBT that can carry 10 A ac or dc for five seconds.

The TRIP COIL output is isolated up to 1,000 Vac.

**NOTE:** The TRIP COIL output is an IGBT switch. There is a voltage drop of 2-4 V across the TRIP COIL output when energized. See Section 14.

The TRIP COIL output consists of a rectifier bridge and an IGBT. The IGBT is able to switch large currents and high voltages. In combination, this creates a very fast relay-like switch which is able to trip even large circuit breakers without the added delay of a mechanical relay.

**NOTE:** The TRIP COIL output functions as a momentary switch and is protected against thermal overload. It will gradually lower the time the trip coil is active if the PGR-8800 is tripped repeatedly.

By default, when the PGR-8800 is in service mode, the TRIP COIL output will not operate when an arc-flash or overcurrent trip occurs, but it will operate when the TRIP button is pressed for at least one second. The TRIP COIL output can also be programmed to trip while in service mode using the configuration software.

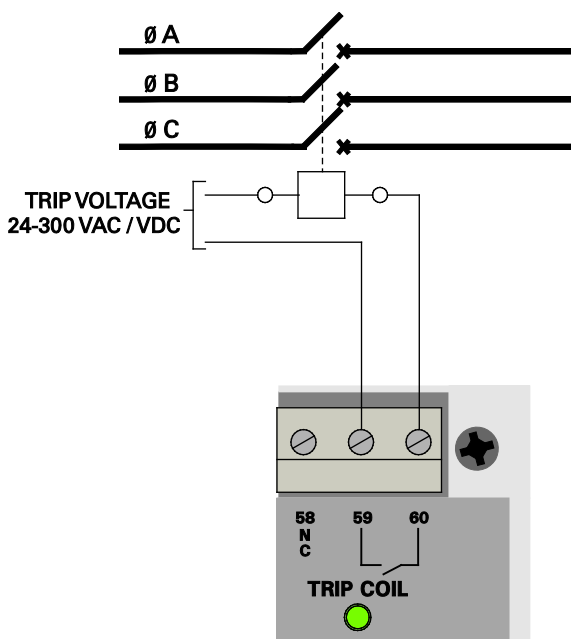

## 9 LED INDICATION

### LINE

On, green                      Supply voltage is connected  
 Off                                Supply voltage is not connected

### POWER

On, green                      PGR-8800 is running from a supply other than battery  
 Slow green flashing        PGR-8800 is running from the Battery input. The PGR-8800 will shut down at 20 V to protect the battery from damage  
 Short green flashing        PGR-8800 is charging a battery  
 Off                                PGR-8800 is not powered

### LINK

On, green                      Link mode is enabled and active  
 Green flashing (intermittent)        Network traffic indication  
 Slow red flashing            A relay in the system is tripping. If the trip is locally inhibited, the Link LED will revert to green when the trip source is removed  
 Short red flashing            Link mode is enabled but not all relays are being detected  
 Off                                Link mode is disabled

### INHIBIT

On, red                         INHIBIT input is active or current sensing is inhibiting trips (current not above setting)  
 Fast red flashing            The PGR-8800 detects an arc (light), but the INHIBIT input or current sensing is preventing a trip  
 Short red flashing            Digital-input circuit check failed; check the wiring of the inputs, or use the configuration software to disable circuit check  
 Off                                INHIBIT input is inactive

### TRIP

On, red                         TRIP input or another trip source is active  
 Fast red flashing            TRIP input is causing a trip  
 Slow red flashing            Last trip was caused by this input or by the TRIP button on the front panel. Press RESET in Online mode to clear the trip  
 Short red flashing            Digital-input circuit check failed; check the wiring of the inputs, or use the configuration software to disable circuit check  
 Off                                TRIP input is inactive

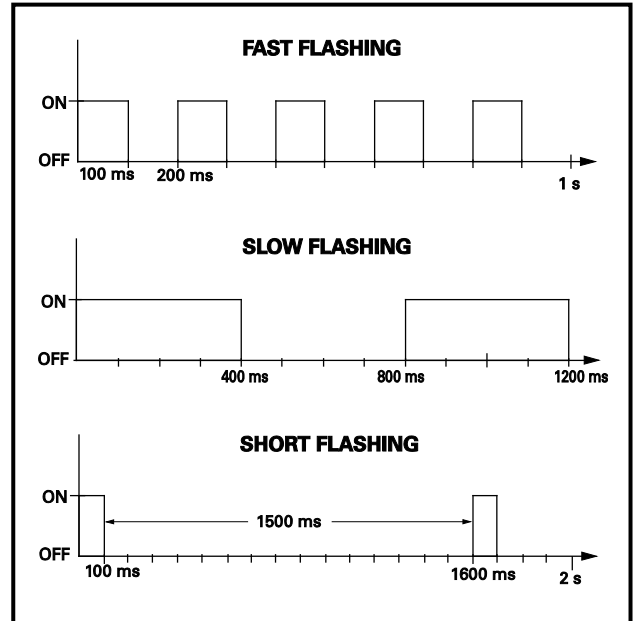

FIGURE 9. LED Flash Patterns.

**RESET**

On, red	RESET input or another reset source is active
Short red flashing	Digital-input circuit check failed; check the wiring of the inputs, or use the configuration software to disable circuit check
Off	RESET input is inactive

**ONLINE**

On, green	PGR-8800 is online, active and operational; the TRIP COIL output will pulse if trip conditions are met
Short green flashing	PGR-8800 has detected an error. The front-panel LED's will provide error information. The TRIP COIL output will still operate if trip conditions are met
Off	PGR-8800 is off or in service mode

**SERVICE**

On, red	PGR-8800 is in service mode. Please note it will switch to and stay in service mode if a USB cable and PC are connected. In service mode, the TRIP COIL output can be activated from the front-panel TRIP button but not by an arc fault, overcurrent, or TRIP input, unless configured to trip in service mode. See Section 12.2.8.  Press and hold RESET to configure the sensors. See Section 13.1.
Short red flashing	PGR-8800 is in service mode, and has detected an error. The front-panel LED's will provide error information
Slow red flashing	PGR-8800 is in the process of auto set up or firmware update
Off	PGR-8800 is off or in online mode

**TRIPPED**

On, red	The TRIP COIL output is or has been active or was prevented from activating while in service mode. Press RESET to clear the trip
Off	No unacknowledged trips

**TRIP COIL**

On, green	TRIP COIL output is ready and detects trip voltage of 5 V or more in shunt mode
Fast red flashing	TRIP COIL output is activated due to an existing trip event and is currently pulsing the output
Slow red flashing	TRIP COIL output has been activated and has completed the pulsed output. Press RESET to clear the trip
Short red flashing	TRIP COIL output is blocking less than 5 V. The trip voltage is missing; check the wiring and the power supply to the trip coil

**LOCAL**

On, green	Online mode. The front-panel sensor is configured for use as a trip sensor The LED may also indicate that the PGR-8800 is powering up if it is the only lit LED. If this condition remains for an extended period, it indicates unit error
Slow green flashing	If the SERVICE LED is also flashing, the PGR-8800 is awaiting manual confirmation of the connected sensors. See Section 13.1
Fast green flashing	The internal supervisor or a USB host is reading or writing to internal memory, or the light detected on the front sensor is close to trip level

**SENSORS**

On, green	SENSOR input is active and has a connected sensor
Fast green flashing	Sensor is currently detecting more than 50% of the light level needed to trip. The level at which this occurs is programmable. This is a warning only. If this warning is active during normal condition, it may indicate that the system Trip Level is set too low, which could lead to unintentional tripping
Slow red flashing	Sensor caused a trip event. Press RESET to clear the trip
Short red flashing (All sensors)	Sensor check of the sensor failed; check the wiring and, if using a PGA-LS20 or PGA-LS30 ensure the small metal adjustment screw is not set to minimum sensitivity. See Section 13.
Off	SENSOR input is inactive

**CURRENT SENSORS**

On, green	Current sensors are activated and configured
On, red	Current is above the inhibit level
Fast green flashing	Current sensors are detecting more than 50% of the current level needed to trip. The level at which this occurs is programmable. This is a warning only. If this warning is active during normal condition, it may indicate that the system Trip Level is set too low, which could lead to unintentional tripping
Fast red flashing	Current sensor is causing a trip event
Slow red flashing	The PGR-8800 has tripped on overcurrent. Press RESET in online mode to clear the trip
Off	Current sensors are inactive

**PGA-LS10, PGA-LS20, PGA-LS30**

Short red flashing	Sensor is operating normally. Double flashes occur every few seconds
Slow red flashing	Sensor has detected an arc
Off	Sensor inactive

## **10 PGR-8800 BUTTONS**

### **10.1 Mode**

The MODE button switches the PGR-8800 between online and service mode.

### **10.2 Trip**

In service mode, when the TRIP button is pressed for more than one second, the TRIP COIL output is activated. In online mode, the TRIP button is disabled.

### **10.3 Reset**

In online mode, press the RESET button to clear a trip (if trip conditions are no longer present). In service mode, when the RESET button is pressed for more than one second, the optical sensor detection process will begin. See Section 13.1.

### **10.4 Mode + Reset**

When MODE and RESET are pressed for more than 20 seconds, a file system reset will occur. This will erase the logged information.

### **10.5 Mode + Trip**

When MODE and TRIP are pressed for more than 20 seconds, a reset of all configuration settings to factory defaults will occur. This will not clear the logged information on the file system.

## 11 LINK

The PGR-8800 Link function allows up to four PGR-8800 modules to be connected to form a single system. This enables the PGR-8800 to share sensor inputs and relay outputs as if they were one unit. The maximum link cable length is 10 m (33 ft).

It is necessary to configure the Link function before use. See Section 12.2.9.

### 11.1 Configuration

Set the Link interface, address, and number of connected modules with the configuration software.

Each PGR-8800 must have a unique link address, starting from one for the module connected to the local circuit breaker.

The PGR-8800 Link function continuously monitors link-cable-break faults.

### 11.2 Button Function

When a PGR-8800 is configured for the Link function, the front buttons can be shared with all modules in the system or set to apply only to the local module. For example, if one PGR-8800 is set to service mode and Link user interface is enabled, all the linked modules will be placed in service mode. This also applies to the RESET button.

The TRIP button is only applied locally. If the TRIP button is pressed in service mode, only the local module will trip.

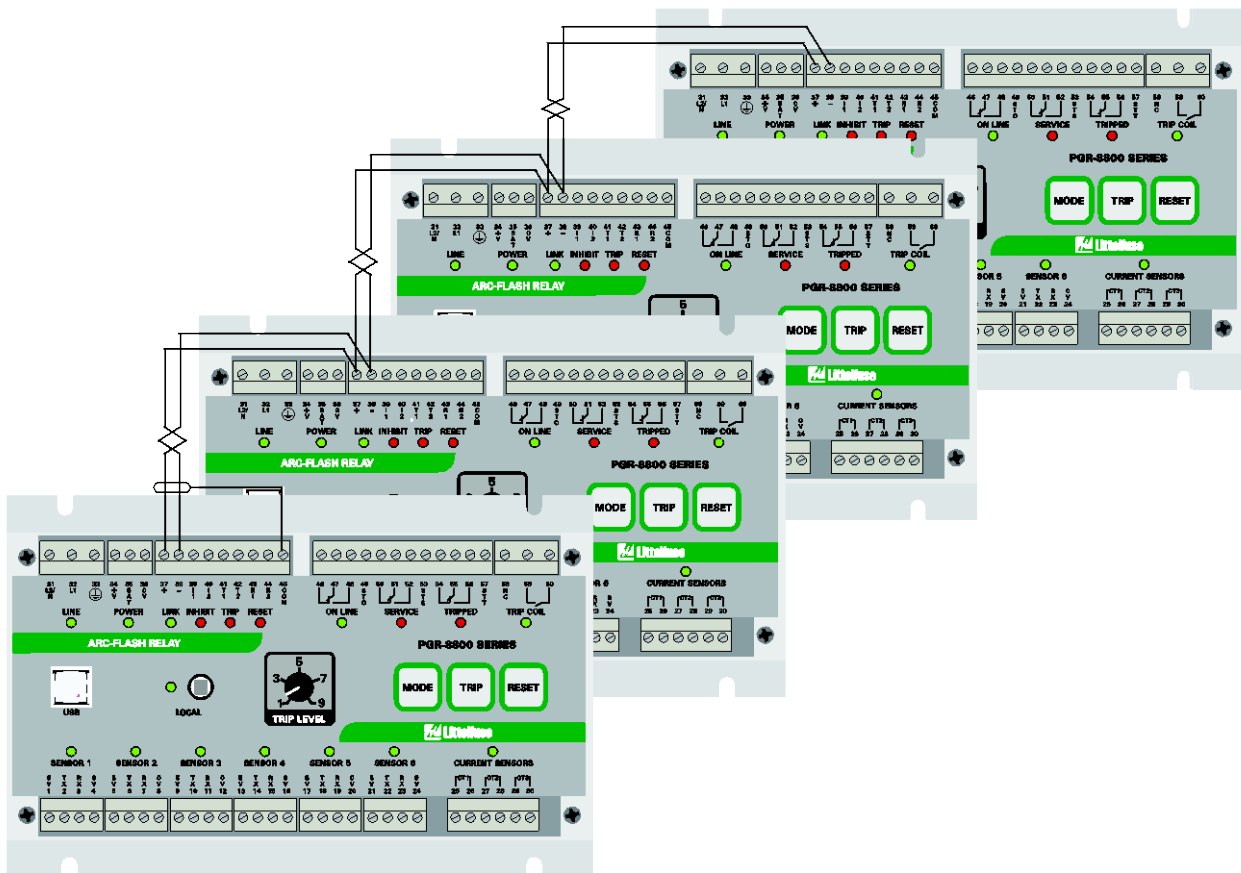

When connecting modules using the Link interface, connect terminals 37 and 38 as shown using Belden 3105A cable, or equivalent.



### 11.3 Modbus Communication

The MODBUS<sup>®</sup> RTU protocol is implemented in the PGR-8800, and allows up to four modules to be connected using a 2-wire TIA-485 bus. The PGR-8800 can also be connected to a local HMI or SCADA system. This will provide status information for sensors, analog inputs, digital inputs, digital outputs, and numerous event and error flags. It also provides the ability to remotely reset the PGR-8800. A converter for TIA-485 to Ethernet, IEC-61850, or other network type can be used for remote network connections and many other communications options.

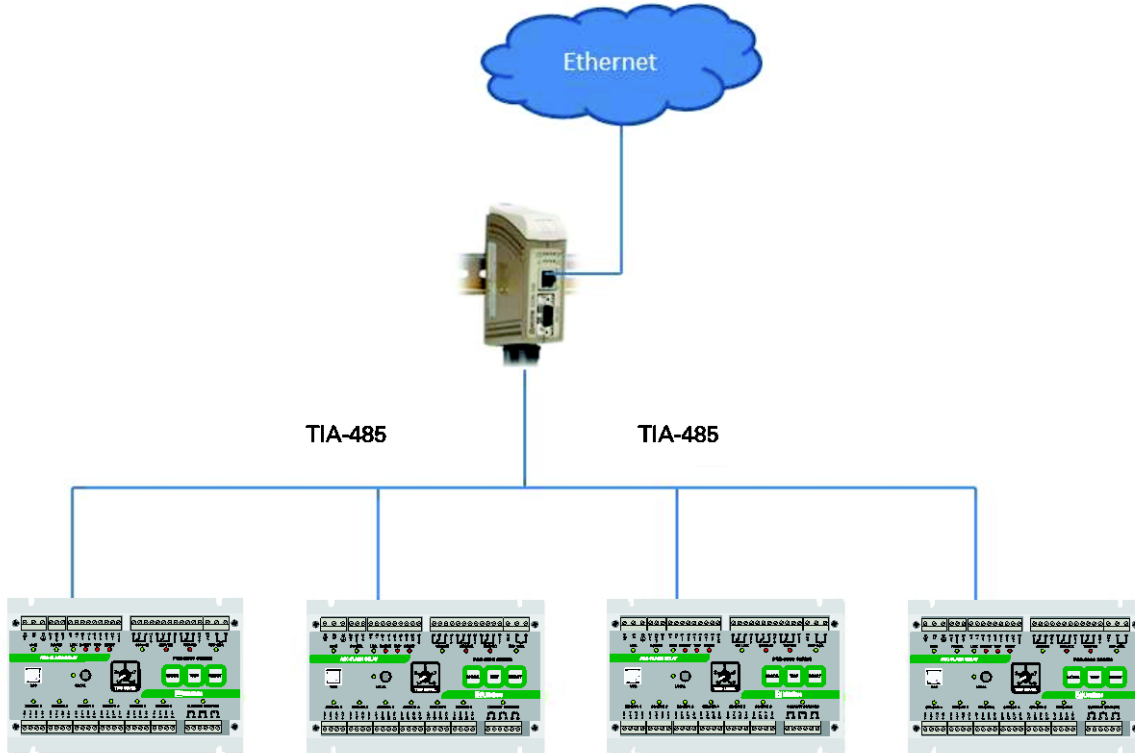

Set the Modbus interface and address with the configuration software. Each PGR-8800 must have a unique Modbus address. See Section 12.2.9 and Appendices A and B.

Terminal	Description	Signal	Connection
37	B +	TIA-485 B	B signal of the TIA-485 bus
38	A -	TIA-485 A	A signal of the TIA-485 bus

The 2-wire multi-drop TIA-485 bus requires common terminals to be connected (terminals 37 to 37, 38 to 38). The maximum cable length is 10 m (33 ft) and must be shielded twisted pair. Use Belden 3105A cable, or equivalent.

**NOTE:** If Modbus registers are polled continuously, the configuration program may occasionally stutter for a few seconds. This has no influence on real-time behavior and trip times, since both the Modbus protocol and the USB device execute as separate low-priority tasks.

## 12 USB INTERFACE

The PGR-8800 contains configuration software, data logs, and event records that can be accessed through the USB Interface. No drivers or software installation is required to access configuration or data. Use a USB A-B cable as shown below to connect the PGR-8800 to a computer.

The PC application for configuring the PGR-8800 is pre-installed on the internal Configuration drive. When the PGR-8800 is connected to a PC, the Configuration drive (wrench icon) and the Log drive (notepad icon) will appear in the file manager as shown in Section 12.1.



This makes it possible to automate configuration if several relays with the same configuration are needed. Contact Littelfuse for more information.

**NOTE:** The configuration and log-viewer applications are HTML Applications (HTA). HTA is a proprietary Microsoft™ technology and is only supported by Internet Explorer 5.0 or later on Microsoft Windows systems. Once configured, the data log file can be accessed on any platform.

### 12.1 Connecting to a PC

The PGR-8800 requires supply voltage before connecting the USB cable. Although some LED's may light when connecting a USB cable to an unpowered PGR-8800, the USB interface does not supply adequate power to allow proper operation.

A powered PGR-8800 will enter service mode when a PC is connected with a USB cable. In service mode, arc-flash protection is inactive by default, but can be configured to trip in service mode. See Section 12.2.8. The PGR-8800 will remain in service mode until the USB cable is disconnected and the MODE button is pressed to return to online mode. When connected to a PC, the PGR-8800 appears as two mass-storage devices and two drives will be displayed in the file manager. These drives are internal to the PGR-8800 and behave like any standard drive. Files can be copied to or from the drives or even dragged and dropped.

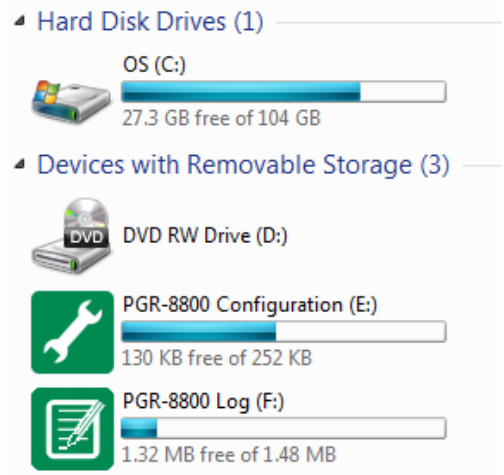

**NOTE:** The changes made in the configuration software will not be stored unless saved. The configuration changes will be activated when the USB cable is disconnected.

**NOTE:** The Log drive operates as a First-In, First-Out (FIFO) log. When the Log drive is full, the oldest entry will be removed to make room for a new event.

## 12.2 Configuration Software

The configuration software for the PGR-8800 is located on the Configuration drive (the wrench icon). To run the software, open the Configuration drive in the PC file manager and double-click on the config.hta file. The program will open in Internet Explorer regardless of the default browser. The features of the software are outlined in subsequent sections of this manual.

For any setting or button, hovering the mouse cursor over it will display the possible values of the setting or the function of the button.

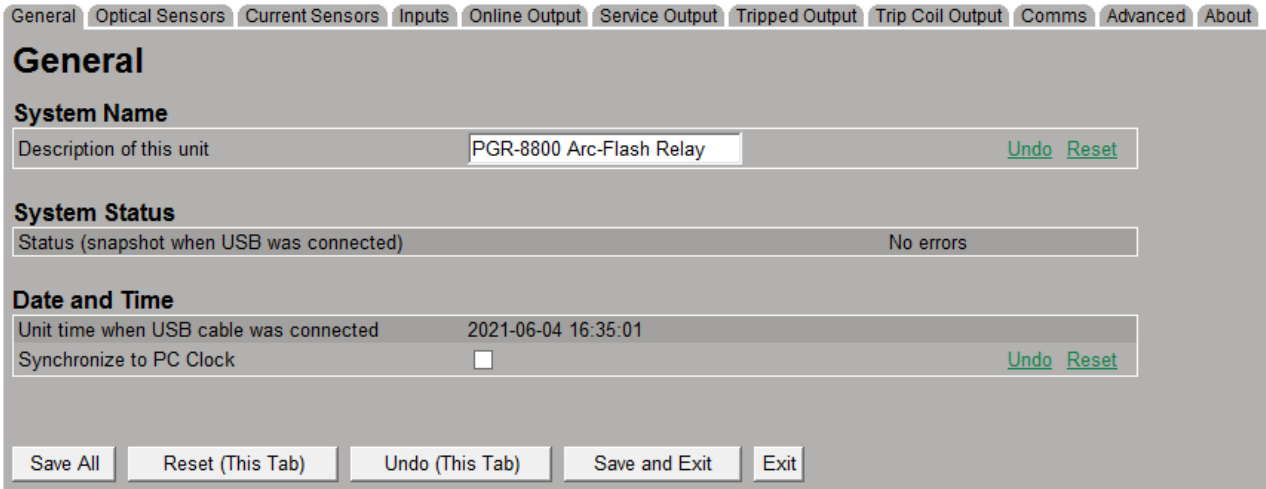

### 12.2.1 Configuration Software Tabs

The configuration software is displayed in a window with eight tabs along the top of the screen. Click on a tab to display the relevant configuration options.

<b>General</b>	Set the date, time, and a general description of the relay.
<b>Optical Sensors</b>	Configure optical sensors and arc-detection time before tripping.
<b>Current Sensors</b>	Set overcurrent and current-supervised arc-flash protection parameters.
<b>Digital Inputs</b>	Configure or disable the operation of the digital inputs.
<b>Trip Output</b>	Define the behaviour and pulse time of the Trip Coil output.
<b>Communications</b>	Link multiple PGR-8800 relays together into a single system or configure Modbus.
<b>Advanced</b>	Enable data logging or restore configuration and factory defaults.
<b>About</b>	View information on firmware and hardware versions.

### 12.2.2 Configuration Software Buttons

There are five buttons along the bottom of the configuration software window that are common to every tab.

<b>Save All</b>	Save all configuration settings made in every tab.
<b>Reset (This Tab)</b>	Reset all configuration settings in this tab to the factory default. Changes will not be stored until they are saved.
<b>Undo (This Tab)</b>	Undo any changes that have been made to the current tab since opening the configuration software.
<b>Save and Exit</b>	Save all configuration settings made in every tab and exit the configuration software.
<b>Exit</b>	Exit the configuration software. No changes will be saved unless the Save All button has been pressed. If the Save All button is clicked accidentally, use the Undo (This Tab) button on any tab where changes were made and then Save and Exit.

There are two buttons for each configuration setting, Undo and Reset. The Undo button will cancel any changes made to the value before the configuration software was opened. The Reset button will load the factory default for that setting.

### 12.2.3 Default Configuration

It is possible to use the basic protection features of the PGR-8800 without using the configuration software. Any connected optical sensors with circuit-check will be automatically detected and cause the relay to report an error if subsequently disconnected.

The initial configuration can be stored permanently without use of the configuration software by using the commissioning procedure outlined in Section 13.1. By default, the local sensor will not cause a trip on excess light.

The PGR-8800 current sensors are disabled by default; sufficient light alone will cause an arc-flash trip and overcurrent conditions will not cause a trip.

The amount of time that light must be detected to cause a trip is set at the factory to one millisecond. The cable-check feature for the digital inputs is disabled by default, but the inputs will function if they are connected to terminal 45.

The default trip pulse time is one second.

The configuration software is required to enable data logging, Link, MODBUS, and current sensor functions.

## 12.2.4 General Settings



### PGR-8800 Configuration Software

[General](#)
[Optical Sensors](#)
[Current Sensors](#)
[Inputs](#)
[Online Output](#)
[Service Output](#)
[Tripped Output](#)
[Trip Coil Output](#)
[Comms](#)
[Advanced](#)
[About](#)

#### General

**System Name**

Description of this unit:  [Undo](#) [Reset](#)

**System Status**

Status (snapshot when USB was connected): IGBT is unpowered

**Date and Time**

Unit time when USB cable was connected: 2021-01-14 13:32:05

Synchronize to PC Clock:  [Undo](#) [Reset](#)

Copyright (c) 2011-2021. [Littelfuse Inc.](#) All rights reserved.  
 See [PGR-8800 manual](#) for further details.

#### System Name

The system name can help identify the PGR-8800 (up to 25 characters) e.g. name and number of the switchboard section in which the unit is mounted.

#### Date and Time

This section will show the current date and time on the PGR-8800 and provides the option to synchronize with the connected PC.

## 12.2.5 Optical-Sensor Settings

[General](#)
[Optical Sensors](#)
[Current Sensors](#)
[Inputs](#)
[Online Output](#)
[Service Output](#)
[Tripped Output](#)
[Trip Coil Output](#)
[Comms](#)
[Advanced](#)
[About](#)

#### Optical Sensors

**Common Settings**

Arc detection time before tripping:  ms [Undo](#) [Reset](#)

Sensor LED flashes green as a threshold warning:  [Undo](#) [Reset](#)

Sensor Sensitivity:  [Undo](#) [Reset](#)

#### Common Settings

These settings apply to all optical sensors. The arc detection time specifies the amount of time light from an arc must be detected to cause a trip.

Valid settings are 0 to 20,000 milliseconds and the default setting is 1 millisecond. If set to zero milliseconds, the effective trip time is less than 0.8 milliseconds. If a sensor detects light approaching

the trip level, the LED for that sensor will begin to flash. The threshold for the warning flashes can be set to 50%, 75% (default), or 90% of the trip-level setting.

Sensor sensitivity can be set to Standard (default) or Sensitive. In the Standard mode, the Trip Level dial on the front panel can be adjusted from 1 to 9 (corresponding to 9 to 25 klux). In the Sensitive mode, the Trip Level dial can be adjusted from 1 to 9 (corresponding to 3 to 25 klux).

### Individual Sensor Settings

Sensor 1	
Sensor status	Sensor detected
Sensor description	<input type="text" value="Sensor 1"/> <a href="#">Undo</a> <a href="#">Reset</a>
Ignore sensor check errors	<input type="checkbox"/> <a href="#">Undo</a> <a href="#">Reset</a>
Change configuration	<input type="button" value="No change"/> <a href="#">Undo</a> <a href="#">Reset</a>

Optical sensors are individually configurable with a 25-character description. The PGR-8800 scans all optical sensor terminals periodically for sensors.

- Sensor description**      A name for the sensor (such as the switchboard section it is monitoring) to aid in troubleshooting.
- Ignore sensor check errors**      The PGR-8800 will not report if a sensor is removed. Check this box to disable sensor check. The corresponding sensor-check LED will still flash if connected.
- Change configuration**      Once a sensor is connected to a terminal, the PGR-8800 will report an error if it is removed. If a sensor is removed, this allows the sensor expected status to be reset.

**NOTE:** Sensor status can also be reset by placing the PGR-8800 in service mode and then pressing the RESET button.

### Local Sensor

Local Sensor	
Sensor description	<input type="text" value="Local sensor"/> <a href="#">Undo</a> <a href="#">Reset</a>
Local sensor causes trip	<input type="checkbox"/> <a href="#">Undo</a> <a href="#">Reset</a>

The local sensor is located on the front of the PGR-8800 and is primarily intended for commissioning of sensors. The configuration software allows a 25-character description.

The local sensor can also be used to trip the circuit breaker if the checkbox is marked.

## 12.2.6 Current-Sensor Settings

General
Optical Sensors
Current Sensors
Inputs
Online Output
Service Output
Tripped Output
Trip Coil Output
Comms
Advanced
About

### Current Sensors

**Setup**

Rated nominal load current	100	A RMS on CT primary	<a href="#">Undo</a> <a href="#">Reset</a>
CT transformation ratio	100	A to 5 A RMS	<a href="#">Undo</a> <a href="#">Reset</a>
Current sensor mode	AC ▾		<a href="#">Undo</a> <a href="#">Reset</a>
Enable current inhibit	<input type="checkbox"/>		<a href="#">Undo</a> <a href="#">Reset</a>
Trip on Overcurrent 1	<input type="checkbox"/>		<a href="#">Undo</a> <a href="#">Reset</a>
Trip on Overcurrent 2	<input type="checkbox"/>		<a href="#">Undo</a> <a href="#">Reset</a>

Save All
Reset (This Tab)
Undo (This Tab)
Save and Exit
Exit

### Setup

The current sensors can be configured for use as current-supervised trip inhibit and/or overcurrent protection.

By default, overcurrent protection and current-supervised trip inhibit are disabled. The value of the rated-current set point will not affect the operation of the PGR-8800 until one of these functions is enabled using the checkboxes.

When using current sensors, the signal being applied to the sensors (ac or dc) must be defined. The module will automatically track the zero point if AC is selected.

The rated nominal load current is the typical current level that will be observed on the current sensor primary and is the reference for the Inhibit and Overcurrent functions.

The current sensor ratio must also be defined. The PGR-8800 only accepts current sensors with a 5-A-secondary current. The accuracy of the reading is 1 A (current-sensors-secondary current). Due to the fast reaction time of the PGR-8800 to an arc flash, it is important to set all levels and time delays with this in mind.



### Current-Supervised Trip Inhibit

Enable current inhibit	<input checked="" type="checkbox"/>	<a href="#">Undo</a> <a href="#">Reset</a>
Trip on Overcurrent 1	<input type="checkbox"/>	<a href="#">Undo</a> <a href="#">Reset</a>
Trip on Overcurrent 2	<input type="checkbox"/>	<a href="#">Undo</a> <a href="#">Reset</a>
Indicator blinks when above	<input type="text" value="100"/> % of rated current	<a href="#">Undo</a> <a href="#">Reset</a>

<b>Trip Inhibit</b>		
Inhibit function disables trips below	<input type="text" value="50"/> % of rated current	<a href="#">Undo</a> <a href="#">Reset</a>

The primary function of the current-sensor inputs is to provide current-supervised arc-flash protection. If light is detected by the optical sensors but the current is below the Trip Inhibit setting, the PGR-8800 will not trip. This value is adjustable from 10 to 1,000% of the rated nominal load current. This feature is disabled by default. See Section 6.

When Current Inhibit is enabled, the INHIBIT LED on the front of the PGR-8800 will be on when current is below the set point. When the current is above the set point, the INHIBIT LED will be off.

### Overcurrent Protection

Trip on Overcurrent 1	<input checked="" type="checkbox"/>	<a href="#">Undo</a> <a href="#">Reset</a>
Trip on Overcurrent 2	<input type="checkbox"/>	<a href="#">Undo</a> <a href="#">Reset</a>
Indicator blinks when above	<input type="text" value="100"/> % of rated current	<a href="#">Undo</a> <a href="#">Reset</a>

<b>Overcurrent 1 Protection</b>		
Trip on current above	<input type="text" value="150"/> % of rated current	<a href="#">Undo</a> <a href="#">Reset</a>
Time delay	<input type="text" value="500"/> ms	<a href="#">Undo</a> <a href="#">Reset</a>

*NOTE: See the documentation before using the Overcurrent functions in single phase systems.*

The PGR-8800 has two definite-time overcurrent set points which can be used for instantaneous, short-, and long-time overcurrent protection. This feature is disabled by default.

The current level required to trip is set as a percentage of the rated nominal load current. The overcurrent trip levels can be set from 150 to 1,000% and the time delay is adjustable from 1 to 20,000 milliseconds. See Section 6.

Overcurrent protection operates independently from arc-flash protection and the optical sensors.



## 12.2.7 Input Settings

General
Optical Sensors
Current Sensors
Inputs
Online Output
Service Output
Tripped Output
Trip Coil Output
Comms
Advanced
About

### Inputs

**Inhibit Inputs**

Function: Inhibit when low (switch closed) ▼ [Undo](#) [Reset](#)

**Trip Inputs**

Main function: Trip input ▼ [Undo](#) [Reset](#)

Function: Trip the output when low (switch closed) ▼ [Undo](#) [Reset](#)

Trip on this input can be inhibited  [Undo](#) [Reset](#)

**Reset Inputs**

Function: Reset when low (switch closed) ▼ [Undo](#) [Reset](#)

**Breaker Failure Options**

Detect clearing failure by trip input  [Undo](#) [Reset](#)

Detect clearing failure by current  [Undo](#) [Reset](#)

Save All
Reset (This Tab)
Undo (This Tab)
Save and Exit
Exit

By default, the digital inputs are considered active when connected to COM (terminal 45). Using the drop-down lists, the inputs can be disabled, circuit-check can be enabled (see Section 7) and the inputs can be configured to be inactive when connected to COM (inverted).

The Trip inputs can also be inhibited if enabled. Otherwise, a Trip input is allowed to occur regardless of the Inhibit Inputs function selection.

When the PGR-8800 sends a trip signal to the local circuit breaker, the status of the circuit breaker can be monitored using the Trip input. In the case of a local circuit breaker failure, the PGR-8800 can be configured to trip an upstream circuit breaker. See Appendix C.

The PGR-8800 relies on the circuit breaker to extinguish an arc flash. The PGR-8800 can be programmed to trip a secondary device further upstream if the local circuit breaker fails. Circuit-breaker failure is detected by connecting the auxiliary contact to the PGR-8800 Trip input or by measuring the current using the current sensors, or both.

## 12.2.8 Output Settings

### 12.2.8.1 Online Output

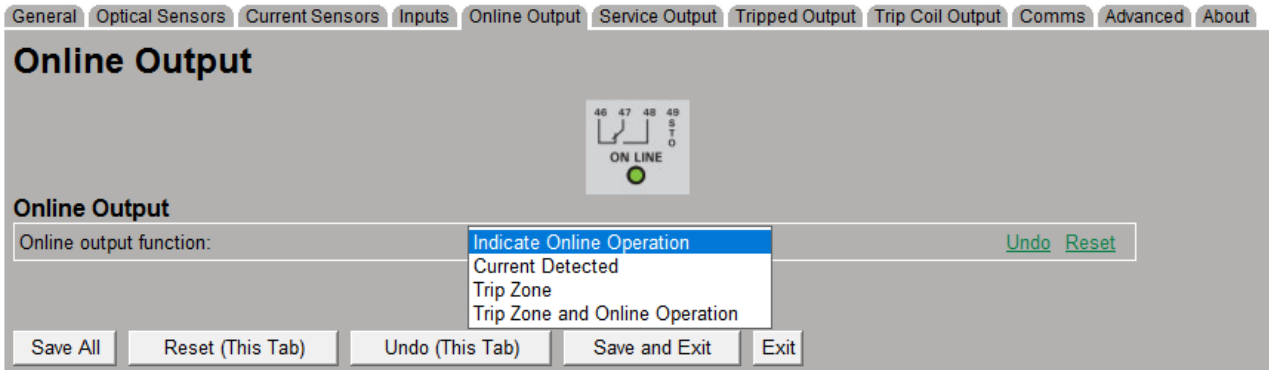

The screenshot shows the 'Online Output' configuration page. At the top, there is a navigation bar with tabs: General, Optical Sensors, Current Sensors, Inputs, Online Output (selected), Service Output, Tripped Output, Trip Coil Output, Comms, Advanced, and About. Below the navigation bar is the title 'Online Output' and a schematic diagram of the relay's output terminals (46, 47, 48, 49) with an 'ON LINE' indicator. The main configuration area is titled 'Online Output' and contains a dropdown menu for 'Online output function:'. The dropdown menu is open, showing the following options: 'Indicate Online Operation' (highlighted in blue), 'Current Detected', 'Trip Zone', and 'Trip Zone and Online Operation'. To the right of the dropdown are 'Undo' and 'Reset' links. At the bottom of the page are buttons for 'Save All', 'Reset (This Tab)', 'Undo (This Tab)', 'Save and Exit', and 'Exit'.

The Online output function can be configured in several ways. The default setting is Indicate Online Operation. See Section 8.1 for more details.

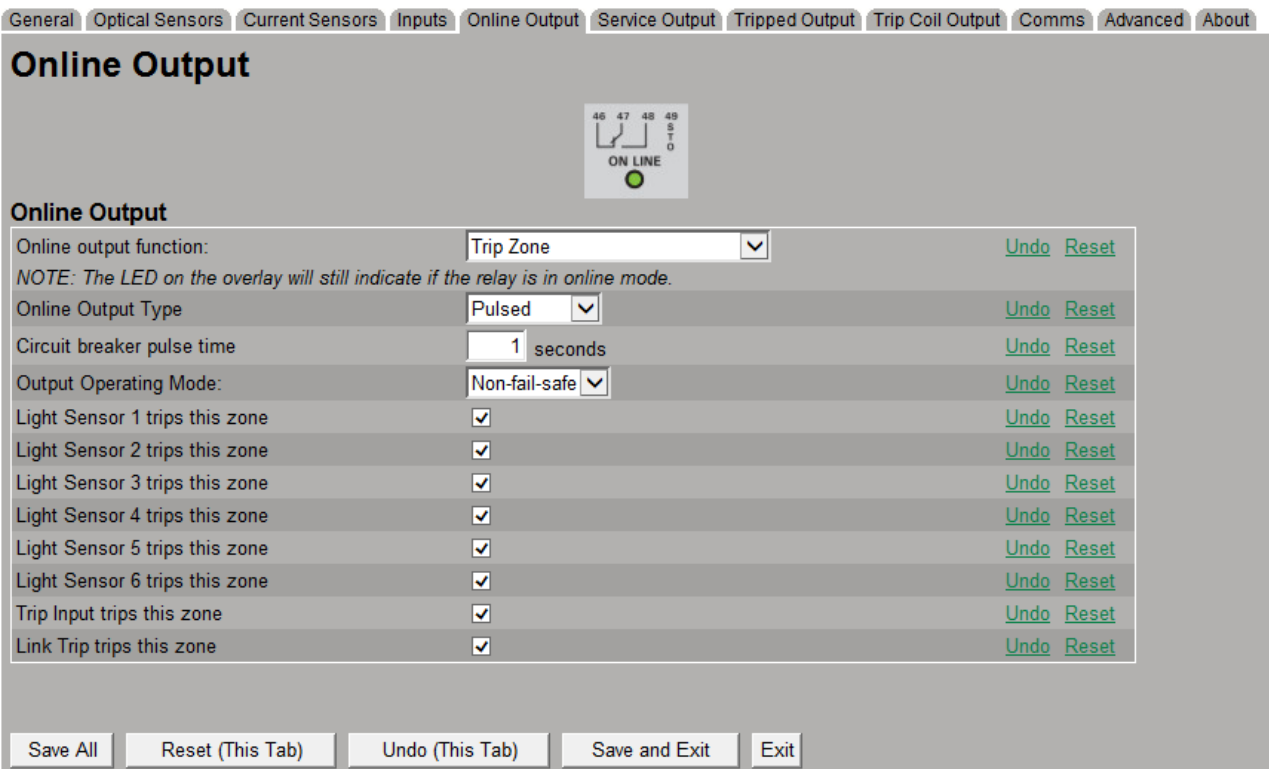

The screenshot shows the 'Online Output' configuration page with the 'Online output function' set to 'Trip Zone'. The page includes a navigation bar, a title, a schematic diagram, and a list of configuration options. The 'Online output function:' dropdown is set to 'Trip Zone' with 'Undo' and 'Reset' links. Below this is a note: 'NOTE: The LED on the overlay will still indicate if the relay is in online mode.' The 'Online Output Type' is set to 'Pulsed' with 'Undo' and 'Reset' links. The 'Circuit breaker pulse time' is set to '1 seconds' with 'Undo' and 'Reset' links. The 'Output Operating Mode' is set to 'Non-fail-safe' with 'Undo' and 'Reset' links. There are eight rows of checkboxes, each with 'Undo' and 'Reset' links: 'Light Sensor 1 trips this zone', 'Light Sensor 2 trips this zone', 'Light Sensor 3 trips this zone', 'Light Sensor 4 trips this zone', 'Light Sensor 5 trips this zone', 'Light Sensor 6 trips this zone', 'Trip Input trips this zone', and 'Link Trip trips this zone'. All checkboxes are checked. At the bottom are buttons for 'Save All', 'Reset (This Tab)', 'Undo (This Tab)', 'Save and Exit', and 'Exit'.

General Optical Sensors Current Sensors Inputs Online Output Service Output Tripped Output Trip Coil Output Comms Advanced About

### Online Output



#### Online Output

Online output function: Trip Zone [Undo](#) [Reset](#)

*NOTE: The LED on the overlay will still indicate if the relay is in online mode.*

Online Output Type: Continuous [Undo](#) [Reset](#)

Output Operating Mode: Non-fail-safe [Undo](#) [Reset](#)

Light Sensor 1 trips this zone	<input checked="" type="checkbox"/>	<a href="#">Undo</a> <a href="#">Reset</a>
Light Sensor 2 trips this zone	<input checked="" type="checkbox"/>	<a href="#">Undo</a> <a href="#">Reset</a>
Light Sensor 3 trips this zone	<input checked="" type="checkbox"/>	<a href="#">Undo</a> <a href="#">Reset</a>
Light Sensor 4 trips this zone	<input checked="" type="checkbox"/>	<a href="#">Undo</a> <a href="#">Reset</a>
Light Sensor 5 trips this zone	<input checked="" type="checkbox"/>	<a href="#">Undo</a> <a href="#">Reset</a>
Light Sensor 6 trips this zone	<input checked="" type="checkbox"/>	<a href="#">Undo</a> <a href="#">Reset</a>
Trip Input trips this zone	<input checked="" type="checkbox"/>	<a href="#">Undo</a> <a href="#">Reset</a>
Link Trip trips this zone	<input checked="" type="checkbox"/>	<a href="#">Undo</a> <a href="#">Reset</a>

Save All Reset (This Tab) Undo (This Tab) Save and Exit Exit

General Optical Sensors Current Sensors Inputs Online Output Service Output Tripped Output Trip Coil Output Comms Advanced About

### Online Output



#### Online Output

Online output function: Current Detected [Undo](#) [Reset](#)

**ERROR: Current Inhibit is not enabled. Enable in Current Sensors tab.**

*NOTE: The LED on the overlay will still indicate if the relay is in online mode.*

Output Operating Mode: Non-fail-safe [Undo](#) [Reset](#)

Save All Reset (This Tab) Undo (This Tab) Save and Exit Exit

## 12.2.8.2 Service Output

General Optical Sensors Current Sensors Inputs Online Output Service Output Tripped Output Trip Coil Output Comms Advanced About

### Service Output



#### Service Output

Service output function: Indicate Service mode [Undo](#) [Reset](#)

Follow trip coil output

Trip upstream breaker on clearing failure

Trip Zone

Current Detected

Save All Reset (This Tab) Undo (This Tab) Save and Exit Exit

The Service output function can be configured in several ways. See Section 8.2 for more details.

General Optical Sensors Current Sensors Inputs Online Output **Service Output** Tripped Output Trip Coil Output Comms Advanced About

## Service Output



**Service Output**

Service output function: Trip Zone [Undo](#) [Reset](#)

*NOTE: The LED on the overlay will still indicate if the relay is in service mode.*

Service Output Type: Pulsed [Undo](#) [Reset](#)

Circuit breaker pulse time: 1 seconds [Undo](#) [Reset](#)

Output Operating Mode: Non-fail-safe [Undo](#) [Reset](#)

Light Sensor 1 trips this zone	<input checked="" type="checkbox"/>	<a href="#">Undo</a> <a href="#">Reset</a>
Light Sensor 2 trips this zone	<input checked="" type="checkbox"/>	<a href="#">Undo</a> <a href="#">Reset</a>
Light Sensor 3 trips this zone	<input checked="" type="checkbox"/>	<a href="#">Undo</a> <a href="#">Reset</a>
Light Sensor 4 trips this zone	<input checked="" type="checkbox"/>	<a href="#">Undo</a> <a href="#">Reset</a>
Light Sensor 5 trips this zone	<input checked="" type="checkbox"/>	<a href="#">Undo</a> <a href="#">Reset</a>
Light Sensor 6 trips this zone	<input checked="" type="checkbox"/>	<a href="#">Undo</a> <a href="#">Reset</a>
Trip Input trips this zone	<input checked="" type="checkbox"/>	<a href="#">Undo</a> <a href="#">Reset</a>
Link Trip trips this zone	<input checked="" type="checkbox"/>	<a href="#">Undo</a> <a href="#">Reset</a>

Save All Reset (This Tab) Undo (This Tab) Save and Exit Exit

General Optical Sensors Current Sensors Inputs Online Output **Service Output** Tripped Output Trip Coil Output Comms Advanced About

## Service Output



**Service Output**

Service output function: Trip Zone [Undo](#) [Reset](#)

*NOTE: The LED on the overlay will still indicate if the relay is in service mode.*

Service Output Type: Continuous [Undo](#) [Reset](#)

Output Operating Mode: Non-fail-safe [Undo](#) [Reset](#)

Light Sensor 1 trips this zone	<input checked="" type="checkbox"/>	<a href="#">Undo</a> <a href="#">Reset</a>
Light Sensor 2 trips this zone	<input checked="" type="checkbox"/>	<a href="#">Undo</a> <a href="#">Reset</a>
Light Sensor 3 trips this zone	<input checked="" type="checkbox"/>	<a href="#">Undo</a> <a href="#">Reset</a>
Light Sensor 4 trips this zone	<input checked="" type="checkbox"/>	<a href="#">Undo</a> <a href="#">Reset</a>
Light Sensor 5 trips this zone	<input checked="" type="checkbox"/>	<a href="#">Undo</a> <a href="#">Reset</a>
Light Sensor 6 trips this zone	<input checked="" type="checkbox"/>	<a href="#">Undo</a> <a href="#">Reset</a>
Trip Input trips this zone	<input checked="" type="checkbox"/>	<a href="#">Undo</a> <a href="#">Reset</a>
Link Trip trips this zone	<input checked="" type="checkbox"/>	<a href="#">Undo</a> <a href="#">Reset</a>

Save All Reset (This Tab) Undo (This Tab) Save and Exit Exit

General Optical Sensors Current Sensors Inputs Online Output **Service Output** Tripped Output Trip Coil Output Comms Advanced About

### Service Output



**Service Output**

Service output function:  [Undo](#) [Reset](#)

*ERROR: Current Inhibit is not enabled. Enable in Current Sensors tab.*

*NOTE: The LED on the overlay will still indicate if the relay is in service mode.*

Output Operating Mode:  [Undo](#) [Reset](#)

Save All Reset (This Tab) Undo (This Tab) Save and Exit Exit

### 12.2.8.3 Tripped Output

General Optical Sensors Current Sensors Inputs Online Output Service Output **Tripped Output** Trip Coil Output Comms Advanced About

### Tripped Output



**Tripped Output**

Tripped output function:  [Undo](#) [Reset](#)

*NOTE: The LED on the overlay will still indicate if the*

- Indicate that the unit tripped
- Follow trip coil output
- Trip upstream breaker on clearing failure
- User-defined pulse on trip
- Trip Zone
- Current Detected

Save All Reset (This Tab) Undo (This Tab) Save and Exit Exit

The Tripped output function can be configured in several ways. See Section 8.3 for more details.

General Optical Sensors Current Sensors Inputs Online Output Service Output **Tripped Output** Trip Coil Output Comms Advanced About

## Tripped Output



### Tripped Output

Tripped output function:	Trip Zone	<a href="#">Undo</a> <a href="#">Reset</a>
<i>NOTE: The LED on the overlay will still indicate if the relay has tripped.</i>		
Tripped Output Type	Pulsed	<a href="#">Undo</a> <a href="#">Reset</a>
Circuit breaker pulse time	1 seconds	<a href="#">Undo</a> <a href="#">Reset</a>
Output Operating Mode:	Non-fail-safe	<a href="#">Undo</a> <a href="#">Reset</a>
Light Sensor 1 trips this zone	<input checked="" type="checkbox"/>	<a href="#">Undo</a> <a href="#">Reset</a>
Light Sensor 2 trips this zone	<input checked="" type="checkbox"/>	<a href="#">Undo</a> <a href="#">Reset</a>
Light Sensor 3 trips this zone	<input checked="" type="checkbox"/>	<a href="#">Undo</a> <a href="#">Reset</a>
Light Sensor 4 trips this zone	<input checked="" type="checkbox"/>	<a href="#">Undo</a> <a href="#">Reset</a>
Light Sensor 5 trips this zone	<input checked="" type="checkbox"/>	<a href="#">Undo</a> <a href="#">Reset</a>
Light Sensor 6 trips this zone	<input checked="" type="checkbox"/>	<a href="#">Undo</a> <a href="#">Reset</a>
Trip Input trips this zone	<input checked="" type="checkbox"/>	<a href="#">Undo</a> <a href="#">Reset</a>
Link Trip trips this zone	<input checked="" type="checkbox"/>	<a href="#">Undo</a> <a href="#">Reset</a>

Save All Reset (This Tab) Undo (This Tab) Save and Exit Exit

General Optical Sensors Current Sensors Inputs Online Output Service Output **Tripped Output** Trip Coil Output Comms Advanced About

## Tripped Output



### Tripped Output

Tripped output function:	Trip Zone	<a href="#">Undo</a> <a href="#">Reset</a>
<i>NOTE: The LED on the overlay will still indicate if the relay has tripped.</i>		
Tripped Output Type	Continuous	<a href="#">Undo</a> <a href="#">Reset</a>
Output Operating Mode:	Non-fail-safe	<a href="#">Undo</a> <a href="#">Reset</a>
Light Sensor 1 trips this zone	<input checked="" type="checkbox"/>	<a href="#">Undo</a> <a href="#">Reset</a>
Light Sensor 2 trips this zone	<input checked="" type="checkbox"/>	<a href="#">Undo</a> <a href="#">Reset</a>
Light Sensor 3 trips this zone	<input checked="" type="checkbox"/>	<a href="#">Undo</a> <a href="#">Reset</a>
Light Sensor 4 trips this zone	<input checked="" type="checkbox"/>	<a href="#">Undo</a> <a href="#">Reset</a>
Light Sensor 5 trips this zone	<input checked="" type="checkbox"/>	<a href="#">Undo</a> <a href="#">Reset</a>
Light Sensor 6 trips this zone	<input checked="" type="checkbox"/>	<a href="#">Undo</a> <a href="#">Reset</a>
Trip Input trips this zone	<input checked="" type="checkbox"/>	<a href="#">Undo</a> <a href="#">Reset</a>
Link Trip trips this zone	<input checked="" type="checkbox"/>	<a href="#">Undo</a> <a href="#">Reset</a>

Save All Reset (This Tab) Undo (This Tab) Save and Exit Exit

General
Optical Sensors
Current Sensors
Inputs
Online Output
Service Output
Tripped Output
Trip Coil Output
Comms
Advanced
About

## Tripped Output



**Tripped Output**

Tripped output function: Current Detected [Undo](#) [Reset](#)

**ERROR: Current Inhibit is not enabled. Enable in Current Sensors tab.**

NOTE: The LED on the overlay will still indicate if the relay has tripped.

Output Operating Mode: Non-fail-safe [Undo](#) [Reset](#)

Save All
Reset (This Tab)
Undo (This Tab)
Save and Exit
Exit

### 12.2.8.4 Trip Coil Output

General
Optical Sensors
Current Sensors
Inputs
Online Output
Service Output
Tripped Output
Trip Coil Output
Comms
Advanced
About

## Trip Coil Output



**Trip Coil Output**

Trip Coil output function: Indicate that the unit tripped [Undo](#) [Reset](#)

Circuit breaker type: Shunt coil (trips when powered) [Undo](#) [Reset](#)

Trip Coil Output Type: Pulsed [Undo](#) [Reset](#)

WARNING: 20 A for 2 s, 10 A for 5 s, 750 mA continuous rating.

Circuit breaker pulse time: 1 seconds [Undo](#) [Reset](#)

Report an error if trip coil is not detected:  [Undo](#) [Reset](#)

Save All
Reset (This Tab)
Undo (This Tab)
Save and Exit
Exit

The Trip Coil Output can be configured to operate a shunt or an undervoltage circuit breaker. In shunt mode, power is required to cause the circuit breaker to trip. Most installations will use this type of circuit breaker because the trip times are typically faster than undervoltage circuit breakers. However, the undervoltage circuit breaker has the advantage of tripping when supply voltage is lost, making it a fail-safe device.

The amount of time that supply voltage will be applied to a shunt circuit breaker or removed from an undervoltage circuit breaker is defined by the circuit-breaker pulse time and can be set from 1 to 5 s.

An external trip voltage is applied to one side of the Trip Coil output. If voltage is not present while in shunt mode, the PGR-8800 will deactivate the ONLINE output if configured, and flash the Trip Coil red LED. This feature can be disabled by deselecting the Report an error if trip coil is not detected checkbox.

For more information on trip-coil operation, see Section 8.4.

By default, the PGR-8800 does not send a trip signal when in service mode because this mode can be used for verifying sensor operation. Service-mode tripping can be selected by the Trip in service

mode checkbox. There is no indication of this setting on the front panel, so work procedures should make a note of this.

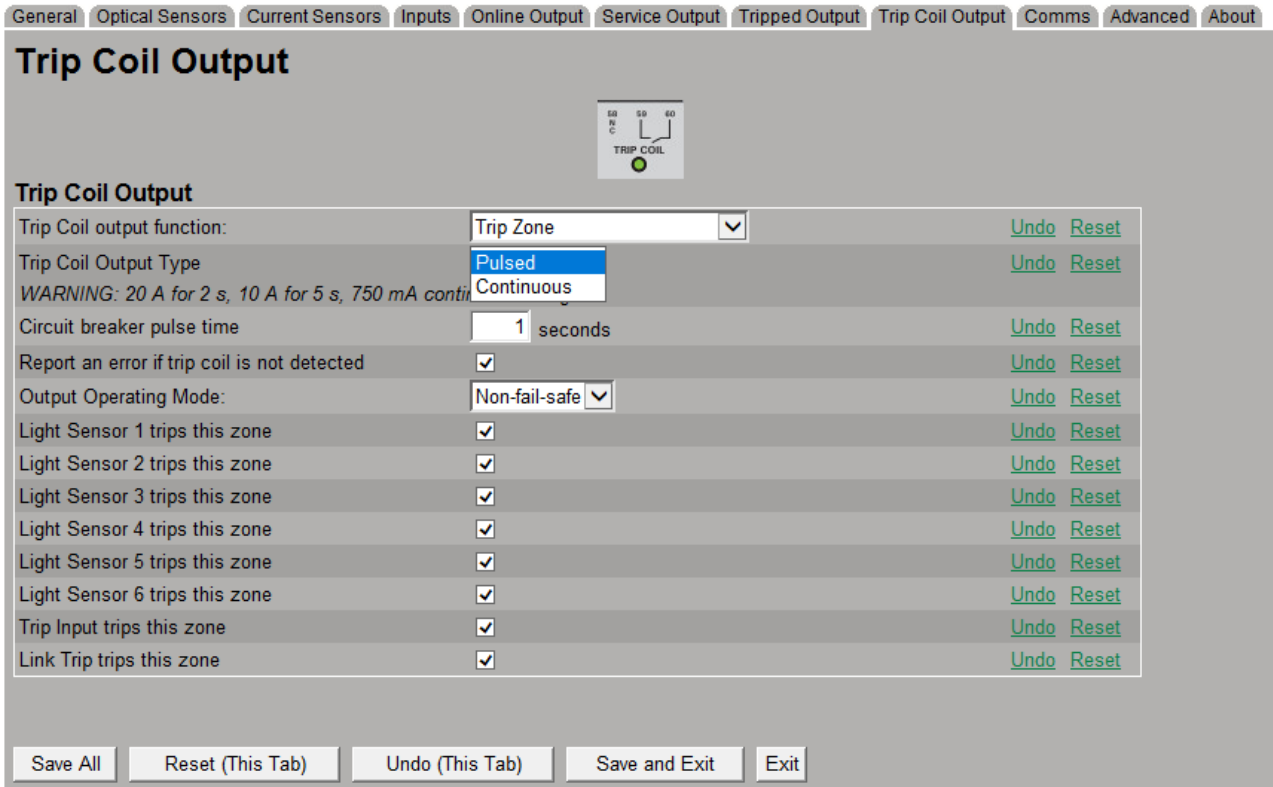

**Trip Coil Output**

Trip Coil output function: Trip Zone [Undo](#) [Reset](#)

Trip Coil Output Type: Pulsed [Undo](#) [Reset](#)  
WARNING: 20 A for 2 s, 10 A for 5 s, 750 mA continuous Continuous

Circuit breaker pulse time: 1 seconds [Undo](#) [Reset](#)

Report an error if trip coil is not detected:  [Undo](#) [Reset](#)

Output Operating Mode: Non-fail-safe [Undo](#) [Reset](#)

Light Sensor 1 trips this zone:  [Undo](#) [Reset](#)

Light Sensor 2 trips this zone:  [Undo](#) [Reset](#)

Light Sensor 3 trips this zone:  [Undo](#) [Reset](#)

Light Sensor 4 trips this zone:  [Undo](#) [Reset](#)

Light Sensor 5 trips this zone:  [Undo](#) [Reset](#)

Light Sensor 6 trips this zone:  [Undo](#) [Reset](#)

Trip Input trips this zone:  [Undo](#) [Reset](#)

Link Trip trips this zone:  [Undo](#) [Reset](#)

Save All   Reset (This Tab)   Undo (This Tab)   Save and Exit   Exit

When the Trip Coil output function is set to Trip Zone, only the selected Light Sensors will trip this zone.

The Trip Coil Output Type can be set to Pulsed or Continuous.

The Output Operating Mode can be set to Fail-safe or Non-fail-safe mode.



General Optical Sensors Current Sensors Inputs Online Output Service Output Tripped Output Trip Coil Output Comms Advanced About

## Trip Coil Output



### Trip Coil Output

Trip Coil output function:	Trip Zone	<a href="#">Undo</a> <a href="#">Reset</a>
Trip Coil Output Type	Continuous	<a href="#">Undo</a> <a href="#">Reset</a>
<i>WARNING: 20 A for 2 s, 10 A for 5 s, 750 mA continuous rating.</i>		
Report an error if trip coil is not detected	<input checked="" type="checkbox"/>	<a href="#">Undo</a> <a href="#">Reset</a>
Output Operating Mode:	Non-fail-safe	<a href="#">Undo</a> <a href="#">Reset</a>
Light Sensor 1 trips this zone	Fail-safe	<a href="#">Undo</a> <a href="#">Reset</a>
Light Sensor 2 trips this zone	<input checked="" type="checkbox"/>	<a href="#">Undo</a> <a href="#">Reset</a>
Light Sensor 3 trips this zone	<input checked="" type="checkbox"/>	<a href="#">Undo</a> <a href="#">Reset</a>
Light Sensor 4 trips this zone	<input checked="" type="checkbox"/>	<a href="#">Undo</a> <a href="#">Reset</a>
Light Sensor 5 trips this zone	<input checked="" type="checkbox"/>	<a href="#">Undo</a> <a href="#">Reset</a>
Light Sensor 6 trips this zone	<input checked="" type="checkbox"/>	<a href="#">Undo</a> <a href="#">Reset</a>
Trip Input trips this zone	<input checked="" type="checkbox"/>	<a href="#">Undo</a> <a href="#">Reset</a>
Link Trip trips this zone	<input checked="" type="checkbox"/>	<a href="#">Undo</a> <a href="#">Reset</a>

Save All Reset (This Tab) Undo (This Tab) Save and Exit Exit

General Optical Sensors Current Sensors Inputs Online Output Service Output Tripped Output Trip Coil Output Comms Advanced About

## Trip Coil Output



### Trip Coil Output

Trip Coil output function:	Current Detected	<a href="#">Undo</a> <a href="#">Reset</a>
<i>ERROR: Current Inhibit is not enabled. Enable in Current Sensors tab.</i>		
Output Operating Mode:	Fail-safe	<a href="#">Undo</a> <a href="#">Reset</a>

Save All Reset (This Tab) Undo (This Tab) Save and Exit Exit

## 12.2.9 Communications Settings

### Link Interface

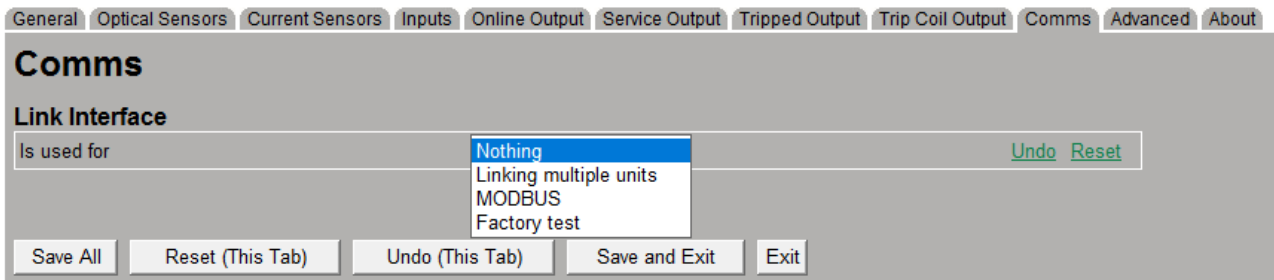

The Link input on the PGR-8800 (terminals 37, 38) is a multi-function communications port. The port is disabled by default and can be configured as follows through the Link Interface drop-down list:

Nothing	Disable communications port.
Link multiple units	Connect up to four PGR-8800 relays.
Modbus	Enable remote communication using the Modbus protocol.
Factory test	Not intended for customer use.

Selecting each option in the drop-down list will reveal further options.

## Link Configuration

General
Optical Sensors
Current Sensors
Inputs
Online Output
Service Output
Tripped Output
Trip Coil Output
Comms
Advanced
About

### Comms

#### Link Interface

Is used for  [Undo](#) [Reset](#)

*NOTE: Waveform capture cannot be used when the Link feature is selected.*

*NOTE: Changes to this parameter will reboot the unit to complete the change.*

#### Link Configuration

Unit address	<input type="text" value="1"/>	Must be unique, lowest must be 1	<a href="#">Undo</a> <a href="#">Reset</a>
Number of linked units in the system	<input type="text" value="1"/>	Report an error if any unit is missing.	<a href="#">Undo</a> <a href="#">Reset</a>
Send Link alarm signal on	<input type="text" value="Trip"/>		<a href="#">Undo</a> <a href="#">Reset</a>
Received Link alarm signal trips this unit	<input checked="" type="checkbox"/>		<a href="#">Undo</a> <a href="#">Reset</a>
Link sends and receives the user interface	<input checked="" type="checkbox"/>		<a href="#">Undo</a> <a href="#">Reset</a>
Link sends and receives errors	<input checked="" type="checkbox"/>		<a href="#">Undo</a> <a href="#">Reset</a>

Save All
Reset (This Tab)
Undo (This Tab)
Save and Exit
Exit

Up to four PGR-8800's can be linked in this mode, but each must be given a unique Unit address and the total Number of linked units in the system must be configured in all linked units.

The PGR-8800 can be programmed to send an alarm signal over the link interface:

Never	The PGR-8800 will receive alarm signals but not send them.
Light above threshold	An alarm signal will be sent when light is above the trip level regardless of the local inhibit status.
Trip	An alarm signal will only be sent when all local conditions such as light level and inhibit are satisfied.
Clearing failure	The PGR-8800 will send an alarm signal when the local circuit breaker does not trip.

### Received Link alarm signal trips this unit

If selected, this option will allow the module to receive a Link alarm sent from another unit, and will trip the module. If Current Inhibit is enabled or the Trip Inhibit input is activated on this unit, the trip will be inhibited until the current reaches the selected threshold or the Trip Inhibit input is cleared.

### Link sends and receives the user interface

This option will allow the module to send and receive button presses. Pressing RESET on one module will reset all link-enabled modules with this option selected. Modules will also change mode together. This does not influence the Trip and Inhibit terminal inputs.

### Link sends and receives errors

This option shares errors such as sensor-check failure or no voltage on the TRIP COIL to all the linked units. As a result, an error on one module will change the online mode on all link-enabled modules.

The PGR-8800 can be configured to share light-sensor information. Although a current-inhibited PGR-8800 detecting excess light will not trip, it will trip a remote PGR-8800 that is not inhibited by sharing light intensity. See Section 11 for more information on linking multiple units.

## Modbus Configuration

General
Optical Sensors
Current Sensors
Inputs
Online Output
Service Output
Tripped Output
Trip Coil Output
Comms
Advanced
About

### Comms

**Link Interface**

Is used for MODBUS [Undo](#) [Reset](#)

NOTE: Changes to this parameter will reboot the unit to complete the change.

**MODBUS Configuration**

Unit address	1	<a href="#">Undo</a> <a href="#">Reset</a>
Baud rate	19200	<a href="#">Undo</a> <a href="#">Reset</a>
Parity	Even	<a href="#">Undo</a> <a href="#">Reset</a>
Stopbits	Auto	<a href="#">Undo</a> <a href="#">Reset</a>
Allow writes via MODBUS	<input checked="" type="checkbox"/>	<a href="#">Undo</a> <a href="#">Reset</a>

Save All
Reset (This Tab)
Undo (This Tab)
Save and Exit
Exit

The Modbus device address, baud rate, and parity must be configured on the device with the Configuration Software.

### Default Configuration

Device address	1
Baudrate	19200
Parity	Even
Number of start bits	8
Number of stop bits (controlled by parity selection)	
Even Parity	1
Odd Parity	1
None	2
Auto	2 (None) or 1 (Even or Odd)

Allow writes via MODBUS is disabled by default.

### Network Termination

Since the PGR-8800 Modbus interface shares the Link interface, the network is already terminated internally. This limits the number of units which can be connected, and the maximum length of the connection. See Section 11.3.

See Appendices A and B for the Modbus Protocol description and database table.

## 12.2.10 Advanced Settings

General
Optical Sensors
Current Sensors
Inputs
Online Output
Service Output
Tripped Output
Trip Coil Output
Comms
Advanced
About

### Advanced

#### Service Mode Options

Return to ONLINE mode when USB is unplugged	<input type="checkbox"/>	<a href="#">Undo</a> <a href="#">Reset</a>
Trip in Service mode	<input type="checkbox"/>	<a href="#">Undo</a> <a href="#">Reset</a>

#### Logging

Enable data logging	<input checked="" type="checkbox"/>	<a href="#">Undo</a> <a href="#">Reset</a>
Enable waveform capture	<input type="checkbox"/>	<a href="#">Undo</a> <a href="#">Reset</a>

*NOTE: If units trip their own power supply, loss of power may occur before all information is written to the datalog. UPS or a backup power source will ensure all datalog entries are recorded after a trip event.*

#### Internal Drives

Reset configuration drive to factory default	<input type="checkbox"/>	<a href="#">Undo</a> <a href="#">Reset</a>
Reset log drive to factory default	<input type="checkbox"/>	<a href="#">Undo</a> <a href="#">Reset</a>

#### Configuration

Reset configuration to factory defaults	<input type="checkbox"/>	<a href="#">Undo</a> <a href="#">Reset</a>
---	--------------------------	--

Save All

Reset (This Tab)

Undo (This Tab)

Save and Exit

Exit

### Service Mode Options

By default, the PGR-8800 will not return to ONLINE mode when a USB connection is removed. Starting with v1.03.16, the PGR-8800 can automatically return to ONLINE mode if selected.

A trip can also occur when in Service mode if selected.

### Logging

The data logging feature is enabled by default (v1.03.16 or newer). Waveform capture can also be enabled. If the PGR-8800 will be connected in an application where tripping results in a loss of supply power, use of a backup battery supply is recommended but not required when using data logging. See Section 12.3.

### Internal Drives & Configuration

In addition to the hardware reset procedures outlined in Section 10, the configuration software allows for partial reset of certain modules and configuration. Every parameter can be individually reset by using the Reset button associated with it (see Section 12.2.2).

Resetting the configuration drive will retain all settings but any files stored on the drive will be lost. Resetting the log drive will result in a loss of any logged events and stored data on the log drive.

By using the Reset configuration to factory defaults checkbox, all configuration settings can be restored to their default values.

### 12.2.11 About Tab

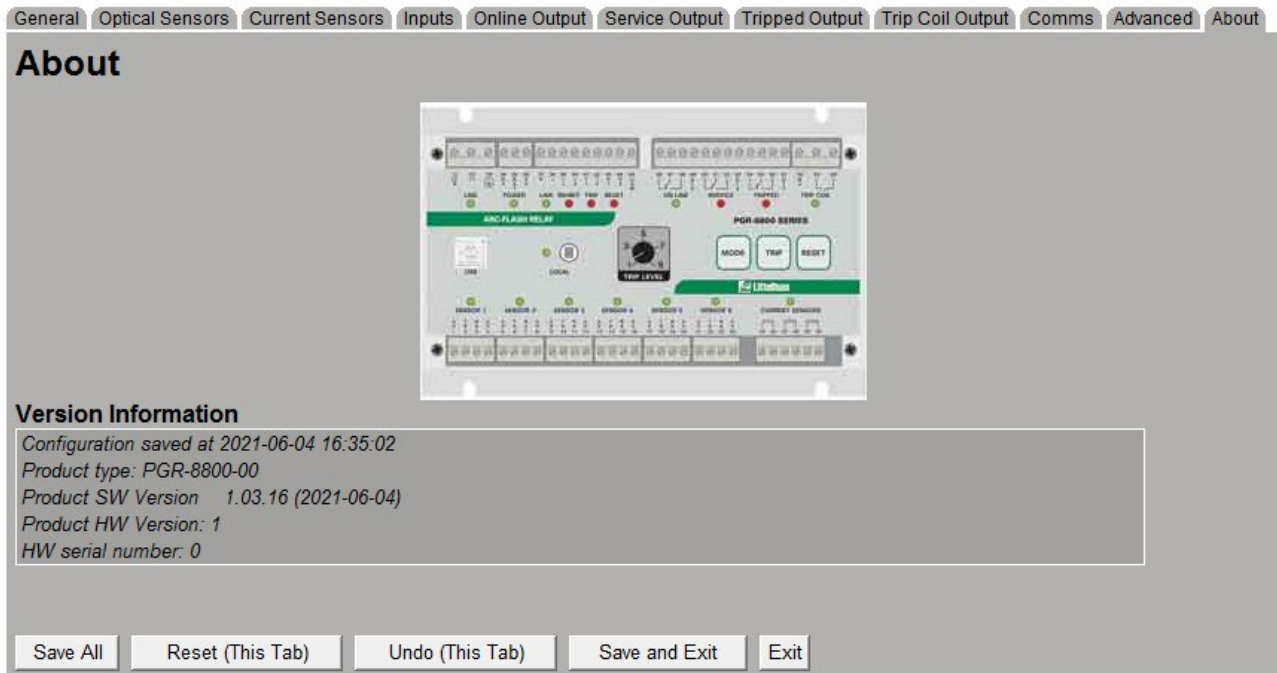

The About tab displays general information about the PGR-8800 such as the last time the configuration was saved, the firmware revision number, hardware revision number, and serial number.

### 12.3 Data Log Drive

The PGR-8800 can log all significant events including trips, errors and button presses. Data logging is enabled by default (v1.03.16 or newer). See Section 12.2.10.

Once enabled, the raw data is logged in a plain text file on the log drive. This file can be viewed in any text editor or in the included log.hta log reader. Log.hta displays the data log in a simplified format.



## Log Viewer

Logfile: log.txt

System rebooted!

```
2012-08-14T08:43:01 PGR-8800-00 rebooting. Reason [Power-up]
2012-08-14T08:43:01 MD5 hash of internal flash @ startup [9D 2F B8 4C 3D 59 29 78 8A 05 31 22 DB CE 47 7A]
2012-08-14T08:43:01 MD5 hash @ in protected store [9D 2F B8 4C 3D 59 29 78 8A 05 31 22 DB CE 47 7A]
2012-08-14T08:43:04 Booted without information on sensor configuration - will have to check connected sensors...
2012-08-14T08:43:04 Sensors autoconfiguration
2012-08-14T08:43:04 Reset [BOOL_SENSOR_1_IGNORE_CC]
2012-08-14T08:43:04 Reset [BOOL_SENSOR_2_IGNORE_CC]
2012-08-14T08:43:04 Reset [BOOL_SENSOR_3_IGNORE_CC]
2012-08-14T08:43:04 Reset [BOOL_SENSOR_4_IGNORE_CC]
2012-08-14T08:43:04 Reset [BOOL_SENSOR_5_IGNORE_CC]
2012-08-14T08:43:04 Reset [BOOL_SENSOR_6_IGNORE_CC]
2012-08-14T08:43:04 Error: IGBT unpowered!
2012-08-14T08:43:13 Sensor 1 found in circuit check
2012-08-14T08:43:13 Setting [INT_SENSOR_2_MODE] = [0000]
2012-08-14T08:43:13 Setting [INT_SENSOR_3_MODE] = [0000]
2012-08-14T08:43:13 Setting [INT_SENSOR_4_MODE] = [0000]
2012-08-14T08:43:13 Setting [INT_SENSOR_5_MODE] = [0000]
2012-08-14T08:43:13 Setting [INT_SENSOR_6_MODE] = [0000]
2012-08-14T08:43:14 Sensor 2 found in circuit check
2012-08-14T08:43:14 Setting [INT_SENSOR_2_MODE] = [0002]
2012-08-14T08:43:14 Sensor 3 found in circuit check
2012-08-14T08:43:14 Setting [INT_SENSOR_3_MODE] = [0002]
2012-08-14T08:43:14 Sensor 4 found in circuit check
2012-08-14T08:43:14 Setting [INT_SENSOR_4_MODE] = [0002]
2012-08-14T08:20:12-08-15T08:50:29 USB cable inserted
2012-08-15T08:50:30 Entering test mode (USB active)
```

## 12.4 Firmware Upgrade

**NOTE:** The PGR-8800 will restart during the firmware upgrade process. Ensure the equipment is in a safe state prior to starting the upgrade process. Do not interrupt the firmware upgrade process.

Product information, including hardware and firmware details, can be reviewed in the About tab as shown in Section 12.2.11.

Follow the procedure below to perform a firmware upgrade:

1. Contact Littelfuse at [relays@littelfuse.com](mailto:relays@littelfuse.com) to obtain the newest firmware file.
2. Connect the PGR-8800 to a computer using a USB cable. See Section 12.1.
3. Copy the PGR-8800.bin and PGR-8800.md5 files to the PGR-8800 Log drive.
4. Disconnect the USB cable. The firmware upgrade will begin. Progress will be shown on the front panel as progressively-lit green sensor LED's, starting from Sensor 1 to Sensor 6. The firmware upgrade can take up to 150 seconds.
5. The PGR-8800 will restart when the firmware upgrade has been completed.
6. Close the Configuration Software screen (HTA file).
7. Reconnect the PGR-8800 to the computer as in Step 2.
8. Confirm that the firmware revision shown in the About tab is correct.



## 13 COMMISSIONING

Even without configuration, the PGR-8800 will work using the factory default settings. See Section 12.2.3. It will always trip if a sensor input exceeds the Trip Level setting, even if the circuit check is falsely reporting a cable to be broken. However, we recommend doing a few simple tests on the sensors to ensure that problems on the sensors or cabling will be detected and reported.

The PGR-8800 will detect sensors on power up and report if they disappear, but in most installations it is advantageous to store the sensor configuration permanently. This is easily done by configuring the installed sensors either via USB as shown above or with the method described below.

### 13.1 Configuration of Installed Sensors

1. Press MODE to switch to service mode (SERVICE LED will be solid red).
2. Press and hold RESET for a few seconds to start the test sequence.
3. The LED's for sensors 1-6 will flash for 10 seconds while the system tests the optical sensors. This clears the sensor configuration<sup>1</sup>.
4. Move a light source of at least 100 lumen (e.g. 300 W halogen lamp) towards the local sensor until the LOCAL LED turns off. When using fiber sensors, a photo flash with a guide number of 15 m (49 ft) or larger can be used. See Section 15 for ordering information.
5. Observe that all connected sensor LED's are flashing. Move the light source towards each sensor until its internal LED turns off. This should happen at approximately the same distance at which was used before the local sensor reacted. The PGR-8800 LED associated with the sensor will change to solid green at the same time.
6. Return to the central unit and confirm that all LED's for connected sensors are showing a solid green LED. Illuminate the local sensor again to store the results.
7. The system will now flash green on all sensors briefly, store the results in non-volatile memory, and return to service mode. Sensor errors that may occur when the supply voltage is cycled can now be detected.
8. Press MODE to switch back to online mode. The sensors are now configured and the system will alarm if a sensor malfunctions.

### 13.2 Testing the Sensors

1. Press MODE to switch to service mode (SERVICE LED will be solid red).
2. Confirm that there is a solid PGR-8800 green LED for each connected optical sensor. This confirms that sensors are connected and healthy.
3. Confirm that a short red flashing light occurs periodically in each sensor. This indicates that the sensor circuit is being checked.
4. Point a light source at a sensor and check that the LED on the sensor and the unit begin to flash red continuously. On the first sensor tested, the TRIPPED LED will also turn on until the RESET button is pushed.

---

<sup>1</sup> If something is not functioning properly during the test, it can be cancelled by pressing RESET at any time. Reverting back to the previous configuration requires a power cycle of the unit.

5. Repeat step 4 for the remaining sensors.
6. Confirm that all LED's at connected sensors are flashing red. Press the RESET button.
7. Press MODE to switch back to online mode (ONLINE LED will be solid green and SERVICE LED will be off).

The test can be cancelled at any time by pressing MODE, to return to online mode.

### **13.3 Testing the Trip Coil**

1. Ensure that the system is ready for testing. The TRIP COIL output will be tripped during this procedure.
2. Press MODE to switch to service mode (SERVICE LED will be solid red).
3. Press and hold TRIP for a few seconds to activate the TRIP COIL output.
4. Observe that the connected trip coil operates. The output will reset itself after the configured pulse time, one second by default.
5. Press RESET. Reset the tripping device if necessary.
6. Press MODE to switch back to online mode (ONLINE LED will be solid green and SERVICE LED will be off).

### **13.4 Full Operation Test (Online)**

1. Make sure that the system is ready for test. The TRIP COIL output will be tripped during this procedure.
2. If necessary, press MODE to switch to online mode (ONLINE LED will be solid green).
3. Confirm that there is a solid PGR-8800 green LED for each connected optical sensor. This confirms that sensors are connected and healthy.
4. Confirm that a short red flashing light occurs periodically in each sensor. This indicates that the sensor circuit is being checked.
5. Move a light source towards the local sensor and confirm that it starts flashing.
6. Move a light source towards an external sensor. The SENSOR LED will start flashing green when the light intensity is approaching the Trip Level.
7. Continue to move a light source closer to the sensor. Confirm that the TRIP COIL output trips and that the LED's of the TRIP COIL and sensor change to flashing red.
8. Press RESET. Reset the tripping device if necessary.
9. Repeat steps 6 to 8 for the remaining sensors.

### **13.5 Light Sensitivity Adjustment**

1. Adjust the TRIP LEVEL dial; lower numbers result in higher sensitivity and greater detection range.

### **13.6 Fiber-Optic Sensor Adjustment**

The sensor is calibrated at the factory for 60 cm (24") of fiber in each monitored compartment. When using a fiber-optic sensor in compartments with less than 60 cm (24") of fiber, the sensitivity may have to be adjusted. The sensor is unable to differentiate between 10,000 lux on 60 cm (24") of fiber and 30,000 lux on 20 cm (8") of fiber – the same amount of light is transmitted through the fiber to the receiver. To achieve the desired sensitivity, the receiver (with the black thumb nut) must be adjusted.

#### **13.6.1 Sensor Adjustment for a Fiber Length other than 60 cm (24")**

To adjust for fiber length, a powerful light source of at least 100 lumen (e.g. 300 W halogen lamp) is required. In some cases, a photo flash with a guide number of 15 m (49 ft) or larger can be used. Use the following procedure to calibrate the sensor:

1. Switch the PGR-8800 to service mode by pressing the MODE button. The red SERVICE LED will light.
2. Adjust the TRIP LEVEL setting to 1 on the PGR-8800.
3. Slowly move the lamp towards the local sensor on the front of the PGR-8800.
4. Note the distance from the lamp to the sensor when the LOCAL LED starts blinking.
5. Adjust the receiver (black thumb nut) sensitivity level to the minimum by turning the small metal screw clockwise until it begins to click. This may be too low to detect the sensor-check signal and may cause the related LED on the relay to flash red.
6. Place the lamp facing the fiber in the compartment closest to the transmitter end (white thumb nut) of the fiber at the distance observed in step 4. This allows for loss along the full length of the fiber.
7. Slowly turn the metal screw on the receiver counter-clockwise until the PGR-8800 sensor-indicator LED for that sensor changes to red. If the LED was already flashing red in step 5, it should change to green first.
8. Adjust the TRIP LEVEL setting back to the desired position.

### **13.6.2 Sensor Adjustment in Small Compartments**

If the fiber-optic sensor is used in multiple compartments of varying size, the sensor must be calibrated to the compartment with the least fiber. If the lamp cannot be placed far enough away in the compartment to follow the procedure in Section 13.6.1, the sensitivity-adjustment procedure can be modified as follows:

1. Switch the PGR-8800 to service mode by pressing the MODE button. The red SERVICE LED will light.
2. In the compartment with the shortest fiber, measure the distance from the fiber to the lamp when the lamp is placed at the point in the compartment where it is furthest away.
3. Set the TRIP LEVEL to 9 on the PGR-8800.
4. Place the lamp facing the local sensor on the PGR-8800 at the same distance as measured in step 2.
5. Turn the TRIP LEVEL dial on the PGR-8800 counter clockwise until the LOCAL LED starts blinking.
6. Adjust the receiver (black thumb nut) sensitivity level to minimum by turning the small metal screw clockwise until it begins to click. This may be too low to detect the sensor-check signal and may cause the related LED on the relay to flash red.
7. Place the lamp in the compartment closest to the transmitter end (white thumb nut) of the fiber at the distance observed in step 2. This allows for loss along the full length of the fiber.
8. Slowly turn the metal screw on the receiver counter-clockwise until the PGR-8800 sensor-indicator LED for that sensor changes to red. If the LED was already flashing red in step 6, it should change to green first.
9. Adjust the TRIP LEVEL setting back to the desired position.

## 14 SPECIFICATIONS

### 14.1 PGR-8800

#### Supply:

Universal:	20 VA, 100 to 240 Vac (+10%, -15%) 50/60 Hz, 8 W, 110 to 250 Vdc (+10%, -20%)
Low Voltage:	4 W, 14 to 48 Vdc (+10%, -20%)
Backup Battery (user supplied):	24 Vdc lead-acid, 2 to 15 Ah capacity Charged at 27.5 Vdc, 200 mA max when universal supply is used

#### Optical Settings:

External Sensors:	Up to 24 (6 per unit)
Sensor Types:	PGA-LS10, PGA-LS20, PGA-LS30 all with sensor check
Trip Sensitivity Adjustment:	1 to 9 corresponding to Standard: 9 to 25 klux Sensitive: 3 to 25 klux

Trip Time Settings:	0 to 20,000 ms (0.8 ms effective minimum)
---------------------	---

#### Trip Coil Output:

Type:	IGBT Switch
Configuration:	Normally Open (Form A)
UL Rating:	120/240 Vac, 1800 VA, 0.75 A maximum continuous, 125/250 Vdc, 138 VA, 0.75 A maximum continuous

#### Supplemental Rating:

Make/Carry 0.2 s:	30 A
Voltage Rating <sup>1</sup> :	24 to 300 Vac, 24 to 300 Vdc
Current Rating:	20 A for 2 s, 10 A for 5 s

Control Voltage Alarm:	5 V
Operating Modes:	Shunt or Undervoltage
Protection:	320 Vac MOV, thermally protected
Isolation:	1,000 Vac
Pulse Duration:	1 to 5 s, configurable
On-State Voltage Drop:	2.5 V at 5 A, 25°C (77°F) 4.0 V at 10 A, 25°C (77°F)

#### Output Relays:

Main Relays:	Online, Service, Tripped
Contact Configuration:	Change-over (Form C)
UL Contact Rating:	5 A Resistive, 250 Vac 5 A Resistive, 30 Vdc

---

Supplemental Contact Rating:	
Make/Carry 0.2 s:	30 A
Rating Code:	B300, R300
Break:	
dc:	28 W Resistive
ac:	1500 VA (PF=1.0) 360 VA (PF=0.4)
	Subject to maximums of 5 A and 250 V (ac or dc)
Status Relays:	Online, terminal 49 (STO) Service, terminal 53 (STS) Tripped, terminal 57 (STT)
Contact Configuration:	Normally Open (Form A), reference to terminal 45 (COM)
UL Rating:	100 mA, 50 Vac/Vdc
Supplemental Rating:	
Contact Rating:	3 A Resistive, 240 Vac 3 A Resistive, 30 Vdc
Terminals (including sensors):	Wire Clamping, 22-12 AWG (0.14 to 2.5 mm <sup>2</sup> ) copper conductors
Torque:	4 to 5.5 lbf-in (0.45 to 0.62 N·m)
Current Inputs:	
Full Scale:	5 A Secondary
Continuous:	10 A Secondary
Thermal Withstand:	75 A for 1 s
Burden:	< 0.25 VA at 5 A
Current Sensor Class:	Protection Class 10P5 or better
Trip Time:	1 to 20,000 ms
Trip Level:	
Overcurrent 1:	150 to 1,000% of rated nominal load current
Overcurrent 2:	150 to 1,000% of rated nominal load current
Accuracy:	1 A secondary
Resolution:	100 mA secondary
Isolation:	500 Vac
Local Interface:	USB 1.1
Communications Interface:	
Protocol:	Modbus <sup>®</sup> RTU
Configuration:	TIA-485 Isolated, 2-wire multi-drop
Bus Length:	10 m (32.8 ft)
Cable:	Shielded twisted pair, Belden 3105A or equivalent

System Expansion:	Link up to four units
Internal Real-Time Clock:	
Battery <sup>2</sup> :	CR1632
Life:	Minimum 10 years
Dimensions:	
Height:	130 mm (5.1 in)
Width:	200 mm (7.9 in)
Depth:	54 mm (2.1 in)
Shipping Weight:	0.9 kg (2 lb)
Mounting:	35 mm DIN rail or surface mount
Environment:	
Operating Temperature <sup>3</sup> :	-40 to 70°C (-40°F to 158°F)
Storage Temperature <sup>3</sup> :	-40 to 70°C (-40°F to 158°F)
Humidity:	93% Non-condensing
Altitude:	
Below 2,000 m (6,500 ft):	Normal Operation
Above 2,000 m (6,500 ft):	24 Vdc supply only, shunt trip only
Above 4,000 m (13,000 ft):	Contact Littelfuse for further information.
EMC Tests:	
Verification tested in accordance with	EN60255-26:2009.
1 MHz Burst:	IEC 60255-22-1 ± 1 kV differential mode (line-to-line) ± 2.5 kV common mode
Electrostatic Discharge:	IEC 60255-22-2 ± 6 kV Contact Discharge (direct and indirect) ± 8 kV Air Discharge
Radiated RF Immunity:	IEC 60255-22-3 10 V/m, 80-1,000 MHz, 80% AM (1 kHz) 10 V/m, 1.4 to 2.7 GHz, 80% AM (1 kHz)

Fast Transient:	IEC 60255-22-4 Class A: $\pm 4$ kV (on AC mains)
Surge Immunity:	IEC 60255-22-5 $\pm 4$ kV differential mode (on AC lines) $\pm 2$ kV common mode (on AC lines) $\pm 2$ kV common mode (on I/O ports) $\pm 1$ kV differential mode (on I/O ports)
Conducted RF Immunity:	IEC 60255-22-6 10 Vrms, 0.15-80 MHz 80% AM (1 kHz)
Power Frequency:	IEC 60255-22-7 Not applicable Cables are < 10 m
Magnetic Field Immunity:	IEC 61000-4-8 50 Hz and 60 Hz 30 A/m and 300 A/m
Current Harmonics and Voltage Fluctuations:	IEC 61000-3-2 and IEC 61000-3-3 Class A
Radiated and Conducted Emissions:	CISPR 22:2008-09 / EN55022:2010 Class A
Voltage Interruptions:	IEC 60255-11 and IEC 60255-29 100% Interrupts 3 x for 5 ms, 10 ms, 20 ms, 50 ms, 100 ms, 200 ms
Vibration:	IEC 60255-21-1 (Vibration, shock, and seismic)
Safety:	IEC 61010-1: 2010 3 <sup>rd</sup> Edition Safety Requirements for Electrical Equipment for Measurement, Control, and Laboratory Use – Part I



Certification:

CSA



UL Listed



UL508 Industrial Control Equipment<sup>4</sup>

Australia



CE, European Union



EMC standards: EN60255-26

FCC



Surge Withstand:

ANSI/IEEE C37.90.1-2002 (Oscillatory and Fast Transient)

DNV Type Approval

**14.2 Sensors**

	<b>PGA-LS10</b>	<b>PGA-LS20 and PGA-LS30</b>
Type:	Point sensor	Fiber-optic sensor
Detection Zone:	180 x 360° (half sphere)	360° along fiber
Output:	0-35 mA	0-35 mA
Electrical Cable:	Shielded 3-wire 20 AWG (0.5 mm <sup>2</sup> ) electrical cable	Shielded 3-wire 20 AWG (0.5 mm <sup>2</sup> ) electrical cable
Factory Cable Length:	10 m (33 ft) electrical cable	<b>PGA-LS20:</b> 8 m (26 ft) active; 10 m (33 ft) total (2 m (7 ft) shielded), 2 x 10 m electrical cable <b>PGA-LS30:</b> 18 m (59 ft) active; 20 m (66 ft) total (2 m (7 ft) shielded), 2 x 10 m (33 ft) electrical cable
Max. Elec. Cable Length:	50 m (164 ft)	50 m (164 ft)
Sensor Check:	Built-in LED for visual feedback	Built-in LED for visual feedback
Dimensions:	32 x 52 x 24 mm (1.3 x 2.0 x 0.9 in)	Transmitter and Receiver: 32 x 56 x 19 mm (1.3 x 2.2 x 0.7 in)
Enclosure:	IP 30	IP 30

PGR-8800 uses the open source components FreeRTOS and FreeMODBUS internally. For license, version, and source-code information please contact [opensource@littelfuse.com](mailto:opensource@littelfuse.com).

## 15 ORDERING INFORMATION

PGR-8800-00-<sup>(5)</sup>

Options:

Blank - No Conformal Coating

CC - Conformal Coating

Accessories:

PGA-LS10	Point Sensor
PGA-LS20	Fiber-Optic Sensor, 8 m (26 ft) active length
PGA-LS30	Fiber-Optic Sensor, 18 m (59 ft) active length
PGA-0031	DIN-rail mounting brackets
PGA-1100	Diode Logic Unit
PGA-FLSH-01	Photo Flash, CE and RoHS

## 16 WARRANTY

The PGR-8800 Arc-Flash Relay is warranted to be free from defects in material and workmanship for a period of five years from the date of purchase.

Littelfuse will (at Littelfuse option) repair, replace, or refund the original purchase price of a PGR-8800 that is determined by Littelfuse to be defective if it is returned to the factory, freight prepaid, within the warranty period. This warranty does not apply to repairs required as a result of misuse, negligence, an accident, improper installation, tampering, or insufficient care. Littelfuse does not warrant products repaired or modified by non-Littelfuse personnel.

### NOTES:

- <sup>1</sup> Contact Littelfuse for trip coil voltages higher than 300 Vac/Vdc.
- <sup>2</sup> Battery is mounted in an internal socket and should be changed by qualified service personnel only. Contact your distributor for more information.
- <sup>3</sup> Temperature range applicable to hardware revision 2.3 and higher. Refer to Appendix E for details.
- <sup>4</sup> The PGR-8800 Arc Flash Relay is currently listed as a protective relay (UL category NRGU) and complies with the UL508 Industrial Control Equipment standard. UL did not evaluate the functionality of the arc fault protection afforded by this product. A file review will occur when the requirements for investigation of arc detection and mitigation systems are developed and additional tests will be performed if required.
- <sup>5</sup> Hardware revision 2.1 and higher includes UL, CE, and RCM certification. Hardware revision 2.0 includes UL and C-Tick certification. Refer to Appendix E for details.

## APPENDIX A PGR-8800 MODBUS RTU PROTOCOL

### A.1 PROTOCOL

The MODBUS RTU protocol is implemented in the PGR-8800, and allows up to four modules to be connected using a 2-wire TIA-485 bus. The MODBUS interface will provide status information for sensors, analog inputs, digital inputs, digital outputs, and numerous event and error flags. It also provides the ability to remotely reset the PGR-8800. Writes are not allowed by default.

#### A.1.1 Configuration Setup



### PGR-8800 Configuration Software

General	Optical Sensors	Current Sensors	Inputs	Online Output	Service Output	Tripped Output	Trip Coil Output	Comms	Advanced	About	
<b>Comms</b>											
<b>Link Interface</b>											
Is used for								MODBUS			<a href="#">Undo</a> <a href="#">Reset</a>
NOTE: Changes to this parameter will reboot the unit to complete the change.											
<b>MODBUS Configuration</b>											
Unit address								1			<a href="#">Undo</a> <a href="#">Reset</a>
Baud rate								19200			<a href="#">Undo</a> <a href="#">Reset</a>
Parity								Even			<a href="#">Undo</a> <a href="#">Reset</a>
Stopbits								Auto			<a href="#">Undo</a> <a href="#">Reset</a>
Allow writes via MODBUS								<input type="checkbox"/>			<a href="#">Undo</a> <a href="#">Reset</a>
Save All		Reset (This Tab)		Undo (This Tab)		Save and Exit		Exit			

### A.2 MESSAGE SYNCHRONIZATION

Message synchronization is accomplished by detection of an idle communication line. The communication line is considered idle when no communication exists for an equivalent delay of 3.5 characters.

The first byte received after idle-line detection is interpreted as the address byte of the next message. Message bytes must be transmitted in a continuous stream until the complete message has been sent. If a delay of more than 3.5 characters exists within the message, the message is discarded. Response messages from the PGR-8800 are delayed by at least 3.5 character delays.

### A.3 ERROR CHECKING

Modbus RTU uses a 16-bit cyclic redundancy check (CRC). The error check includes all of the message bytes, starting with the first address byte. When a CRC error is detected, the message is discarded and there will be no response.

## **A.4 FUNCTION CODES SUPPORTED**

The PGR-8800 Modbus Protocol supports the following function codes:

- Read Holding registers (Function code 3)
- Read Input registers (Function code 4)
- Write Single register\* (Function code 6)
- Read Slave ID (Function code 11)
- Write Multiple registers\* (Function code 16)

\*If writing is enabled in the configuration

### **A.4.1 Read Input/Holding Registers (Code 04/03)**

The first byte of the read message is the slave address. The second byte is the function code. Bytes three and four indicate the starting register. The next two bytes specify the number of 16-bit registers to read. The last two bytes contain the CRC code for the message.

TABLE A.1 READ REGISTERS (CODE 04/03)

HEX BYTE	DESCRIPTION
Byte 1	Slave Address
Byte 2	Function Code
Byte 3	MSB Register Address
Byte 4	LSB Register Address
Byte 5	MSB Number of Registers
Byte 6	LSB Number of Registers
Byte 7	LSB CRC
Byte 8	MSB CRC

The two-byte values of starting register and number of registers to read are transmitted with the high-order byte followed by the low-order byte. The CRC value is sent with the LSB followed by the MSB.

### **A.4.2 Write to Register**

Function Code 6 or 16 is used to make set-point changes.

#### **A.4.2.1 Write Single Register (Code 6)**

The function code format for writing a single register is shown in Table A.2.

The message consists of the slave address followed by the Function Code 6 and two 16-bit values. The first 16-bit value specifies the register to be modified and the second value is the 16-bit data.

TABLE A.2 WRITE SINGLE REGISTER (CODE 6)

HEX BYTE	DESCRIPTION
Byte 1	Slave Address
Byte 2	Function Code
Byte 3	MSB Register Address
Byte 4	LSB Register Address
Byte 5	MSB of Data
Byte 6	LSB of Data
Byte 7	LSB of CRC
Byte 8	MSB of CRC

### **A.4.2.2 Write Multiple Registers (Code 16)**

The function-code format in Table A.3 can be used for writing single or multiple registers.

TABLE A.3 WRITE MULTIPLE REGISTERS (CODE 16)

HEX BYTE #	DESCRIPTION
Byte 1	Slave Address
Byte 2	Function Code
Byte 3	MSB Register Address
Byte 4	LSB Register Address
Byte 5	MSB of Quantity
Byte 6	LSB of Quantity
Byte 7	Byte Count
.	MSB of Data
.	LSB of Data
.	LSB of CRC
Byte n	MSB of CRC

The slave will reply with the slave address, function code, register address, and the quantity followed by the CRC code for a total of eight bytes.

### **A.4.3 Exception Responses**

The PGR-8800 will return appropriate error codes as per the standard for malformed or out-of-range requests.

## **A.5 PGR-8800 DATABASE**

Appendix B contains the Modbus Registers in the Communications Database Table. The table starts at register 200 and each register is 16-bits wide.

## **A.6 SPECIFICATIONS**

Interface	Isolated TIA-485, 2-wire multi-drop
Protocol	Modbus® RTU
Baud Rate	1,200 to 19,200 bit/s
Bit Format	8 bits, even or odd parity, one or two stop bits
Maximum Cable Length	10 m (33 ft)
Cable Type	Shielded Twisted Pair, Belden 3105A or equivalent
Terminals	22 to 12 AWG, (0.1 to 2.5 mm <sup>2</sup> ) conductors

**NOTE:** The TIA-485 hardware is shared with the Link function and can either be configured for Link or Modbus but not both at the same time.

### **References**

[1] “MODBUS over serial line specification and implementation guide V1.02” - [http://www.modbus.org/docs/Modbus\\_over\\_serial\\_line\\_V1\\_02.pdf](http://www.modbus.org/docs/Modbus_over_serial_line_V1_02.pdf)

[2] “MODBUS Application protocol Specification V1.1b” - [http://www.modbus.org/docs/Modbus\\_Application\\_Protocol\\_V1\\_1b.pdf](http://www.modbus.org/docs/Modbus_Application_Protocol_V1_1b.pdf)

**APPENDIX B MODBUS COMMUNICATIONS DATABASE TABLE**

PGR-8800 REGISTER (DECIMAL)	MODBUS REGISTER (DECIMAL)	DESCRIPTION	ACCESS	TERMINAL	TYPE
<b>Analog Inputs (Values)</b>					
199	40200	Number of analog inputs on system	Read Only	N/A	16-bit word, always 22
200	40201	Light on Sensor 1	Read Only	3	T1
201	40202	Light on Sensor 2	Read Only	7	T1
202	40203	Light on Sensor 3	Read Only	11	T1
203	40204	Light on Sensor 4	Read Only	15	T1
204	40205	Light on Sensor 5	Read Only	19	T1
205	40206	Light on Sensor 6	Read Only	23	T1
206	40207	Current on CT1	Read Only	25 – 26	T2
207	40208	Current on CT2	Read Only	27 – 28	T2
208	40209	Current on CT3	Read Only	29 – 30	T2
213	40214	Light on Front Sensor	Read Only	N/A	T1
<b>Analog Inputs (Max value since last read)</b>					
299	40300	Number of analog inputs on system	Read Only	N/A	16-bit word, always 22
300	40301	Light on Sensor 1	Read Only	3	T1
301	40302	Light on Sensor 2	Read Only	7	T1
302	40303	Light on Sensor 3	Read Only	11	T1
303	40304	Light on Sensor 4	Read Only	15	T1
304	40305	Light on Sensor 5	Read Only	19	T1
305	40306	Light on Sensor 6	Read Only	23	T1
306	40307	Current on CT1	Read Only	25 – 26	T2
307	40308	Current on CT2	Read Only	27 – 28	T2
308	40309	Current on CT3	Read Only	29 – 30	T2
313	40314	Light on Front Sensor	Read Only	N/A	T1
<b>Analog Inputs (Min value since last read)</b>					
399	40400	Number of analog inputs on system	Read Only	N/A	16-bit word, always 22
400	40401	Light on Sensor 1	Read Only	3	T1
401	40402	Light on Sensor 2	Read Only	7	T1
402	40403	Light on Sensor 3	Read Only	11	T1
403	40404	Light on Sensor 4	Read Only	15	T1
404	40405	Light on Sensor 5	Read Only	19	T1
405	40406	Light on Sensor 6	Read Only	23	T1
406	40407	Current on CT1	Read Only	25 – 26	T2
407	40408	Current on CT2	Read Only	27 – 28	T2
408	40409	Current on CT3	Read Only	29 – 30	T2
413	40414	Light on Front Sensor	Read Only	N/A	T1
<b>Sensor Input Status</b>					
499	40500	Number of light sensors on system	Read Only	N/A	16-bit word, always 6
500	40501	Status of Sensor 1	Read Only	3	T3
501	40502	Status of Sensor 2	Read Only	7	T3
502	40503	Status of Sensor 3	Read Only	11	T3
503	40504	Status of Sensor 4	Read Only	15	T3
504	40505	Status of Sensor 5	Read Only	19	T3
505	40506	Status of Sensor 6	Read Only	23	T3

<b>PGR-8800 REGISTER (DECIMAL)</b>	<b>MODBUS REGISTER (DECIMAL)</b>	<b>DESCRIPTION</b>	<b>ACCESS</b>	<b>TERMINAL</b>	<b>TYPE</b>
<b>Power Voltages</b>					
599	40600	Number of power inputs on system	Read Only	N/A	16-bit word, always 5
600	40601	Output from AC supply	Read Only	35	T4
601	40602	Input from DC terminal	Read Only	34	T5
602	40603	Input from battery	Read Only	35	T6
603	40604	Output from 5 V supply	Read Only	N/A	T7
604	40605	Output from sensor supply	Read Only	N/A	T8
<b>Mode Control</b>					
1099	41100	Number of user-writable mode selections	Read Only	N/A	16-bit word, always 3
1100	41101	Mode	Read/Write	N/A	T9
1101	41102	Power	Read Only	N/A	T10
1102	41103	Error	Read Only	N/A	T11
<b>Digital Inputs</b>					
1199	41200	Number of Digital Inputs on system	Read Only	N/A	16-bit word, always 3
1200	41201	Status of Inhibit Input	Read Only	39 – 40	T12
1201	41202	Status of Trip Input	Read Only	41 – 42	T12
1202	41203	Status of Reset Input	Read/Write	43 – 44	T13
<b>Address</b>					
1299	41300	Number of relay outputs on system	Read Only	N/A	16-bit word, always 4
1300	41301	Status of Online output	Read Only	46 – 49	T14
1301	41302	Status of Service output	Read Only	50 – 53	T14
1302	41303	Status of Tripped output	Read Only	54 – 57	T14
1303	41304	Status of IGBT output	Read Only	59 – 60	T14
<b>Event Flags</b>					
1499	41500	Number of status flags available	Read Only	N/A	16-bit word, always 60
1500	41501	Not used	Read Only	N/A	T15
1501	41502	Sensor 1	Read Only	N/A	T15
1502	41503	Sensor 2	Read Only	N/A	T15
1503	41504	Sensor 3	Read Only	N/A	T15
1504	41505	Sensor 4	Read Only	N/A	T15
1505	41506	Sensor 5	Read Only	N/A	T15
1506	41507	Sensor 6	Read Only	N/A	T15
1507	41508	Sensor front	Read Only	N/A	T15
1508	41509	Analog OR of all sensors	Read Only	N/A	T15
1509	41510	Current inhibit	Read Only	N/A	T15
1510	41511	Current overload 1	Read Only	N/A	T15
1511	41512	Current overload 2	Read Only	N/A	T15
1512	41513	Not used	Read Only	N/A	T15
1513	41514	Inhibit input	Read Only	N/A	T15
1514	41515	Trip input	Read Only	N/A	T15
1515	41516	Reset input	Read Only	N/A	T15
1516	41517	Mode button	Read Only	N/A	T15
1517	41518	Trip button long press	Read Only	N/A	T15
1519	41519	Reset button	Read Only	N/A	T15
1519	41520	Reset button long press	Read Only	N/A	T15
1520	41521	Link trip	Read Only	N/A	T15
1521	41522	Link command inhibit	Read Only	N/A	T15

<b>PGR-8800 REGISTER (DECIMAL)</b>	<b>MODBUS REGISTER (DECIMAL)</b>	<b>DESCRIPTION</b>	<b>ACCESS</b>	<b>TERMINAL</b>	<b>TYPE</b>
1522	41523	Link command trip	Read Only	N/A	T15
1523	41524	Link command reset	Read Only	N/A	T15
1524	41525	Modbus command inhibit	Read Only	N/A	T15
1525	41526	Modbus command trip	Read Only	N/A	T15
1526	41527	Modbus command reset	Read Only	N/A	T15
1527	41528	Test or USB active	Read Only	N/A	T15
1528	41529	State timeout	Read Only	N/A	T15
1529	41530	Error timeout	Read Only	N/A	T15
1530	41531	State done	Read Only	N/A	T15
1531	41532	Trip log complete	Read Only	N/A	T15
1532	41533	Link command service	Read Only	N/A	T15
1533	41534	Link command online	Read Only	N/A	T15
1534	41535	Modbus command service	Read Only	N/A	T15
1535	41536	Modbus command online	Read Only	N/A	T15
1536	41537	Error link	Read Only	N/A	T15
1537	41538	Error task failed	Read Only	N/A	T15
1538	41539	Error power failure	Read Only	N/A	T15
1539	41540	Error IGBT missing voltage	Read Only	N/A	T15
1540	41541	Error sensor power failure	Read Only	N/A	T15
1541	41542	Link command error	Read Only	N/A	T15
1542	41543	Link command setup	Read Only	N/A	T15
1543	41544	Trip button	Read Only	N/A	T15
1544	41545	Output trip momentary command	Read Only	N/A	T15
1545	41546	CB closed feedback	Read Only	N/A	T15
1546	41547	CB clearing failure	Read Only	N/A	T15
1547	41548	Current detect for CB failure	Read Only	N/A	T15
1548	41549	Currently AC powered	Read Only	N/A	T15
1549	41550	Currently DC powered	Read Only	N/A	T15
1550	41551	Local CB tripped in this event	Read Only	N/A	T15
1551	41552	Upstream CB tripped via Service relay	Read Only	N/A	T15
1552	41553	Upstream CB tripped via Tripped relay	Read Only	N/A	T15
1553	41554	Local CB tripped via Service relay	Read Only	N/A	T15
1554	41555	Local CB tripped via Tripped relay	Read Only	N/A	T15
1555	41556	Link alarm sent due to Light	Read Only	N/A	T15
1556	41557	Link alarm sent due to Trip	Read Only	N/A	T15
1557	41558	Link alarm sent due to Trip fault - tripped Upstream	Read Only	N/A	T15
1558	41559	USB Connected	Read Only	N/A	T15
1559	41560	Local CB tripped via Online relay	Read Only	N/A	T15
<b>Status Flags</b>					
1599	41600	Number of status flags available	Read Only	N/A	16-bit word, always 60
1600	41601	Not used	Read Only	N/A	T15
1601	41602	Sensor 1	Read Only	N/A	T15
1602	41603	Sensor 2	Read Only	N/A	T15
1603	41604	Sensor 3	Read Only	N/A	T15
1604	41605	Sensor 4	Read Only	N/A	T15
1605	41606	Sensor 5	Read Only	N/A	T15
1606	41607	Sensor 6	Read Only	N/A	T15
1607	41608	Sensor front	Read Only	N/A	T15



<b>PGR-8800 REGISTER (DECIMAL)</b>	<b>MODBUS REGISTER (DECIMAL)</b>	<b>DESCRIPTION</b>	<b>ACCESS</b>	<b>TERMINAL</b>	<b>TYPE</b>
1608	41609	Analog OR of all sensors	Read Only	N/A	T15
1609	41610	Current inhibit	Read Only	N/A	T15
1610	41611	Current overload 1	Read Only	N/A	T15
1611	41612	Current overload 2	Read Only	N/A	T15
1612	41613	Not used	Read Only	N/A	T15
1613	41614	Inhibit input	Read Only	N/A	T15
1614	41615	Trip input	Read Only	N/A	T15
1615	41616	Reset input	Read Only	N/A	T15
1616	41617	Mode button	Read Only	N/A	T15
1617	41618	Trip button long press	Read Only	N/A	T15
1618	41619	Reset button	Read Only	N/A	T15
1619	41620	Reset button long press	Read Only	N/A	T15
1620	41621	Link trip	Read Only	N/A	T15
1621	41622	Link command inhibit	Read Only	N/A	T15
1622	41623	Link command trip	Read Only	N/A	T15
1623	41624	Link command reset	Read Only	N/A	T15
1624	41625	Modbus command inhibit	Read Only	N/A	T15
1625	41626	Modbus command trip	Read Only	N/A	T15
1626	41627	Modbus command reset	Read Only	N/A	T15
1627	41628	Test or USB active	Read Only	N/A	T15
1628	41629	State timeout	Read Only	N/A	T15
1629	41630	Error timeout	Read Only	N/A	T15
1630	41631	State done	Read Only	N/A	T15
1631	41632	Trip log complete	Read Only	N/A	T15
1632	41633	Link command service	Read Only	N/A	T15
1633	41634	Link command online	Read Only	N/A	T15
1634	41635	Modbus command service	Read Only	N/A	T15
1635	41636	Modbus command online	Read Only	N/A	T15
1636	41637	Error link	Read Only	N/A	T15
1637	41638	Error task failed	Read Only	N/A	T15
1638	41639	Error power failure	Read Only	N/A	T15
1639	41640	Error IGBT missing voltage	Read Only	N/A	T15
1640	41641	Error sensor power failure	Read Only	N/A	T15
1641	41642	Link command error	Read Only	N/A	T15
1642	41643	Link command setup	Read Only	N/A	T15
1643	41644	Trip button	Read Only	N/A	T15
1644	41645	Output trip momentary command	Read Only	N/A	T15
1645	41646	CB closed feedback	Read Only	N/A	T15
1646	41647	CB clearing failure	Read Only	N/A	T15
1647	41648	Current detect for CB failure	Read Only	N/A	T15
1648	41649	Currently AC powered	Read Only	N/A	T15
1649	41650	Currently DC powered	Read Only	N/A	T15
1650	41651	Local CB tripped in this event	Read Only	N/A	T15
1651	41652	Upstream CB tripped via Service relay	Read Only	N/A	T15
1652	41653	Upstream CB tripped via Tripped relay	Read Only	N/A	T15
1653	41654	Local CB tripped via Service relay	Read Only	N/A	T15
1654	41655	Local CB tripped via Tripped relay	Read Only	N/A	T15
1655	41656	Link alarm sent due to Light	Read Only	N/A	T15

<b>PGR-8800 REGISTER (DECIMAL)</b>	<b>MODBUS REGISTER (DECIMAL)</b>	<b>DESCRIPTION</b>	<b>ACCESS</b>	<b>TERMINAL</b>	<b>TYPE</b>
1656	41657	Link alarm sent due to Trip	Read Only	N/A	T15
1657	41658	Link alarm sent due to Trip fault - tripped Upstream	Read Only	N/A	T15
1658	41659	USB Connected	Read Only	N/A	T15
1659	41660	Local CB tripped via Online relay	Read Only	N/A	T15
<b>Error Flags</b>					
1699	41700	Number of status flags available	Read Only	N/A	16-bit word, always 60
1700	41701	Not used	Read Only	N/A	T15
1701	41702	Sensor 1	Read Only	N/A	T15
1702	41703	Sensor 2	Read Only	N/A	T15
1703	41704	Sensor 3	Read Only	N/A	T15
1704	41705	Sensor 4	Read Only	N/A	T15
1705	41706	Sensor 5	Read Only	N/A	T15
1706	41707	Sensor 6	Read Only	N/A	T15
1707	41708	Sensor front	Read Only	N/A	T15
1708	41709	Analog OR of all sensors	Read Only	N/A	T15
1709	41710	Current inhibit	Read Only	N/A	T15
1710	41711	Current overload 1	Read Only	N/A	T15
1711	41712	Current overload 2	Read Only	N/A	T15
1712	41713	Not used	Read Only	N/A	T15
1713	41714	Inhibit input	Read Only	N/A	T15
1714	41715	Trip input	Read Only	N/A	T15
1715	41716	Reset input	Read Only	N/A	T15
1716	41717	Mode button	Read Only	N/A	T15
1717	41718	Trip button long press	Read Only	N/A	T15
1718	41719	Reset button	Read Only	N/A	T15
1719	41720	Reset button long press	Read Only	N/A	T15
1720	41721	Link trip	Read Only	N/A	T15
1721	41722	Link command inhibit	Read Only	N/A	T15
1722	41723	Link command trip	Read Only	N/A	T15
1723	41724	Link command reset	Read Only	N/A	T15
1724	41725	Modbus command inhibit	Read Only	N/A	T15
1725	41726	Modbus command trip	Read Only	N/A	T15
1726	41727	Modbus command reset	Read Only	N/A	T15
1727	41728	Test or USB active	Read Only	N/A	T15
1728	41729	State timeout	Read Only	N/A	T15
1729	41730	Error timeout	Read Only	N/A	T15
1730	41731	State done	Read Only	N/A	T15
1731	41732	Trip log complete	Read Only	N/A	T15
1732	41733	Link command service	Read Only	N/A	T15
1733	41734	Link command online	Read Only	N/A	T15
1734	41735	Modbus command service	Read Only	N/A	T15
1735	41736	Modbus command online	Read Only	N/A	T15
1736	41737	Error link	Read Only	N/A	T15
1737	41738	Error task failed	Read Only	N/A	T15
1738	41739	Error power failure	Read Only	N/A	T15
1739	41740	Error IGBT missing voltage	Read Only	N/A	T15
1740	41741	Error sensor power failure	Read Only	N/A	T15
1741	41742	Link command error	Read Only	N/A	T15
1742	41743	Link command setup	Read Only	N/A	T15

PGR-8800 REGISTER (DECIMAL)	MODBUS REGISTER (DECIMAL)	DESCRIPTION	ACCESS	TERMINAL	TYPE
1743	41744	Trip button	Read Only	N/A	T15
1744	41745	Output trip momentary command	Read Only	N/A	T15
1745	41746	CB closed feedback	Read Only	N/A	T15
1746	41747	CB clearing failure	Read Only	N/A	T15
1747	41748	Current detect for CB failure	Read Only	N/A	T15
1748	41749	Currently AC powered	Read Only	N/A	T15
1749	41750	Currently DC powered	Read Only	N/A	T15
1750	41751	Local CB tripped in this event	Read Only	N/A	T15
1751	41752	Upstream CB tripped via Service relay	Read Only	N/A	T15
1752	41753	Upstream CB tripped via Tripped relay	Read Only	N/A	T15
1753	41754	Local CB tripped via Service relay	Read Only	N/A	T15
1754	41755	Local CB tripped via Tripped relay	Read Only	N/A	T15
1755	41756	Link alarm sent due to Light	Read Only	N/A	T15
1756	41757	Link alarm sent due to Trip	Read Only	N/A	T15
1757	41758	Link alarm sent due to Trip fault - tripped Upstream	Read Only	N/A	T15
1758	41759	USB Connected	Read Only	N/A	T15
1759	41760	Local CB tripped via Online relay	Read Only	N/A	T15

**TYPES:**

- T1: 16-bit word, 0-1023, approx 35 lux/unit; Offset at 0 Klux is dependent on software revision and sensor type.
- T2: 16-bit word, 0-1023, approx 100 mA/unit; Offset at 0 A is approximately 512.
- T3: Reading: 0=Not detected; 1=Detected; 2=Not possible, old sensor.
- T4: In mV, nominally 26 V.
- T5: In mV, range 8-48 V. May wrap on systems not capable of reading unsigned 16 bit values.
- T6: In mV, range 20-28V.
- T7: In mV, nominally 5V.
- T8: In mV, nominally 4.5V.
- T9: Reading: 0=Online mode; 1=Service mode; Writing: 0=Set online mode; 1=Set service mode, writing only allowed if explicitly enabled in configuration.
- T10: Reading: 0=AC present; 1=DC present; 2=On battery power; 3=Battery low.
- T11: Reading: 0=No errors; 1=Error.
- T12: Reading: 0=Inactive; 1=Active; 2=Cable Broken.
- T13: Reading: 0=Inactive; 1=Active; 2=Cable Broken; Writing: 1=Reset trip (self-resets), writing only allowed if explicitly enabled in configuration.
- T14: Reading: 0=Open; 1=Closed.
- T15: Reading: 0=Inactive; 1=Active.

## **APPENDIX C COORDINATED TRIPPING OF UPSTREAM BREAKERS**

The PGR-8800 is designed to detect arc faults and trip the local circuit breaker, interrupting the energy supply to the arc and clearing the fault.

This appendix explains how to configure the PGR-8800 to detect if the local circuit breaker failed to operate, and to send a trip signal to the upstream breaker.

This appendix generally assumes that the reader is familiar with the standard operation and configuration of the PGR-8800.

### **C.1 SYSTEM OVERVIEW**

Circuit breaker failure detection is possible by using either an auxiliary contact from the local circuit breaker or by using the current sensor inputs on the PGR-8800 to detect phase currents after the local circuit breaker has been told to trip, or both.

The operation time of the local circuit breaker must be considered before the decision is made to trip the upstream breaker. Selecting the correct delay is described in Section C.1.3.

In the case where the PGR-8800 has detected that the local circuit breaker failed to open, the upstream breaker must be tripped. If an upstream PGR-8800 is already installed, the Link interface can be used to send a trip signal to this unit. The advantages are that only a TIA-485 connection is needed between units, and that a failure in the connection will be detected. This configuration is described in Section C.2.2.

If the unit is configured as a stand-alone device, the Service and Tripped output relays can be programmed to trip an upstream circuit breaker. See Section C.1.4.

#### **C.1.1 Circuit Breaker Feedback Detection**

An available auxiliary contact in a circuit breaker can be used to provide feedback of the main contact positions. The PGR-8800 trip inputs (T1 or T2) can be configured to detect the circuit breaker status. This function is programmed using the configuration software. See Section C.2.1 for a programming and wiring example.

#### **C.1.2 Current Sensor Detection**

The PGR-8800 current sensors can also be used to detect phase currents to verify if the local circuit breaker has operated as expected. See Section C.2.3 for a programming and wiring example.

#### **C.1.3 Total Clearing Time**

Several parameters are needed to estimate the total clearing time of a local and upstream circuit breaker. The total clearing time is defined as:

Total Clearing Time = Arc Detection Delay + Local Circuit Breaker Operating Time + Output Delay + Upstream Circuit Breaker Operating Time

##### **C.1.3.1 Arc Detection Delay**

The PGR-8800's default arc-flash detection time is one millisecond, but can be configured between 0 and 20,000 milliseconds (see section 12.2.5). This is referred to as arc detection delay. When configured to 0 ms, the effective trip time is less than 0.8 ms.

### **C.1.3.2 Circuit Breaker Operating Time**

Circuit breakers have a predetermined operating time, dependent on the type of circuit breaker. Older circuit breakers have clearing times up to eight cycles, while modern circuit breakers are able to open in one to five cycles. Refer to the specifications of the installed circuit breaker.

TABLE C.1 CIRCUIT BREAKER OPERATING TIMES

<b>CIRCUIT BREAKER OPERATING TIME</b>	<b>50 HZ</b>	<b>60 HZ</b>
8 cycles	160 ms	133 ms
5 cycles	100 ms	83 ms
3 cycles	60 ms	50 ms
2 cycles	40 ms	33 ms
1½ cycles	30 ms	25 ms
1 cycle	20 ms	17 ms

### **C.1.3.3 Output Delay**

An additional output delay can be caused by the switching time of the Service or Tripped mechanical relays (five milliseconds), or the reaction time of an upstream PGR-8800 trip coil output (when connected with the Link interface).

### **C.1.3.4 Total Clearing Time Examples**

#### **Total Clearing Time Example 1:**

Two 3-cycle breakers at 50 Hz, with the upstream breaker tripped by the Tripped relay in the local PGR-8800:

$$1 + 60 + 5 + 60 \text{ ms} = 126 \text{ ms}$$

#### **Total Clearing Time Example 2:**

Two 2-cycle breakers at 50 Hz, with the upstream circuit breaker tripped by an upstream PGR-8800 connected via Link interface:

$$1 + 40 + 1 + 40 = 82 \text{ ms}$$

### **C.1.4 Relay Output**

For smaller systems, one of the relay outputs can be configured to trip the upstream circuit breaker directly. The relay outputs are rated for pilot duty B300, and will trip most circuit breakers. See Section C.2.1 for a programming and wiring example.

### **C.1.5 Link Output**

The Link feature can be configured to trip an upstream PGR-8800. This uses the solid state high-speed trip coil output, which eliminates the delay from the mechanical relay. See Section C.2.2 for a programming and wiring example.

### C.1.6 PGA-1100 Diode Logic Unit

When several PGR-8800 protected zones are used and a common upstream circuit breaker should be tripped if any of the downstream zones experience a local clearing failure, the upstream circuit breaker may run out of inputs. The PGA-1100 Diode Logic Unit makes it possible to combine several trip outputs to the common circuit breaker. See Section C.2.6.

## C.2 APPLICATION AND CONFIGURATION

The PGR-8800 is not configured for tripping the upstream circuit breaker in the default configuration shown below:

### PGR-8800 Configuration Software

General
Optical Sensors
Current Sensors
Inputs
Online Output
Service Output
Tripped Output
Trip Coil Output
Comms
Advanced
About

#### Trip Coil Output



Trip Coil Output	
Trip Coil output function:	Indicate that the unit tripped <span style="float: right;"><a href="#">Undo</a> <a href="#">Reset</a></span>
Circuit breaker type	Shunt coil (trips when powered) <span style="float: right;"><a href="#">Undo</a> <a href="#">Reset</a></span>
Trip Coil Output Type	Pulsed <span style="float: right;"><a href="#">Undo</a> <a href="#">Reset</a></span>
<i>WARNING: 20 A for 2 s, 10 A for 5 s, 750 mA continuous rating.</i>	
Circuit breaker pulse time	<input type="text" value="1"/> seconds <span style="float: right;"><a href="#">Undo</a> <a href="#">Reset</a></span>
Report an error if trip coil is not detected	<input checked="" type="checkbox"/> <span style="float: right;"><a href="#">Undo</a> <a href="#">Reset</a></span>

Save All
Reset (This Tab)
Undo (This Tab)
Save and Exit
Exit

The configuration software hides the extra settings associated with Coordinated Tripping, as the feature is not yet enabled.

### C.2.1 Single PGR-8800 Configuration

Figure C.1 shows an incoming feeder with a circuit breaker, a bus bar, and a zone protected with a PGR-8800. All sensors are downstream of the circuit breaker, but the upstream circuit breaker can be tripped if a local circuit-breaker failure occurs.

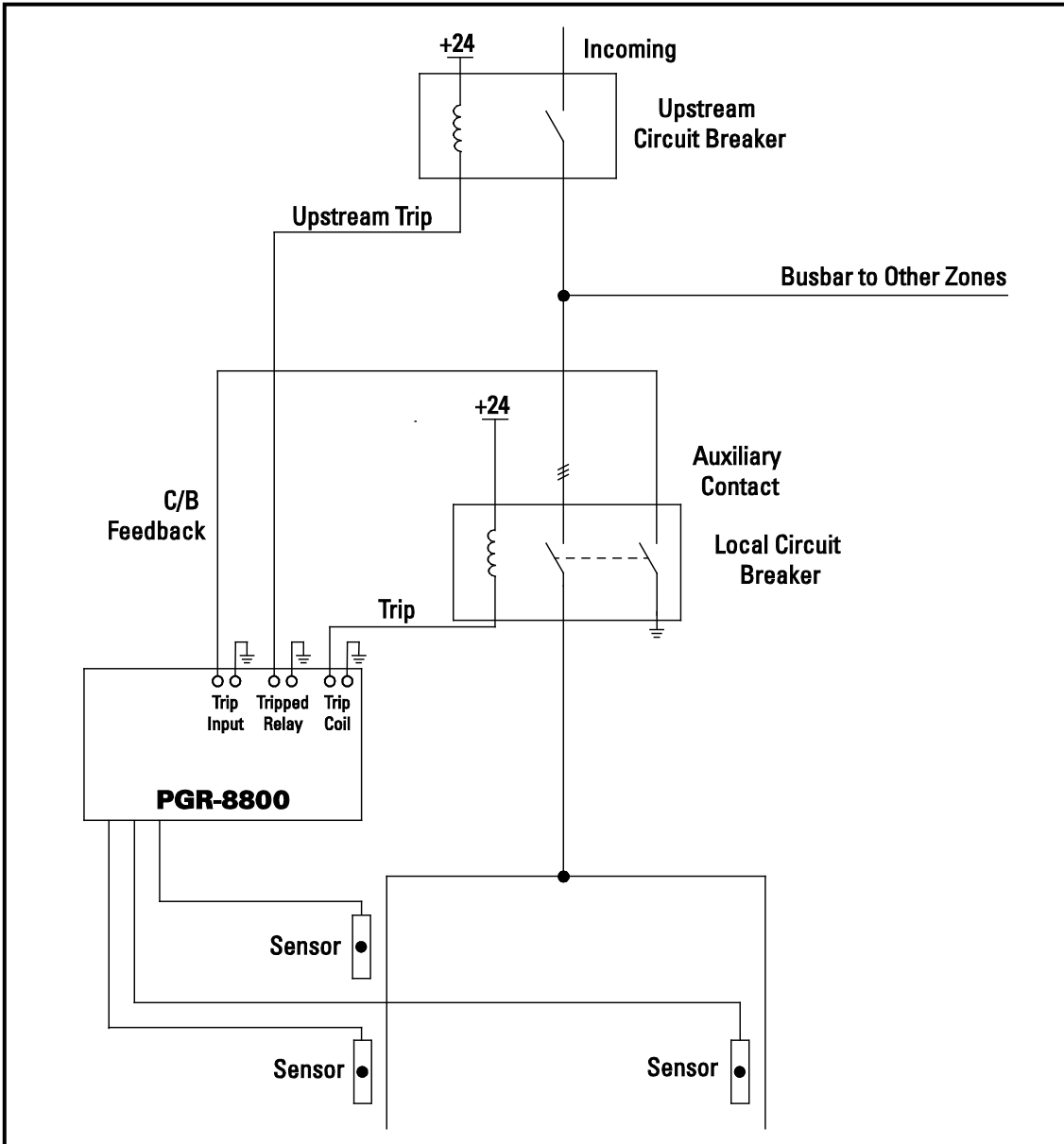

FIGURE C.1. Single PGR-8800 Configuration.

In this application, a circuit breaker with an auxiliary contact provides a trip input signal.

**Breaker Failure Options**

Detect clearing failure by trip input	<input checked="" type="checkbox"/>	<a href="#">Undo</a> <a href="#">Reset</a>
Detect clearing failure by current	<input type="checkbox"/>	<a href="#">Undo</a> <a href="#">Reset</a>
Maximum local breaker clearing time	<input type="text" value="40"/> ms	<a href="#">Undo</a> <a href="#">Reset</a>

**ERROR: Set the Trip Input to read the Circuit breaker feedback**  
**ERROR: Enable Clearing Failure on either Link (see Comms section) or on a relay output (Service or Tripped, see below) to communicate the clearing failure**

The configuration software displays two warnings to configure a digital input as a feedback signal from the circuit breaker auxiliary contact and to configure a relay output to trip an upstream circuit breaker.

In the Tripped Output section, select Trip Upstream Breaker on Clearing Failure. This will remove the associated warning message.

General Optical Sensors Current Sensors Inputs Online Output Service Output **Tripped Output** Trip Coil Output Comms Advanced About

## Tripped Output



**Tripped Output**

Tripped output function: Trip upstream breaker on clearing failure [Undo](#) [Reset](#)

*NOTE: The LED on the overlay will still indicate if the relay has tripped.*

Save All Reset (This Tab) Undo (This Tab) Save and Exit Exit

The trip coil on the upstream circuit breaker can now be connected to the Tripped output (terminals 54, 55, and 56). It is also possible to use the Service Output to trip the upstream circuit breaker.

On the Digital Inputs tab, set the Trip Input Main function to Circuit breaker feedback.

General Optical Sensors Current Sensors Inputs **Online Output** Service Output Tripped Output Trip Coil Output Comms Advanced About

## Inputs

**Inhibit Inputs**

Function: Inhibit when low (switch closed) [Undo](#) [Reset](#)

**Trip Inputs**

Main function: Circuit breaker feedback [Undo](#) [Reset](#)

*NOTE: Go to the Breaker Failure Options to setup detection of a CB failure*

Function: CB is closed when low (switch closed) [Undo](#) [Reset](#)

**Reset Inputs**

Function: Reset when low (switch closed) [Undo](#) [Reset](#)

**Breaker Failure Options**

Detect clearing failure by trip input  [Undo](#) [Reset](#)

Detect clearing failure by current  [Undo](#) [Reset](#)

Maximum local breaker clearing time 40 ms [Undo](#) [Reset](#)

Save All Reset (This Tab) Undo (This Tab) Save and Exit Exit

Select CB is closed when low (switch closed). When Trip Input T1 or T2 (terminal 41 and 42 respectively) is connected to Common (terminal 45), the monitored circuit breaker is determined to be closed.

This will remove the warning message and the configuration can be saved.



General Optical Sensors Current Sensors Inputs Online Output Service Output Tripped Output Trip Coil Output Comms Advanced About

### Trip Coil Output



#### Trip Coil Output

Trip Coil output function:	Indicate that the unit tripped	<a href="#">Undo</a> <a href="#">Reset</a>
Circuit breaker type	Shunt coil (trips when powered)	<a href="#">Undo</a> <a href="#">Reset</a>
Trip Coil Output Type	Pulsed	<a href="#">Undo</a> <a href="#">Reset</a>
<i>WARNING: 20 A for 2 s, 10 A for 5 s, 750 mA continuous rating.</i>		
Circuit breaker pulse time	2 seconds	<a href="#">Undo</a> <a href="#">Reset</a>
Report an error if trip coil is not detected	<input checked="" type="checkbox"/>	<a href="#">Undo</a> <a href="#">Reset</a>

Save All Reset (This Tab) Undo (This Tab) Save and Exit Exit

Ensure the delay time for the local circuit breaker is set correctly for the circuit breaker type. The default is a 2-cycle circuit breaker delay. See Section C.1.3.2 for instructions on how to determine the circuit breaker operating time.

### C.2.2 Dual PGR-8800 Configuration using Link Interface

The single line diagram shows an incoming feeder with a circuit breaker, a bus bar, and a zone protected with a PGR-8800. The upstream circuit breaker can be tripped by the local PGR-8800 via the Link interface if the local circuit breaker fails to operate.

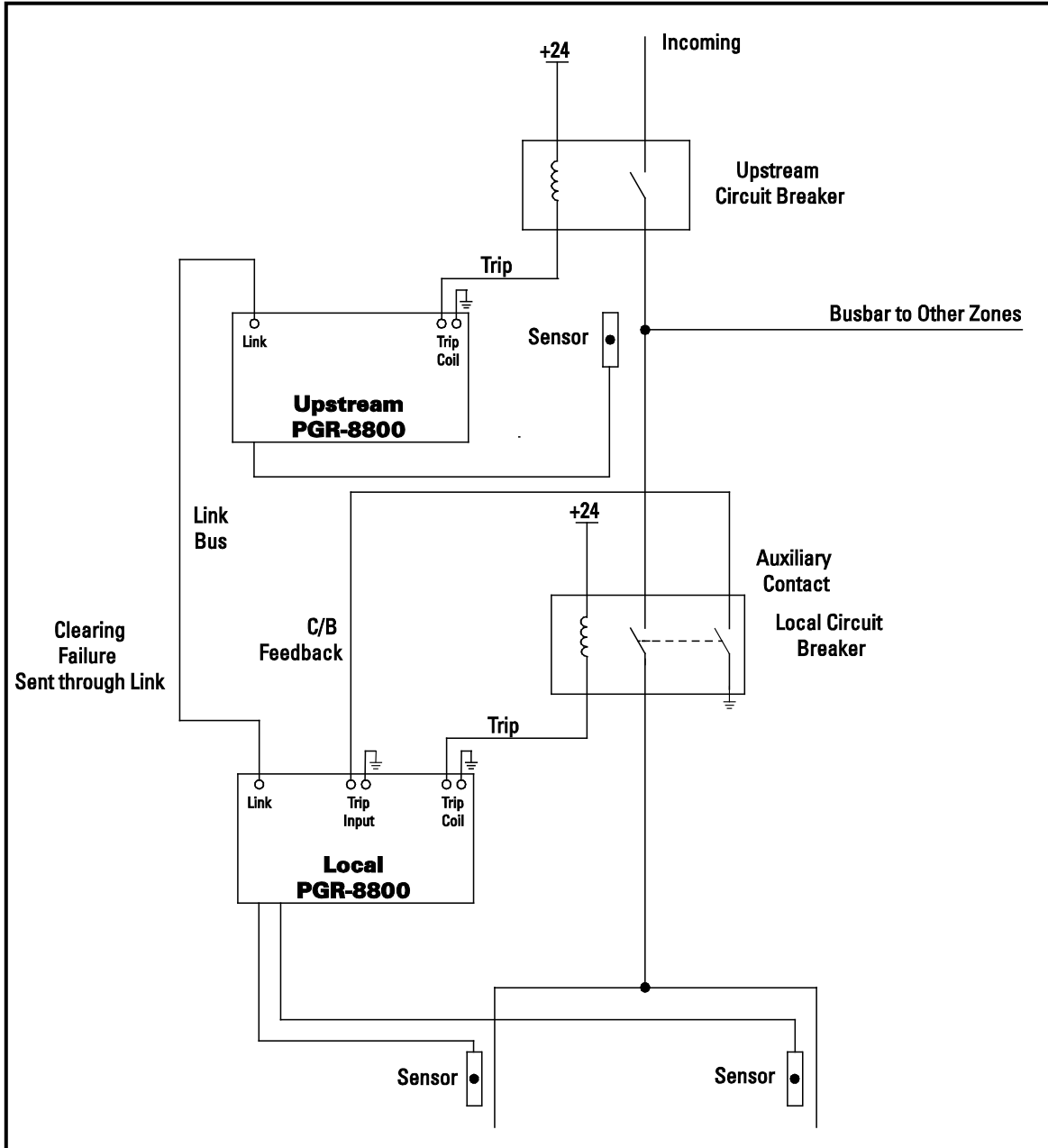

FIGURE C.2. Dual PGR-8800 Configuration using Link Interface.

The local circuit breaker auxiliary contact feedback is configured as in Section C.2.1.

Configure the local PGR-8800 to use the Link Interface. The unit address must be unique, and the number of linked units in the system must be configured.

Select Clearing Failure to allow the PGR-8800 to send the Link alarm signal to the upstream PGR-8800.

The Received Link alarm signal trips this unit is not selected. This makes it possible to have several downstream units trip a common upstream unit without tripping each other.

General Optical Sensors Current Sensors Inputs Online Output Service Output Tripped Output Trip Coil Output Comms **Advanced** About

## Comms

### Link Interface

Is used for  [Undo](#) [Reset](#)

*NOTE: Waveform capture cannot be used when the Link feature is selected.*  
*NOTE: Changes to this parameter will reboot the unit to complete the change.*

### Link Configuration

Unit address	<input type="text" value="1"/>	Must be unique, lowest must be 1	<a href="#">Undo</a> <a href="#">Reset</a>
Number of linked units in the system	<input type="text" value="2"/>	Report an error if any unit is missing.	<a href="#">Undo</a> <a href="#">Reset</a>
Send Link alarm signal on	<input type="text" value="Clearing failure"/>		<a href="#">Undo</a> <a href="#">Reset</a>
Received Link alarm signal trips this unit	<input type="checkbox"/>		<a href="#">Undo</a> <a href="#">Reset</a>
Link sends and receives the user interface	<input checked="" type="checkbox"/>		<a href="#">Undo</a> <a href="#">Reset</a>
Link sends and receives errors	<input checked="" type="checkbox"/>		<a href="#">Undo</a> <a href="#">Reset</a>

Save All Reset (This Tab) Undo (This Tab) Save and Exit Exit

The unit controlling the upstream circuit breaker is configured to receive a link alarm. The upstream PGR-8800 is configured to send a Link alarm signal, but in the current configuration, this has no effect as the local PGR-8800 is not configured to receive the Link alarm.

General Optical Sensors Current Sensors Inputs Online Output Service Output Tripped Output Trip Coil Output Comms **Advanced** About

## Comms

### Link Interface

Is used for  [Undo](#) [Reset](#)

*NOTE: Waveform capture cannot be used when the Link feature is selected.*  
*NOTE: Changes to this parameter will reboot the unit to complete the change.*

### Link Configuration

Unit address	<input type="text" value="2"/>	Must be unique, lowest must be 1	<a href="#">Undo</a> <a href="#">Reset</a>
Number of linked units in the system	<input type="text" value="2"/>	Report an error if any unit is missing.	<a href="#">Undo</a> <a href="#">Reset</a>
Send Link alarm signal on	<input type="text" value="Trip"/>		<a href="#">Undo</a> <a href="#">Reset</a>
Received Link alarm signal trips this unit	<input checked="" type="checkbox"/>		<a href="#">Undo</a> <a href="#">Reset</a>
Link sends and receives the user interface	<input checked="" type="checkbox"/>		<a href="#">Undo</a> <a href="#">Reset</a>
Link sends and receives errors	<input checked="" type="checkbox"/>		<a href="#">Undo</a> <a href="#">Reset</a>

Save All Reset (This Tab) Undo (This Tab) Save and Exit Exit

The LINK cable wires must be connected to both units using terminals 37 and 38. The maximum length and cable type is described in Section 11.

### C.2.3 Single PGR-8800 Configuration with Current Sensor Input

The single line diagram in Fig. C.3 shows a local circuit breaker that does not have an available feedback auxiliary contact. The current-sensor inputs can be configured to verify that the local breaker successfully operated.

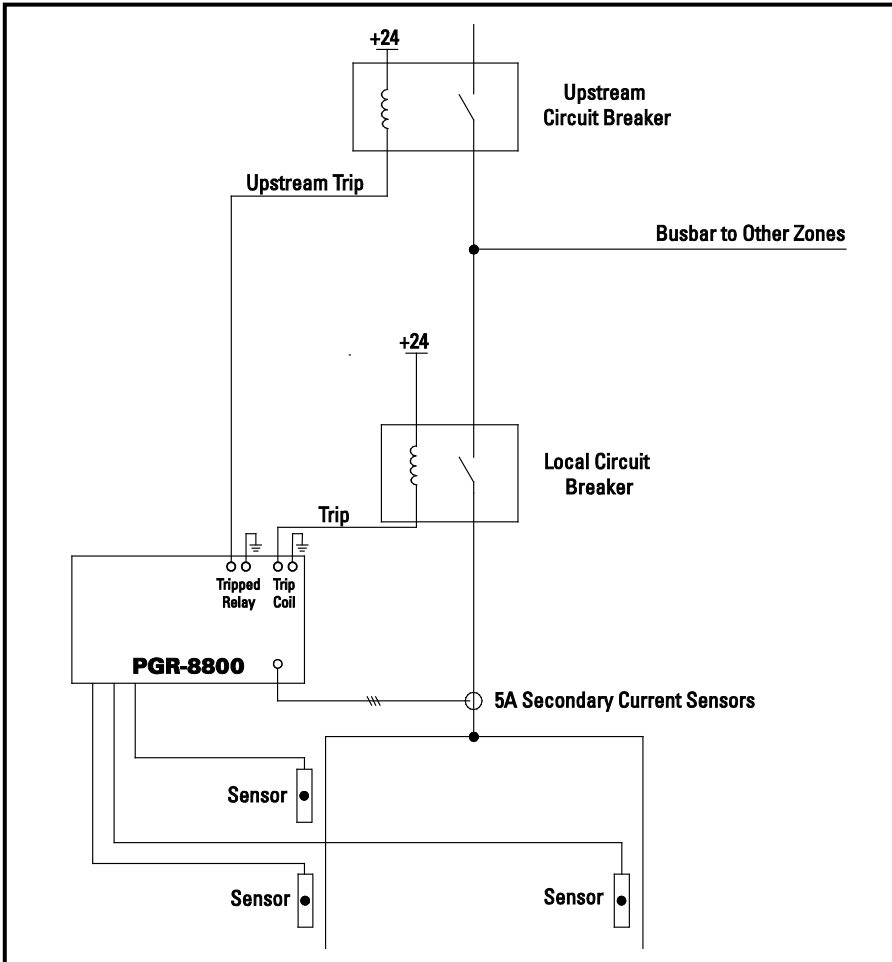

FIGURE C.3. Single PGR-8800 Configuration with Current Sensor Input.

**NOTE:** In this application, it is important that the current sensors are placed so that they only monitor current flowing through the local circuit breaker section. Otherwise, the upstream circuit breaker could trip even though the local circuit breaker cleared the fault.

**NOTE:** It is critical for the correct function of this application that three current sensors are connected.

In this case the current sensors are used as circuit feedback. This function is configured by selecting the Detect clearing failure by current check box.

General Optical Sensors Current Sensors **Inputs** Online Output Service Output Tripped Output Trip Coil Output Comms Advanced About

### Inputs

#### Inhibit Inputs

Function: Inhibit when low (switch closed) [Undo](#) [Reset](#)

#### Trip Inputs

Main function: Circuit breaker feedback [Undo](#) [Reset](#)  
*NOTE: Go to the Breaker Failure Options to setup detection of a CB failure*

Function: CB is closed when low (switch closed) [Undo](#) [Reset](#)

#### Reset Inputs

Function: Reset when low (switch closed) [Undo](#) [Reset](#)

#### Breaker Failure Options

Detect clearing failure by trip input  [Undo](#) [Reset](#)

Detect clearing failure by current  [Undo](#) [Reset](#)

Maximum local breaker clearing time  ms [Undo](#) [Reset](#)

**ERROR: Enable Clearing Failure on either Link (see Comms section) or on a relay output (Service or Tripped, see below) to communicate the clearing failure**

[Save All](#) [Reset \(This Tab\)](#) [Undo \(This Tab\)](#) [Save and Exit](#) [Exit](#)

The warning message refers to the output method, which has not yet been configured. Select the Detect clearing failure by current checkbox.

[General](#)
[Optical Sensors](#)
[Current Sensors](#)
[Inputs](#)
[Online Output](#)
[Service Output](#)
[Tripped Output](#)
[Trip Coil Output](#)
[Comms](#)
[Advanced](#)
[About](#)

## Current Sensors

### Setup

Rated nominal load current	<input type="text" value="4500"/>	A RMS on CT primary	<a href="#">Undo</a> <a href="#">Reset</a>
CT transformation ratio	<input type="text" value="5000"/>	A to 5 A RMS	<a href="#">Undo</a> <a href="#">Reset</a>
Current sensor mode	<input type="text" value="AC"/>		<a href="#">Undo</a> <a href="#">Reset</a>
Enable current inhibit	<input checked="" type="checkbox"/>		<a href="#">Undo</a> <a href="#">Reset</a>
Trip on Overcurrent 1	<input type="checkbox"/>		<a href="#">Undo</a> <a href="#">Reset</a>
Trip on Overcurrent 2	<input type="checkbox"/>		<a href="#">Undo</a> <a href="#">Reset</a>
Indicator blinks when above	<input type="text" value="100"/>	% of rated current	<a href="#">Undo</a> <a href="#">Reset</a>

### Trip Inhibit

Inhibit function disables trips below	<input type="text" value="50"/>	% of rated current	<a href="#">Undo</a> <a href="#">Reset</a>
---------------------------------------	---------------------------------	--------------------	--

Rated nominal load current and CT transformation ratio should be set correctly. The rest of the setup does not influence the clearing failure function.

[General](#)
[Optical Sensors](#)
[Current Sensors](#)
[Inputs](#)
[Online Output](#)
[Service Output](#)
[Tripped Output](#)
[Trip Coil Output](#)
[Comms](#)
[Advanced](#)
[About](#)

## Trip Coil Output



### Trip Coil Output

Trip Coil output function:	<input type="text" value="Indicate that the unit tripped"/>	<a href="#">Undo</a> <a href="#">Reset</a>
Circuit breaker type	<input type="text" value="Shunt coil (trips when powered)"/>	<a href="#">Undo</a> <a href="#">Reset</a>
Trip Coil Output Type	<input type="text" value="Pulsed"/>	<a href="#">Undo</a> <a href="#">Reset</a>
<i>WARNING: 20 A for 2 s, 10 A for 5 s, 750 mA continuous rating.</i>		
Circuit breaker pulse time	<input type="text" value="2"/> seconds	<a href="#">Undo</a> <a href="#">Reset</a>
Report an error if trip coil is not detected	<input checked="" type="checkbox"/>	<a href="#">Undo</a> <a href="#">Reset</a>

[General](#)
[Optical Sensors](#)
[Current Sensors](#)
[Inputs](#)
[Online Output](#)
[Service Output](#)
[Tripped Output](#)
[Trip Coil Output](#)
[Comms](#)
[Advanced](#)
[About](#)

## Tripped Output



### Tripped Output

Tripped output function:	<input type="text" value="Trip upstream breaker on clearing failure"/>	<a href="#">Undo</a> <a href="#">Reset</a>
<i>NOTE: The LED on the overlay will still indicate if the relay has tripped.</i>		

The relay output is configured as described in Section C.2.1. The warning message will disappear after selecting an output.

**C.2.4 Dual PGR-8800 Configuration using Link Interface and Current Sensor Input**

The single line diagram in Fig. C.4 shows an incoming feeder with a circuit breaker, a bus bar, and a zone protected with an upstream PGR-8800. The upstream circuit breaker can be tripped in the event of a local circuit breaker failure.

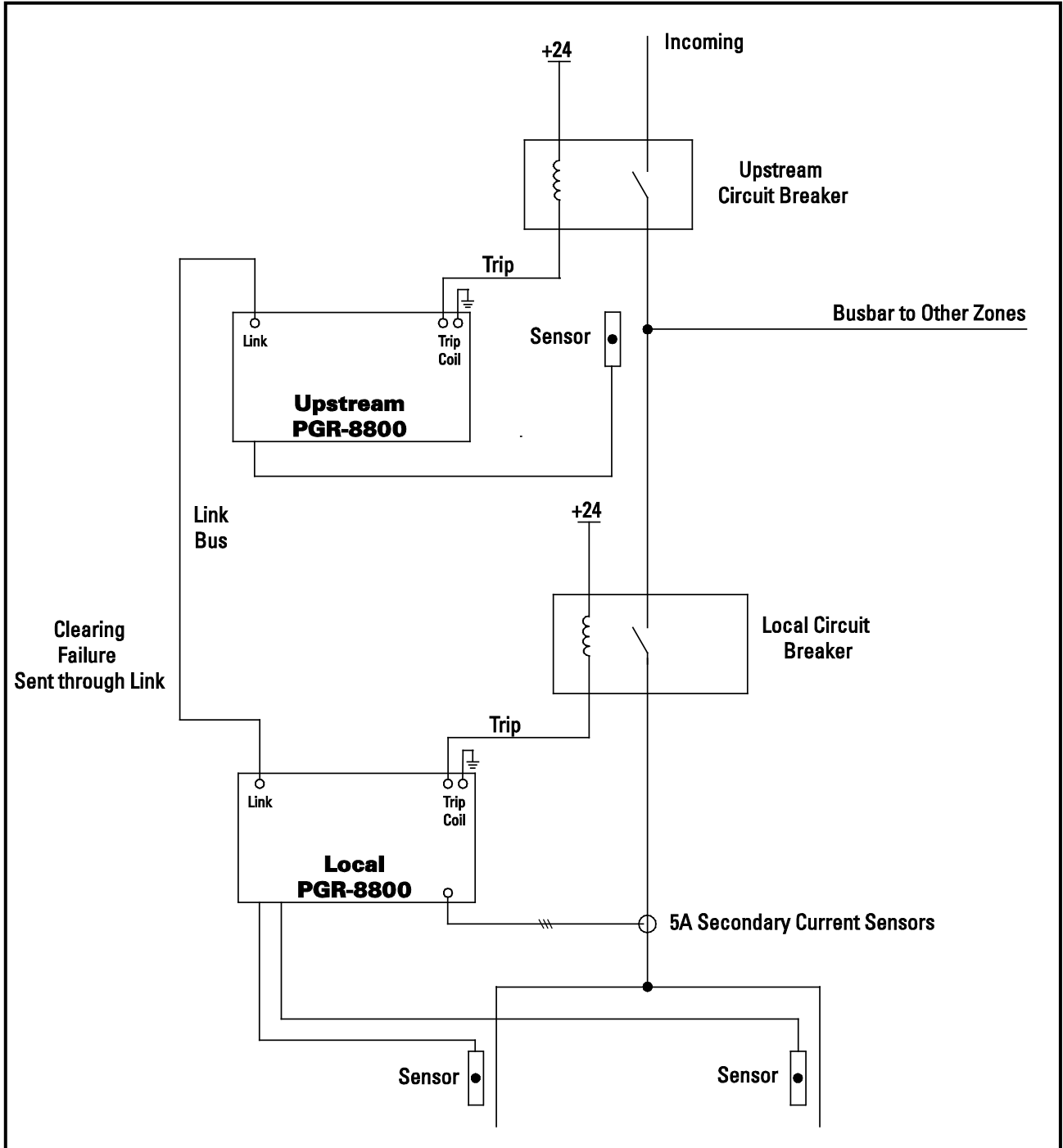

FIGURE C.4. Dual PGR-8800 Configuration using Link Interface and Current Sensor Input.

Configure clearing failure as in Section C.2.3, and output as in Section C.2.2.

In this case the current sensors are used as circuit feedback. This function is configured by selecting the Detect clearing failure by current check box.

[General](#)
[Optical Sensors](#)
[Current Sensors](#)
[Inputs](#)
[Online Output](#)
[Service Output](#)
[Tripped Output](#)
[Trip Coil Output](#)
[Comms](#)
[Advanced](#)
[About](#)

## Inputs

### Inhibit Inputs

Function:  [Undo](#) [Reset](#)

### Trip Inputs

Main function:  [Undo](#) [Reset](#)

Function:  [Undo](#) [Reset](#)

Trip on this input can be inhibited  [Undo](#) [Reset](#)

### Reset Inputs

Function:  [Undo](#) [Reset](#)

### Breaker Failure Options

Detect clearing failure by trip input  [Undo](#) [Reset](#)

Detect clearing failure by current  [Undo](#) [Reset](#)

Maximum local breaker clearing time  ms [Undo](#) [Reset](#)

**ERROR: Enable Clearing Failure on either Link (see Comms section) or on a relay output (Service or Tripped, see below) to communicate the clearing failure**

The warning message refers to the output method, which has not yet been configured.

Select the Detect clearing failure by current checkbox.

[General](#)
[Optical Sensors](#)
[Current Sensors](#)
[Inputs](#)
[Online Output](#)
[Service Output](#)
[Tripped Output](#)
[Trip Coil Output](#)
[Comms](#)
[Advanced](#)
[About](#)

## Current Sensors

### Setup

Rated nominal load current  A RMS on CT primary [Undo](#) [Reset](#)

CT transformation ratio  A to 5 A RMS [Undo](#) [Reset](#)

Current sensor mode  [Undo](#) [Reset](#)

Enable current inhibit  [Undo](#) [Reset](#)

Trip on Overcurrent 1  [Undo](#) [Reset](#)

Trip on Overcurrent 2  [Undo](#) [Reset](#)

Indicator blinks when above  % of rated current [Undo](#) [Reset](#)

### Trip Inhibit

Inhibit function disables trips below  % of rated current [Undo](#) [Reset](#)

The Rated Nominal load current and CT transformation ratio should be set correctly. The rest of the setup does not influence the clearing failure function.

Configure the local PGR-8800 to use the Link Interface. The unit address must be unique, and the number of linked units in the system must be configured.

Select Clearing Failure to allow the PGR-8800 to send the Link alarm signal to the upstream PGR-8800.



The Received Link alarm signal trips this unit is not selected. This makes it possible to have several downstream units trip a common upstream unit without tripping each other.

General Optical Sensors Current Sensors Inputs Online Output Service Output Tripped Output Trip Coil Output **Comms** Advanced About

## Comms

### Link Interface

Is used for  [Undo](#) [Reset](#)

*NOTE: Waveform capture cannot be used when the Link feature is selected.*  
*NOTE: Changes to this parameter will reboot the unit to complete the change.*

### Link Configuration

Unit address	<input type="text" value="1"/>	Must be unique, lowest must be 1	<a href="#">Undo</a> <a href="#">Reset</a>
Number of linked units in the system	<input type="text" value="2"/>	Report an error if any unit is missing.	<a href="#">Undo</a> <a href="#">Reset</a>
Send Link alarm signal on	<input type="text" value="Clearing failure"/>		<a href="#">Undo</a> <a href="#">Reset</a>
Received Link alarm signal trips this unit	<input type="checkbox"/>		<a href="#">Undo</a> <a href="#">Reset</a>
Link sends and receives the user interface	<input checked="" type="checkbox"/>		<a href="#">Undo</a> <a href="#">Reset</a>
Link sends and receives errors	<input checked="" type="checkbox"/>		<a href="#">Undo</a> <a href="#">Reset</a>

The unit controlling the upstream circuit breaker is configured to Receive Link alarm signal trips this unit. The upstream PGR-8800 is configured to send a Link alarm signal, but in the current configuration, this has no effect as the other downstream units are not configured to receive the Link alarm.

General Optical Sensors Current Sensors Inputs Online Output Service Output Tripped Output Trip Coil Output **Comms** Advanced About

## Comms

### Link Interface

Is used for  [Undo](#) [Reset](#)

*NOTE: Waveform capture cannot be used when the Link feature is selected.*  
*NOTE: Changes to this parameter will reboot the unit to complete the change.*

### Link Configuration

Unit address	<input type="text" value="2"/>	Must be unique, lowest must be 1	<a href="#">Undo</a> <a href="#">Reset</a>
Number of linked units in the system	<input type="text" value="2"/>	Report an error if any unit is missing.	<a href="#">Undo</a> <a href="#">Reset</a>
Send Link alarm signal on	<input type="text" value="Trip"/>		<a href="#">Undo</a> <a href="#">Reset</a>
Received Link alarm signal trips this unit	<input checked="" type="checkbox"/>		<a href="#">Undo</a> <a href="#">Reset</a>
Link sends and receives the user interface	<input checked="" type="checkbox"/>		<a href="#">Undo</a> <a href="#">Reset</a>
Link sends and receives errors	<input checked="" type="checkbox"/>		<a href="#">Undo</a> <a href="#">Reset</a>

The link cable must be connected to both units, using terminals 37 and 38. The maximum length and cable type is described in the Section 14.

### C.2.5 Configuration of Multiple Inputs and Outputs

It is possible to combine both input and output methods. For example, it is possible to use both the current sensor inputs and a circuit breaker auxiliary signal to detect a clearing failure. The relay will send the upstream trip signal if any of the criteria is met.

Likewise, it is possible to configure several outputs to react on a circuit breaker failure. The relay will simultaneously energize the two possible output relays and the Link Alarm signal, if so configured.

**C.2.6 Tripping Common Upstream Circuit Breaker from Several Zones using PGA-1100**

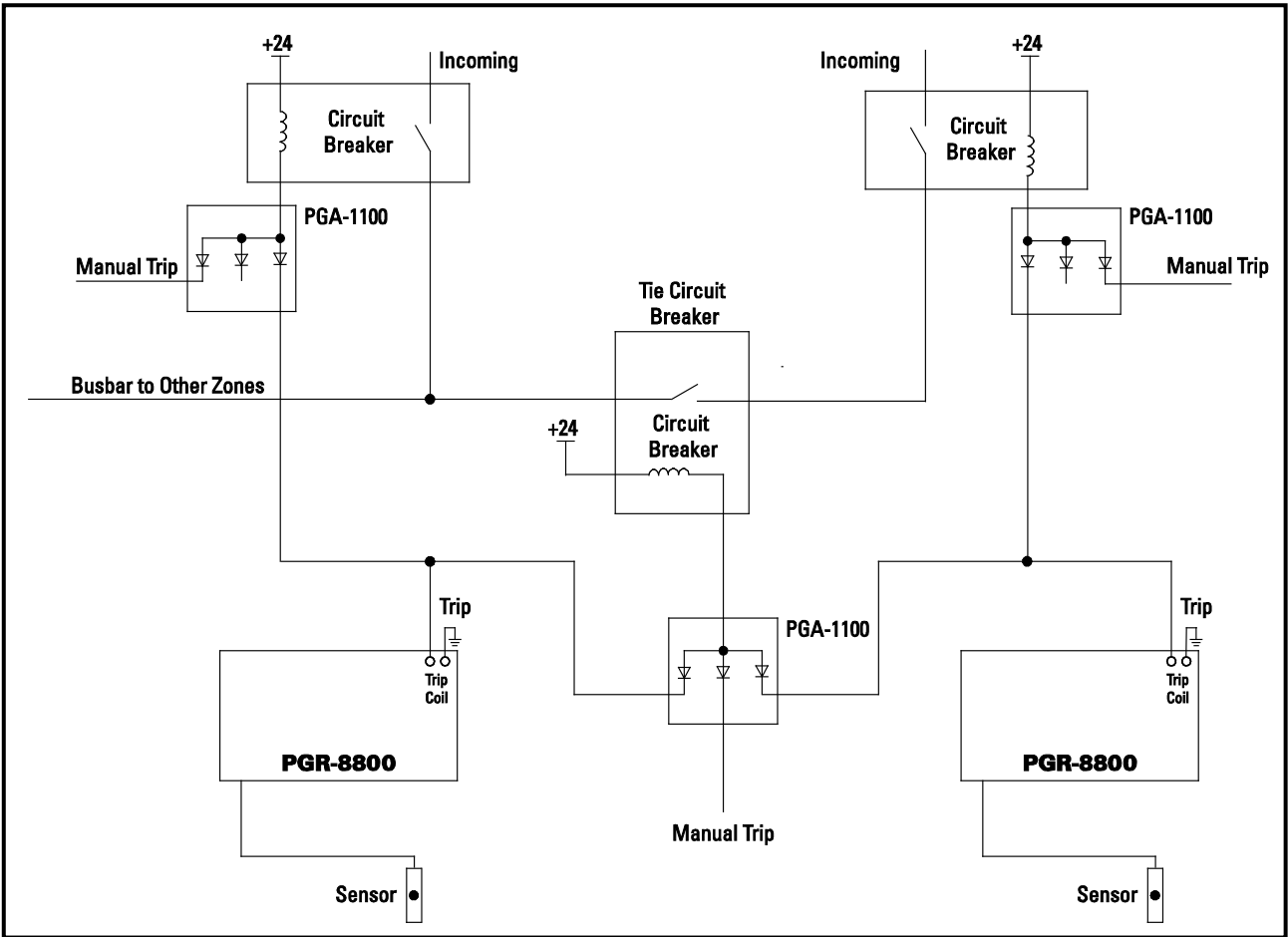

Fig. C.5. Tripping Common Upstream Circuit Breaker from Several Zones using PGA-1100.

Fig C.5 shows two incoming feeders and a tie breaker. Each incoming circuit breaker trip coil is connected to an independent PGR-8800 through a PGA-1100 Diode Logic Unit. The tie breaker trip coil is also connected to the trip coil of each PGR-8800 through a separate PGA-1100.

If a trip occurs at either PGR-8800, both the tie circuit breaker and the corresponding circuit breaker will trip.

**APPENDIX D SYSTEM PARAMETERS AND SETUP RECORD<sup>1</sup>**

GENERAL INSTALLATION SETTINGS	MIN	DEFAULT	MAX	UNIT	COMMENTS
Date installed					
Operator					
Front panel trip level (1-9)	1	9	9		
Comment 1					
Comment 2					
PARAMETER AND SETTINGS	MIN	DEFAULT	MAX	UNIT	PROGRAM SELECTION
<b>GENERAL</b>					
<b>System Name</b>					
Description of this unit		PGR-8800 Arc-Flash Relay			
<b>Date and Time</b>					
Synchronize to PC clock		Disabled			<input type="checkbox"/> Enabled <input type="checkbox"/> Disabled
<b>OPTICAL SENSORS</b>					
<b>Common Settings</b>					
Arc Detection time before tripping	0 (effective 0.8)	1	20,000	ms	
LED flashes green when above	50	75	90	% Trip Level	
Sensor Sensitivity		Standard			<input type="checkbox"/> Standard <input type="checkbox"/> Sensitive
<b>Sensor 1</b>					
Sensor description		Sensor 1			
Ignore sensor check errors		Disabled			<input type="checkbox"/> Enabled <input type="checkbox"/> Disabled
Change configuration		No change			<input type="checkbox"/> No change <input type="checkbox"/> No sensor expected <input type="checkbox"/> Sensor expected
<b>Sensor 2</b>					
Sensor description		Sensor 2			
Ignore sensor check errors		Disabled			<input type="checkbox"/> Enabled <input type="checkbox"/> Disabled
Change configuration		No change			<input type="checkbox"/> No change <input type="checkbox"/> No sensor expected <input type="checkbox"/> Sensor expected
<b>Sensor 3</b>					
Sensor description		Sensor 3			
Ignore sensor check errors		Disabled			<input type="checkbox"/> Enabled <input type="checkbox"/> Disabled
Change configuration		No change			<input type="checkbox"/> No change <input type="checkbox"/> No sensor expected <input type="checkbox"/> Sensor expected
<b>Sensor 4</b>					
Sensor description		Sensor 4			
Ignore sensor check errors		Disabled			<input type="checkbox"/> Enabled <input type="checkbox"/> Disabled
Change configuration		No change			<input type="checkbox"/> No change <input type="checkbox"/> No sensor expected <input type="checkbox"/> Sensor expected
<b>Sensor 5</b>					
Sensor description		Sensor 5			
Ignore sensor check errors		Disabled			<input type="checkbox"/> Enabled <input type="checkbox"/> Disabled
Change configuration		No change			<input type="checkbox"/> No change <input type="checkbox"/> No sensor expected <input type="checkbox"/> Sensor expected
<b>Sensor 6</b>					
Sensor description		Sensor 6			
Ignore sensor check errors		Disabled			<input type="checkbox"/> Enabled <input type="checkbox"/> Disabled
Change configuration		No change			<input type="checkbox"/> No change <input type="checkbox"/> No sensor expected <input type="checkbox"/> Sensor expected

PARAMETER AND SETTINGS	MIN	DEFAULT	MAX	UNIT	PROGRAM SELECTION
<b>Local Sensor</b>					
Sensor Description		Local Sensor			
Local sensor causes trip		Disabled			<input type="checkbox"/> Enabled <input type="checkbox"/> Disabled
<b>CURRENT SENSORS</b>					
<b>Setup</b>					
Rated nominal load current	5	100	100,000	Amperes RMS on CT Primary	
CT transformation ratio	5	100	100,000	Ratio x: 5 A RMS	
Current sensor mode		AC			<input type="checkbox"/> AC <input type="checkbox"/> DC
Enable current inhibit		Disabled			<input type="checkbox"/> Enabled <input type="checkbox"/> Disabled
Trip on Overcurrent 1		Disabled			<input type="checkbox"/> Enabled <input type="checkbox"/> Disabled
Trip on Overcurrent 2		Disabled			<input type="checkbox"/> Enabled <input type="checkbox"/> Disabled
<b>Trip Inhibit (if enabled)</b>					
Inhibit function disables trips below	10	50	1,000	%	
<b>Overcurrent 1 Protection (if enabled)</b>					
Trip on current above	150	150	1,000	% of rated current	
Time delay	1	500	20,000	ms	
<b>Overcurrent 2 Protection (if enabled)</b>					
Trip on current above	150	150	1,000	% of rated current	
Time delay	1	500	20,000	ms	
<b>INPUTS</b>					
<b>Inhibit Inputs</b>					
Function		Inhibit when low (switch closed)			<input type="checkbox"/> Inhibit when low (switch closed) <input type="checkbox"/> Inhibit when low with circuit check <input type="checkbox"/> Inhibit when not low (switch open) <input type="checkbox"/> Disabled
<b>Trip Inputs</b>					
Main function		Trip input			<input type="checkbox"/> Trip input <input type="checkbox"/> Circuit breaker feedback <input type="checkbox"/> Disabled
Function (with Trip Input main function)		Trip the output when low (switch closed)			<input type="checkbox"/> Trip the output when low (switch closed) <input type="checkbox"/> Trip the output when low with circuit check <input type="checkbox"/> Trip the output when not low (switch open)
Function (with circuit breaker feedback)		CB is closed when low (switch closed)			<input type="checkbox"/> CB is closed when low (switch closed) <input type="checkbox"/> CB is closed when low with circuit check <input type="checkbox"/> CB is closed when not low (switch open)
Trip on this input can be inhibited		Disabled			<input type="checkbox"/> Enabled <input type="checkbox"/> Disabled
<b>Reset Inputs</b>					
Function		Reset when low (switch closed)			<input type="checkbox"/> Reset when low (switch closed) <input type="checkbox"/> Reset when low with circuit check <input type="checkbox"/> Reset when not low (switch open) <input type="checkbox"/> Disabled

PARAMETER AND SETTINGS	MIN	DEFAULT	MAX	UNIT	PROGRAM SELECTION
<b>Breaker Failure Options</b>					
Detect clearing failure by trip input		Disabled			<input type="checkbox"/> Enabled <input type="checkbox"/> Disabled
Detect clearing failure by current		Disabled			<input type="checkbox"/> Enabled <input type="checkbox"/> Disabled
<b>OUTPUTS</b>					
<b>Trip Coil Output</b>					
Trip Coil output function		Indicate that the unit tripped			<input type="checkbox"/> Indicate that the unit tripped <input type="checkbox"/> Trip Zone <input type="checkbox"/> Current Detected
Circuit breaker type		Shunt Coil (opens when powered)			<input type="checkbox"/> Shunt Coil (opens when powered) <input type="checkbox"/> Undervoltage coil (closed when powered)
Circuit breaker pulse time	1	1	5	seconds	
Output Operating Mode (Trip Zone only)		Non-fail-safe			<input type="checkbox"/> Non-fail-safe <input type="checkbox"/> Fail-safe
Light Sensor x trips this zone (Trip Zone only)		1,2,3,4,5,6			<input type="checkbox"/> Sensor 1 <input type="checkbox"/> Sensor 2 <input type="checkbox"/> Sensor 3 <input type="checkbox"/> Sensor 4 <input type="checkbox"/> Sensor 5 <input type="checkbox"/> Sensor 6
Trip Input trips this zone (Trip Zone only)		Enabled			<input type="checkbox"/> Enabled <input type="checkbox"/> Disabled
Link Trip trips this zone (Trip Zone only)		Enabled			<input type="checkbox"/> Enabled <input type="checkbox"/> Disabled
Trip in service mode		Disabled			<input type="checkbox"/> Enabled <input type="checkbox"/> Disabled
Report an error if trip coil is not detected		Enabled			<input type="checkbox"/> Enabled <input type="checkbox"/> Disabled
<b>Online Output</b>					
Online output function		Indicate Online Operation			<input type="checkbox"/> Indicate Online Operation <input type="checkbox"/> Trip Zone <input type="checkbox"/> Trip Zone and Online Operation <input type="checkbox"/> Current Detected
Online Output type		Continuous			<input type="checkbox"/> Continuous <input type="checkbox"/> Pulsed
Circuit breaker pulse time	1	1	5	seconds	
Output Operating Mode (Trip Zone only)		Non-fail-safe			<input type="checkbox"/> Non-fail-safe <input type="checkbox"/> Fail-safe
Light Sensor x trips this zone (Trip Zone only)		1,2,3,4,5,6			<input type="checkbox"/> Sensor 1 <input type="checkbox"/> Sensor 2 <input type="checkbox"/> Sensor 3 <input type="checkbox"/> Sensor 4 <input type="checkbox"/> Sensor 5 <input type="checkbox"/> Sensor 6
Trip Input trips this zone (Trip Zone only)		Enabled			<input type="checkbox"/> Enabled <input type="checkbox"/> Disabled
Link Trip trips this zone (Trip Zone only)		Enabled			<input type="checkbox"/> Enabled <input type="checkbox"/> Disabled
<b>Service Output</b>					
Service output function		Indicate Service mode			<input type="checkbox"/> Indicate Service mode <input type="checkbox"/> Follow trip coil output <input type="checkbox"/> Trip upstream breaker on clearing failure <input type="checkbox"/> Trip Zone <input type="checkbox"/> Current Detected
Online Output type		Continuous			<input type="checkbox"/> Continuous <input type="checkbox"/> Pulsed
Circuit breaker pulse time	1	1	5	seconds	
Output Operating Mode (Trip Zone only)		Non-fail-safe			<input type="checkbox"/> Non-fail-safe <input type="checkbox"/> Fail-safe
Light Sensor x trips this zone (Trip Zone only)		1,2,3,4,5,6			<input type="checkbox"/> Sensor 1 <input type="checkbox"/> Sensor 2 <input type="checkbox"/> Sensor 3 <input type="checkbox"/> Sensor 4 <input type="checkbox"/> Sensor 5 <input type="checkbox"/> Sensor 6
Trip Input trips this zone (Trip Zone only)		Enabled			<input type="checkbox"/> Enabled <input type="checkbox"/> Disabled
Link Trip trips this zone (Trip Zone only)		Enabled			<input type="checkbox"/> Enabled <input type="checkbox"/> Disabled

<b>Tripped Output</b>					
Tripped output function		Indicate that the unit tripped			<input type="checkbox"/> Indicate that the unit tripped <input type="checkbox"/> Follow trip coil output <input type="checkbox"/> Trip upstream breaker on clearing failure <input type="checkbox"/> User-defined pulse on trip <input type="checkbox"/> Trip Zone <input type="checkbox"/> Current Detected
Online Output type		Continuous			<input type="checkbox"/> Continuous <input type="checkbox"/> Pulsed
Circuit breaker pulse time	1	1	5	seconds	
Output Operating Mode (Trip Zone only)		Non-fail-safe			<input type="checkbox"/> Non-fail-safe <input type="checkbox"/> Fail-safe
Light Sensor x trips this zone (Trip Zone only)		1,2,3,4,5,6			<input type="checkbox"/> Sensor 1 <input type="checkbox"/> Sensor 2 <input type="checkbox"/> Sensor 3 <input type="checkbox"/> Sensor 4 <input type="checkbox"/> Sensor 5 <input type="checkbox"/> Sensor 6
Trip Input trips this zone (Trip Zone only)		Enabled			<input type="checkbox"/> Enabled <input type="checkbox"/> Disabled
Link Trip trips this zone (Trip Zone only)		Enabled			<input type="checkbox"/> Enabled <input type="checkbox"/> Disabled
<b>COMMS</b>					
<b>Link Interface</b>					
Is used for		Nothing			<input type="checkbox"/> Nothing <input type="checkbox"/> Linking multiple units <input type="checkbox"/> MODBUS
<b>Link Configuration (if enabled)</b>					
Unit address	1	1	4	Unit address	
Number of linked units in the system	1	1	4		
Send Link alarm signal on		Trip			<input type="checkbox"/> Never <input type="checkbox"/> Light above threshold <input type="checkbox"/> Trip <input type="checkbox"/> Clearing failure
Received Link alarm signal trips this unit		Enabled			<input type="checkbox"/> Enabled <input type="checkbox"/> Disabled
Link sends and receives the user interface		Enabled			<input type="checkbox"/> Enabled <input type="checkbox"/> Disabled
Link sends and receives errors		Enabled			<input type="checkbox"/> Enabled <input type="checkbox"/> Disabled
<b>MODBUS Configuration (if enabled)</b>					
Unit address	1	1	247	Unit address	
Baud rate	1,200	19,200	19,200		<input type="checkbox"/> 1200 <input type="checkbox"/> 2400 <input type="checkbox"/> 4800 <input type="checkbox"/> 9600 <input type="checkbox"/> 19200
Parity		Even			<input type="checkbox"/> None <input type="checkbox"/> Odd <input type="checkbox"/> Even
Allows writes via MODBUS		Disabled			<input type="checkbox"/> Enabled <input type="checkbox"/> Disabled
<b>ADVANCED</b>					
<b>Service Mode Options</b>					
Return to ONLINE mode when USB is unplugged		Disabled			<input type="checkbox"/> Enabled <input type="checkbox"/> Disabled
Trip in Service mode		Disabled			<input type="checkbox"/> Enabled <input type="checkbox"/> Disabled
<b>Logging</b>					
Enable data logging		Enabled			<input type="checkbox"/> Enabled <input type="checkbox"/> Disabled
Enabled waveform capture		Disabled			<input type="checkbox"/> Enabled <input type="checkbox"/> Disabled

PARAMETER AND SETTINGS	MIN	DEFAULT	MAX	UNIT	PROGRAM SELECTION
<b>Internal Drives</b>					
Reset configuration drive to factory default		Disabled			<input type="checkbox"/> Enabled <input type="checkbox"/> Disabled
Reset log drive to factory default		Disabled			<input type="checkbox"/> Enabled <input type="checkbox"/> Disabled
<b>Configuration</b>					
Reset configuration to factory defaults		Disabled			<input type="checkbox"/> Enabled <input type="checkbox"/> Disabled

**NOTES:**
<sup>1</sup> Firmware reference 1.03.16.



**APPENDIX E  
PGR-8800 REVISION HISTORY**

<b>MANUAL RELEASE DATE</b>	<b>MANUAL REVISION</b>	<b>HARDWARE REVISION (REVISION NUMBER ON PRODUCT LABEL)</b>	<b>FIRMWARE REVISION</b>
May 29, 2023	3-D-052923	2.4 2.3	1.03.17 1.03.16 1.03.15 1.03.13
April 8, 2016	3-C-040816	2.3	1.03.10
September 22, 2015	3-B-092215	2.3 2.2	
November 29, 2013	3-A-112913	2.1	
December 14, 2012	2	2	
			1.03.09

**MANUAL REVISION HISTORY**

**Revision 3-D-052923**

**Section 8**

Additional functions added to the ONLINE, SERVICE, TRIPPED, and TRIP COIL outputs.

**Section 14**

ABS Type approval removed.

**General**

Updates to several sections.

**Revision 3-C-040816**

**Section 4**

Fig. 8 updated.

**Section 12**

Section 12.4 added.

**Section 14**

RCM certification added.

**Revision 3-B-092215**

**Section 4**

Sensor input and fiber sensor note added.

**Section 11**

MODBUS configuration program note added.

**Section 14**

CSA certification added. ABS and DNV type approval added.

Operating temperature maximum range increased.

**Section 15**

Updated ordering information. Removed PGA-LS25 sensor.

**Revision 3-A-112913**

**Section 3**

Updated power supply information.

**Section 4**

Updated Figs. 6 and 8.

**Section 14**

Added EMC test specifications.

**Section 15**

Updated ordering information.

**Appendix B**

Updated Modbus database table.

**Appendix E**

Added revision history.

**Revision 2**

Significant manual update for most sections. Added UL certification.

**HARDWARE REVISION HISTORY****Hardware Revision 2.4**

Additional flash memory support.

**Hardware Revision 2.3**

Operating and storage temperature range improved to -40 to 85°C (-40°F to 185°F) from -25 to 70°C (-13°F to 158°F).

**Hardware Revision 2.2**

CSA certification and marine type testing (ABS, DNV).

**Hardware Revision 2.1**

Combines CE and UL conformance in the same PCB revision.

No changes in functionality, performance, or components.

**Hardware Revision 2**

Changed protection components for UL conformance.

Added screw fasteners to current sensor inputs.

**FIRMWARE REVISION HISTORY****Firmware Revision 1.03.17**

Added low-voltage limit and hysteresis when powered by DC supply or external battery.

**Firmware Revision 1.03.16**

Added pulsed or continuous output type for Online, Service, and Tripped outputs.

Improved Modbus functionality.

Added additional Service mode options.

**Firmware Revision 1.03.15**

Added independent trip zones for Online, Service, and Tripped outputs.

Added Current Detected output function.

Data logging enabled by default.

**Firmware Revision 1.03.14**

Added optical sensor sensitivity mode.

**Firmware Revision 1.03.13**

Added additional Tripped Output functions.

**Firmware Revision 1.03.10**

Added Internet Explorer support in event viewer.

**Firmware Revision 1.03.09**

Removed trip terminal from Link Sharing.