

FIBER-OPTIC SENSOR
CABLE APPROXIMATELY
30ft. LONG INCLUDED

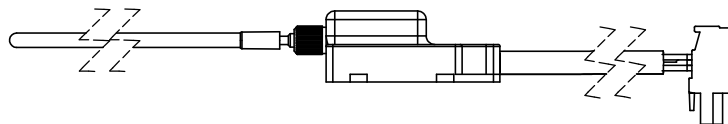

UNLESS NOTED OTHERWISE
DIMENSIONS ARE IN INCHES
TOLERANCES:
TWO PLACE DECIMAL ±0.05
NOT DRAWN TO SCALE

MATERIAL	
NAME	DATE
DRAWN BY J.MOLER	03/31/23

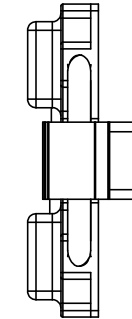
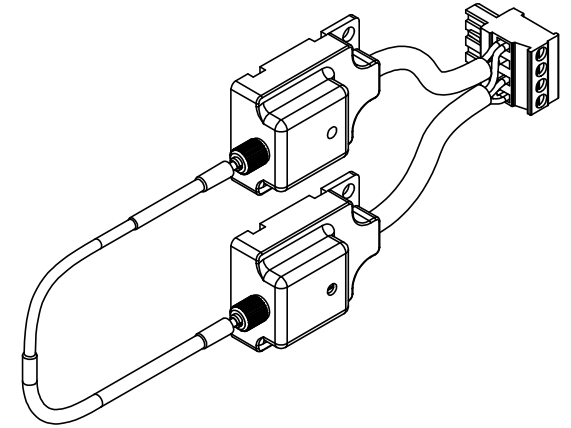
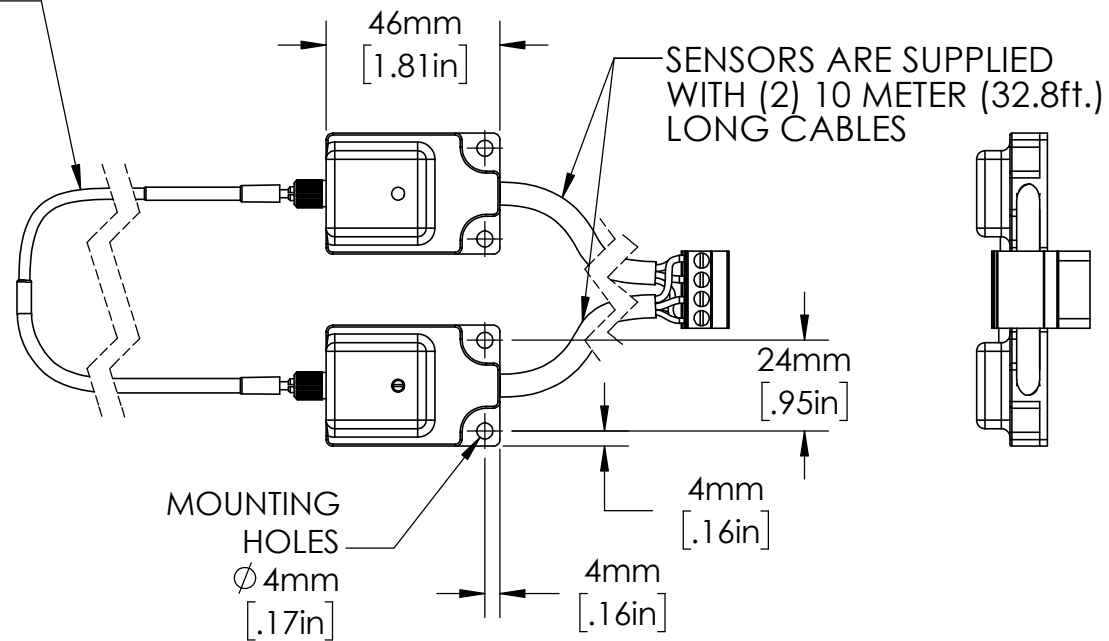
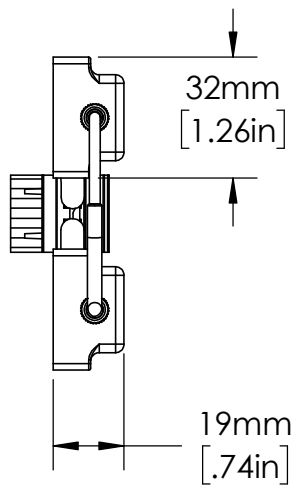

DESCRIPTION: ARC FLASH DETECTION
FIBER-OPTIC SENSOR
RELAY ACCESSORY

PART NUMBER: PGA-LS30 SERIES REV A

WEIGHT: SHEET 1 OF 1