

THIS DRAWING AND THE INFORMATION CONTAINED WITHIN IT ARE CONFIDENTIAL AND MAY NOT BE COPIED OR DISCLOSED WITHOUT THE WRITTEN PERMISSION OF LITTELFUSE.

REVISIONS				
ZONE	REV.	DESCRIPTION	DATE	APPROVED
	A	GCF#524714 INITIAL RELEASE	NOV./25/2021	D. ZHANG

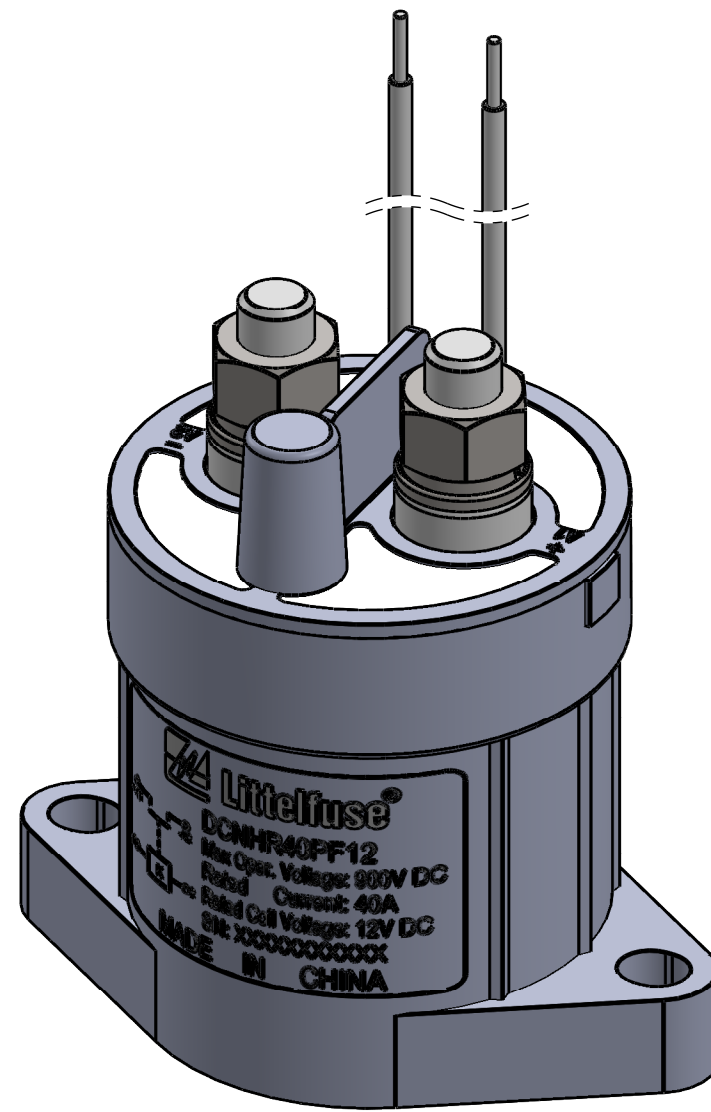

CIRCUIT SCHEMATIC DIAGRAM

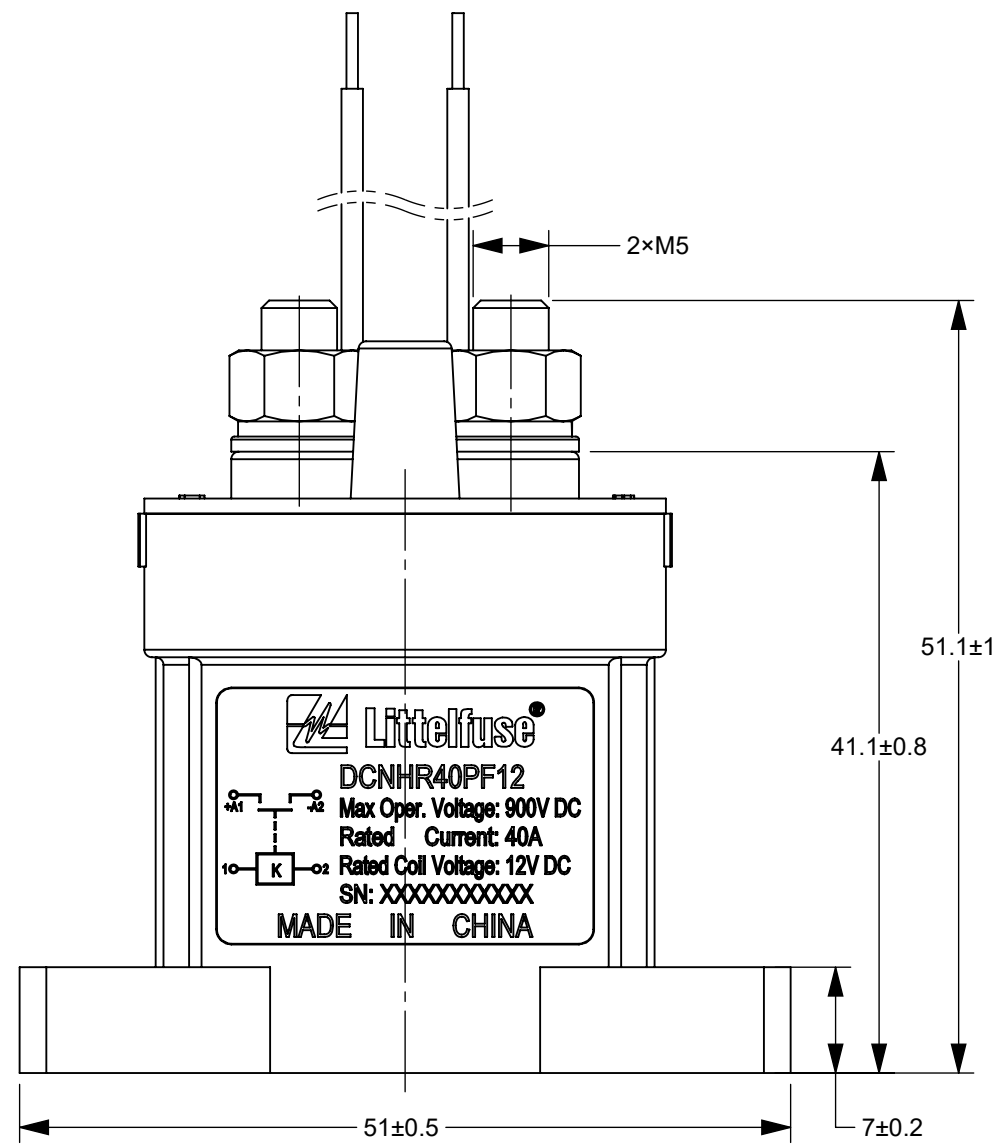
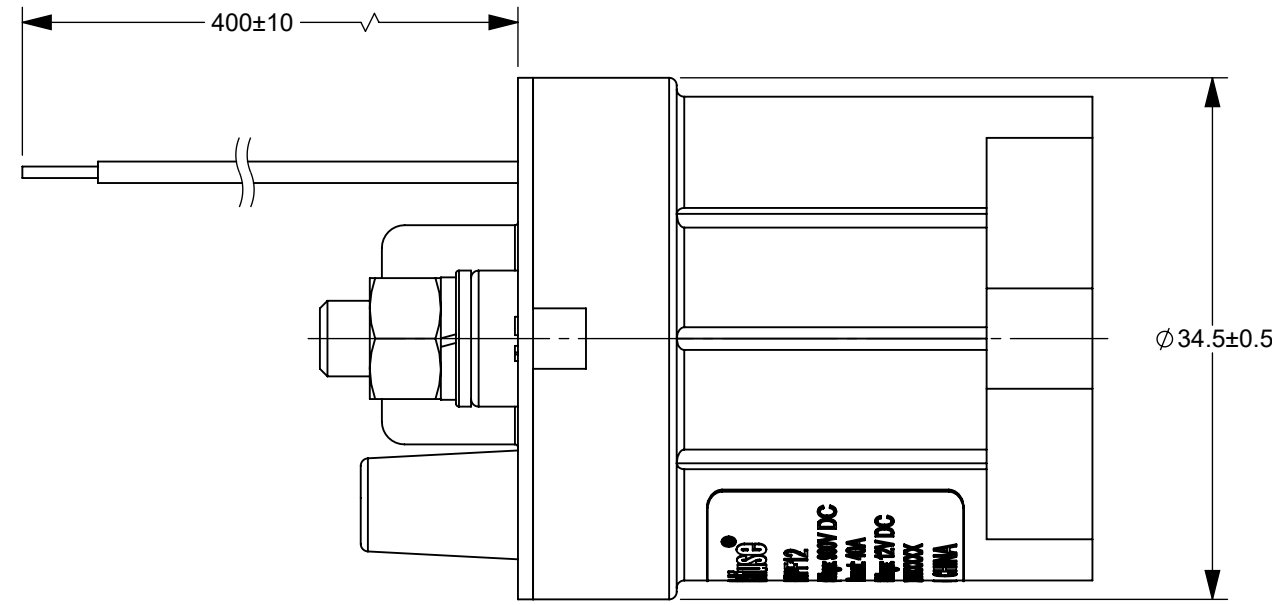
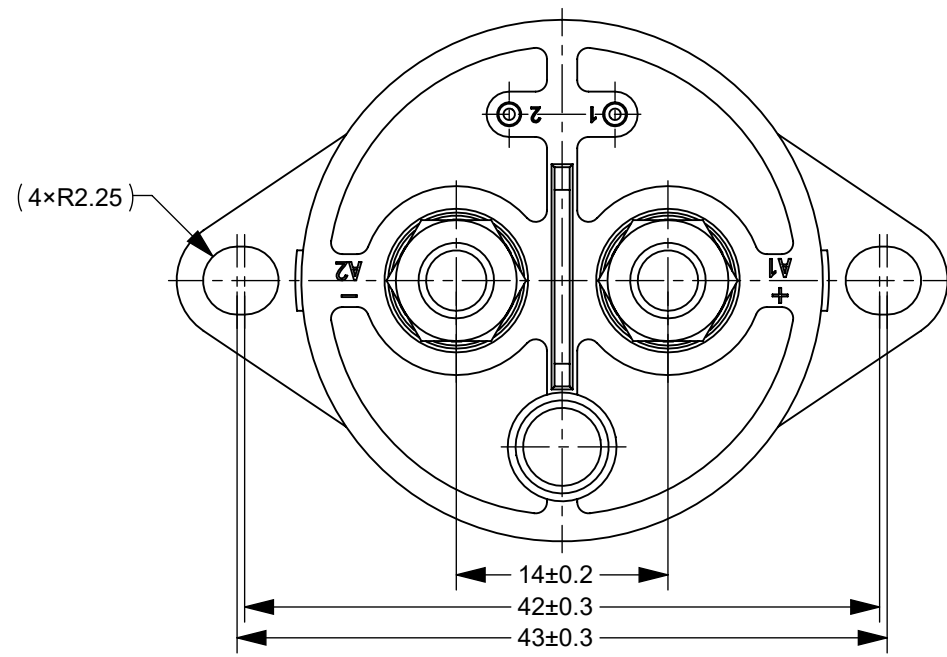
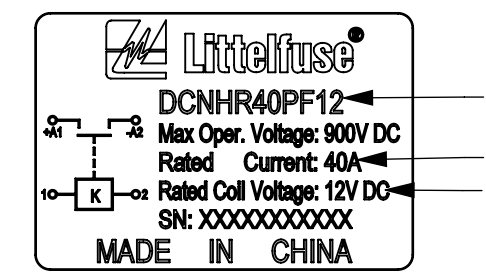
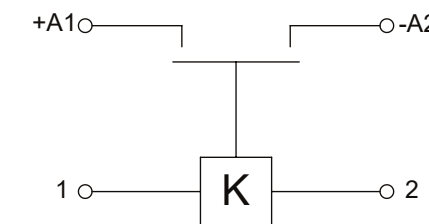

NAME PLATE

TABLE 1

PN	DCNHR40PF12 DCNHR30PF12 DCNHR20PF12	DCNHR40PF24 DCNHR30PF24 DCNHR20PF24	DCNHR40PF48 DCNHR30PF48 DCNHR20PF48
MAX OPER. VOLTAGE	900V DC		
RATED CONTACT CURRENT	DCNHR40PF SERIES: 40A DCNHR30PF SERIES: 30A DCNHR20PF SERIES: 20A		
COIL RATED VOLTAGE	12V DC	24V DC	48V DC
OPERATING VOLTAGE IN COLD STATE @ (23±5)°C	OPERATE	9V DC MAX	18V DC MAX
	RELEASE	1V DC MIN	2V DC MIN
OPERATE TIME	25ms MAX		
CONTACT BOUNCE TIME	7ms MAX		
RELEASE TIME	12ms MAX		
MAIN CONTACT RESISTANCE(@ 20A)	≤2mΩ		
INSULATION RESISTANCE @ 500 V (INITIAL)	≥100 MΩ		
DIELECTRIC STRENGTH (LEAKAGE CURRENT≤1 mA)	2200V AC, 1 MINUTE		
ELECTRIC LIFE	DCNHR40PF SERIES	6000 CYCLES (40A @ 450V DC)	
	DCNHR30PF SERIES	75000 CYCLES (30A @ 450V DC)	
	DCNHR20PF SERIES	10000 CYCLES (20A @ 450V DC)	
MECHANICAL LIFE(NO LOAD, CYCLES)	200, 000		
WORKING DUTY	CONTINUOUS		

TABLE 2 (CONFIGURATION)

NO.	PN	"A"	"B"	"C"	REMARK
1	DCNHR40PF12	DCNHR40PF12	Rated Current: 40A	Coil Voltage: 12V DC	
2	DCNHR40PF24	DCNHR40PF24		Coil Voltage: 24V DC	
3	DCNHR40PF48	DCNHR40PF48		Coil Voltage: 48V DC	
4	DCNHR30PF12	DCNHR30PF12	Rated Current: 30A	Coil Voltage: 12V DC	
5	DCNHR30PF24	DCNHR30PF24		Coil Voltage: 24V DC	
6	DCNHR30PF48	DCNHR30PF48		Coil Voltage: 48V DC	
7	DCNHR20PF12	DCNHR20PF12	Rated Current: 20A	Coil Voltage: 12V DC	
8	DCNHR20PF24	DCNHR20PF24		Coil Voltage: 24V DC	
9	DCNHR20PF48	DCNHR20PF48		Coil Voltage: 48V DC	

- NOTES:
 1. ALL DIMENSIONS ARE REFERENCE ONLY.
 2. SEE TABLE 2 FOR NAME PLATE AND PNs
 3. PRODUCT TYPE: SPST-NO, POLAR CONTACTOR.
 4. MATERIALS AND FINISH:
 4.1 HOUSING: THERMOPLASTIC PLASTICS.
 4.2 CONTACTS: COPPER ALLOY.
 4.3 CONTACT STUDS: COPPER ALLOY.
 4.4 COIL TERMINALS: TEFLON WIRE UL1332 22AWG-WHITE.
 5. MAIN CONTACT M5 STUD, TORQUE: 1.7~2N·m.
 6. MOUNTING: M4 BOLT, RECOMMENDED TORQUE 1.8 ~ 2.3N·m.
 7. CONTACTOR PARAMETERS ARE SHOWN IN TABLE 1.

DIMENSIONS ARE SHOWN IN MILLIMETERS. DIMENSIONS AND TOLERANCES ARE DEFINED ACCORDING TO ANSIS/ASME Y14.5-1994.

PER CHNFPD20-008 PROCEDURE

- FIT/ FUNCTION CRITICAL CHARACTERISTICS
- <S> SAFETY/ COMPLIANCE CRITICAL CHARACTERISTICS SYMBOL
- CPK DENOTES CPK DIMENSIONS MINIMUM CPK VALUE
- (ST) DENOTES A CHARACTERISTIC THAT PROVIDES AN INDICATION OF PROCESS PERFORMANCE PROCEDURE FOR MEASUREMENT AND TRACKING TO BE DEFINED IN LITTELFUSE INSPECTION INSTRUCTIONS
- CP DENOTES CP DIMENSIONS. MINIMUM CP VALUE MUST BE WITHIN THE DIMENSIONAL LIMITATIONS SHOWN ON DRAWING AND INITIALLY LOCATED TO ALLOW FOR MAXIMUM TOOL LIFE

NAME	DATE
DRAWN JY. SHI	NOV./25/2021
CHECKED J. LI	NOV./15/2021

FORM NO. CVP-PE40-0005 REV B
 THIRD ANGLE PROJECTION

Littelfuse
 Expertise Applied | Answers Delivered

TITLE: DCNHR 40A POLAR CONTACTOR

SIZE: C DWG. NO. OUTLINE OL-DCNHR40PF, CHART 1 REV. A
 DO NOT SCALE DRAWING SCALE 2:1 SHEET 1 OF 1