

# MP8000 MOTOR PROTECTION RELAY

## Instruction Manual

REVISION 1-B-031324



All brand or product names appearing in this document are the trademark or registered trademark of their respective holders. No Littelfuse trademarks may be used without written permission. Littelfuse products appearing in this document may be covered by U.S. and Foreign patents.

Littelfuse, Inc. reserves all rights and benefits afforded under federal and international copyright and patent laws in its products, including without limitation software, firmware, and documentation.

The information in this document is provided for informational use only and is subject to change without notice. Littelfuse, Inc. has approved only the English language document.

This product is covered by the standard Littelfuse 5-year warranty. For warranty details, visit [www.littelfuse.com](http://www.littelfuse.com) or contact your customer service representative.

## TABLE OF CONTENTS

SECTION	PAGE	SECTION	PAGE
<b>1 Preface</b> .....	<b>3</b>	3.5.6 Current Connections .....	15
1.1 Manual Overview .....	3	3.5.7 Power Supply Connections (A1, A2).....	15
1.2 Safety Information .....	3	3.5.8 Inputs, PTC, ZSCT Connections .....	15
1.2.1 Dangers, Warnings, and Cautions.....	3	3.5.9 Input Connections (I.1).....	15
1.2.2 Safety Symbols.....	3	3.5.10 PTC Connections (T1, T2).....	16
1.2.3 Warnings, Cautions, and Notes .....	4	3.5.11 Zero-Sequence Current Transformer (ZSCT) (Z1, Z2) (for Ground Fault detection).....	16
1.2.4 Compliance Approvals.....	4	3.5.12 Connecting to a PC .....	16
1.3 General Information .....	4	3.5.13 Connecting to the Littelfuse MP8000 App .....	16
1.3.1 Typographic Conventions.....	4	<b>3.6 AC/DC Control Connection Diagrams</b> .....	<b>16</b>
1.3.2 Examples.....	4	3.6.1 Three-Phase Motor under 100 FLA with optional ZSCT and PTC connected .....	16
1.3.3 Product Labels .....	4	3.6.2 Three-Phase Motor over 100 FLA.....	17
1.3.4 Instructions for Cleaning and Decontamination.....	5	3.6.3 Single-Phase Applications.....	18
<b>2 Introduction and Specifications</b> .....	<b>5</b>	<b>4 Littelfuse MP8000 Smartphone and Tablet App</b> .....	<b>19</b>
2.1 Overview .....	5	4.1 Overview .....	19
2.2 Features.....	5	4.2 Installing the Android App .....	19
2.2.1 Standard Protection Features.....	5	4.3 Installing the iPhone/iPad App .....	19
2.2.2 Monitoring Features .....	5	4.4 Running the Littelfuse MP8000 App .....	19
2.2.3 Communications and Control .....	5	4.5 Advertising Page .....	19
2.2.4 Connectivity .....	5	4.6 Configuration Pages .....	20
2.2.5 Security.....	6	4.7 Configuration Basic Page (Protective Features).....	21
2.2.6 Power Supply.....	6	4.7.1 Low Voltage (LV) .....	21
2.3 Models, Options, and Accessories .....	6	4.7.2 High Voltage (HV).....	22
2.3.1 Models.....	6	4.7.3 Voltage Unbalance (VUB).....	22
2.3.2 Accessories.....	6	4.7.4 Overcurrent (OC) .....	22
2.4 Applications .....	6	4.7.5 Undercurrent (UC).....	22
2.5 Getting Started.....	7	4.7.6 Current Unbalance (CUB).....	22
2.5.1 Powering the Relay.....	7	4.7.7 Trip Class (TC).....	22
2.5.2 Establishing Communication .....	7	4.7.8 Restart Delay Zero (RD0).....	22
2.6 Specifications.....	7	4.7.9 Restart Delay One (RD1).....	23
2.6.1 Compliance .....	7	4.7.10 Restart Delay Two (RD2).....	23
2.6.2 General .....	7	4.7.11 Restart Delay Three (RD3).....	23
2.6.3 Type Tests .....	8	4.7.12 Undercurrent Restart Attempts (RU) .....	23
2.6.4 Current Transformers (CTs) .....	9	4.7.13 Other Faults Restart Attempts (RF).....	23
2.6.5 Relay Elements .....	9	4.7.14 Basic Settings Default Values .....	23
2.6.6 Metering .....	11	4.8 Configuration Advanced Page (Protective Features).....	23
<b>3 Installation</b> .....	<b>12</b>	4.8.1 Current Transformer Ratio (CT).....	23
3.1 Overview .....	12	4.8.2 Potential Transformer Ratio (PT) for Medium-Voltage Applications Greater Than 690 V ac .....	24
3.2 Phone Application .....	12	4.8.3 Undercurrent Trip Delay (UCTD) .....	24
3.3 Relay Placement.....	12	4.8.4 Linear OC Trip Delay (LINTD) .....	24
3.3.1 Physical Location .....	12	4.8.5 Ground Fault Trip Current (GFTC).....	24
3.4 Relay Features and Connections.....	12	4.8.6 Ground Fault Trip Delay (GFTD) .....	24
3.4.1 Relay Mounted on DIN Rail.....	13	4.8.7 Low Power Trip Limit (LKW) .....	24
3.4.2 Relay Mounted on Solid Surface or Panel .....	14	4.8.8 High Power Trip Limit (HKW).....	24
3.5 Relay Connections.....	14	4.8.9 High Power Trip Delay (HPTD) .....	25
3.5.1 Terminal Block Connections .....	14	4.8.10 Stall Percentage (STLP) .....	25
3.5.2 Wire Sizes.....	14	4.8.11 Stall Trip Delay (STTD).....	25
3.5.3 Voltage Connections (L1, L2, L3).....	14	4.8.12 Stall Inhibit Delay (STID) .....	25
3.5.4 Power Supply Connections (A1, A2).....	15		
3.5.5 Relay Contacts (1 Form C and 1 Form A) Connections .....	15		

<b>SECTION .....</b>	<b>PAGE</b>	<b>SECTION</b>	<b>PAGE</b>
4.8.13	Advanced Settings Default Values.....25	<b>5</b>	<b>PC Interface .....32</b>
4.8.14	Hardware Configuration Fields	<b>6</b>	<b>Troubleshooting .....33</b>
	Single-Phase Motor (SPM).....25	6.1	Overview .....33
4.8.15	Communication Settings	<b>7</b>	<b>Ground Fault Testing Procedure .....34</b>
	Ground Fault Motor Trip (GFMT).....26	<b>8</b>	<b>Appendix .....35</b>
4.9	Configuration Device Info Page .....27	<b>9</b>	<b>Appendix A .....41</b>
4.9.1	Controller Revision .....27	9.1	Summary of Operations .....41
4.9.2	Bluetooth Revision.....27	9.2	Use Case Examples.....41
4.9.3	Mac Address.....27		
4.9.4	Change Password .....27		
4.9.5	Reset Password .....27		
4.9.6	Change Device Name .....28		
4.9.7	Change Static IP .....28		
4.9.8	Sync Clock.....28		
4.9.9	Reset Motor Service Time .....28		
4.9.10	Reset Motor Start Count .....28		
4.9.11	Reset kVARhr/kWhr .....28		
4.10	Real-Time Page (Measurements & Monitoring).....28		
4.10.1	Device ID.....28		
4.10.2	Reset Relay.....28		
4.10.3	System Status.....28		
4.10.4	Active Timer.....28		
4.10.5	Line-to-Line Voltage.....28		
4.10.6	Voltage Unbalance.....28		
4.10.7	Line Current .....28		
4.10.8	Current Unbalance.....28		
4.10.9	Power.....29		
4.10.10	Measured Power .....29		
4.10.11	Power Factor .....29		
4.10.12	Ground Fault Current.....29		
4.10.13	Motor Run Time in Hours .....29		
4.10.14	Motor Service Time.....29		
4.10.15	Start Count .....29		
4.10.16	Thermal Capacity .....29		
4.10.17	Motor Relay State.....29		
4.10.18	AUX Relay State.....29		
4.11	Fault Page .....29		
4.12	Time Settings .....30		
4.13	Setting the IP Address .....30		
4.13.1	Device ID.....30		
4.13.2	Point to Point IP Address Assignment (no DHCP).....30		
4.13.3	Changing IPv4 Settings.....30		

## 1. PREFACE

### 1.1 Manual Overview

The MP8000 Motor Management Relay Instruction Manual describes common aspects of motor relay application and use. It includes the necessary information to install, set, test, and operate the relay.

An overview of each manual section and topics follows:

#### 1. PREFACE

Describes the manual organization and conventions used to present information.

#### 2. INTRODUCTION AND SPECIFICATIONS

Describes the basic features and functions of the MP8000; lists the relay specifications and associated models.

#### 3. INSTALLATION

Describes how to mount and wire the MP8000; illustrates wiring connections for various applications.

#### 4. SMARTPHONE/TABLET APPLICATION

Describes the features, installation methods, and types of help available with the Littelfuse MP8000 App, including setting the relay, meter and monitoring, control, and fault retrieving.

#### 5. PC INTERFACE

Describes the features, installation methods, and types of help available with the Littelfuse MP8000 Software, including setting the relay, meter and monitoring, control, and events retrieving.

#### 6. TROUBLESHOOTING

Describes common causes for various trip/fault conditions.

#### 7. GROUND FAULT TESTING

### 1.2 Safety Information

#### 1.2.1 Dangers, Warnings, and Cautions

This manual uses three kinds of hazard statements, defined as follows:



Indicates an imminently hazardous situation that, if not avoided, will result in death or serious injury.



Indicates a potentially hazardous situation that, if not avoided, could result in death or serious injury.



Indicates a potentially hazardous situation that, if not avoided, may result in minor or moderate injury or equipment damage.

#### 1.2.2 Safety Symbols

The following symbols are often marked on Littelfuse products.

	<b>CAUTION</b> Refer to accompanying documents.
	Earth (ground)
	Protective earth (ground)
	Direct current
	Alternating current
	Both direct and alternating current
	Instruction manual

### 1.2.3 Warnings, Cautions, and Notes

#### **WARNING**

Use of this equipment in a manner other than specified in this manual can impair operator safety safeguards provided by this equipment.

#### **WARNING**

Installation should be done by qualified personnel following all national, state and local electrical codes. Have only qualified personnel service this equipment. If you are not qualified to service this equipment, you can injure yourself or others, or cause equipment damage.

#### **CAUTION**

Equipment components are sensitive to electrostatic discharge (ESD). Undetectable permanent damage can result if you do not use proper ESD procedures. Ground yourself, your work surface, and this equipment before installing this equipment. If your facility is not equipped to work with these components, contact Littelfuse about returning this device and related Littelfuse equipment for service.

NOTE: This device is shipped with default passwords. Default passwords should be changed to private passwords at installation. Failure to change each default password to a private password may allow unauthorized access. Littelfuse shall not be responsible for any damage resulting from unauthorized access.

### 1.2.4 Compliance Approvals



## 1.3 General Information

### 1.3.1 Typographic Conventions

You can communicate with the MP8000 in three ways.

- Use the Littelfuse MP8000 app, iPhone/iPad or Android. The MP8000 uses Bluetooth 4.0 (Bluetooth Low Energy - BLE). The smartphone or tablet must have BLE to connect to the MP8000.
- Use the Ethernet port connected to a PC (via network) with Littelfuse MP8000 Software installed.
- Use the Ethernet port connected to a network and create a Modbus TCP or Ethernet/IP program using the MP8000 memory map.

### 1.3.2 Examples

This instruction manual uses several example illustrations and instructions to explain how to effectively operate the MP8000. These examples are for demonstration purposes only; the firmware identification information or settings values included in these examples may not necessarily match those in the current version of your MP8000.

### 1.3.3 Product Labels

The MP8000 label and MP8010\* label is shown below. The label is located on the right side panel of the product.

#### Product Compliance Label for the MP8000

**MP8000** 

**Advanced Motor Protection Overload Relay**

---

**Control Power Input: 90-265VAC**

**Voltage Input (L-to-L): 90-690VAC 50/60Hz 1Ø/3Ø**

**Input Current: 0.5-100A Direct; 100-1000A\***

**Contact Rating: 5A @ 240VAC, B300**

**Pair Code Password: 966352**

**Setpoint Default Password: admin**

**MAC Address: 00:21:6F:00:41:F5**



\*With External CT's Date Code: 2018/06

Contains FCC ID: TFB-1002  
Contains IC: 5969A-1002

Patented Product



**Product Compliance Label for the MP8010**

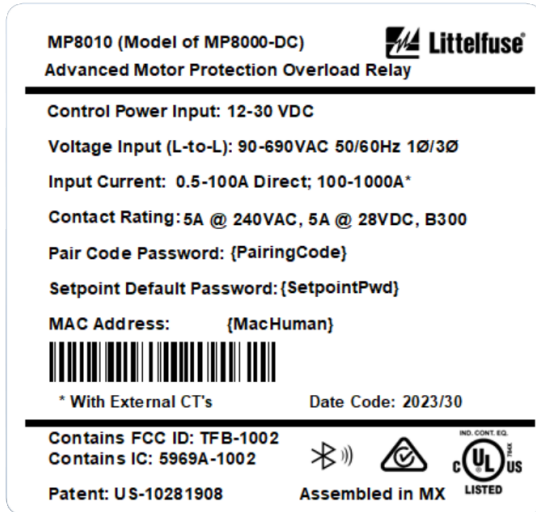

**1.3.4 Instructions for Cleaning and Decontamination**

Use a mild soap or detergent solution and a damp cloth to carefully clean the MP8000 chassis when necessary. Avoid using abrasive materials, polishing compounds, and harsh chemical solvents (such as xylene or acetone) on any surface of the relay.

**2. INTRODUCTION AND SPECIFICATIONS**

**2.1 Overview**

The MP8000 Motor Protection Relay is designed to protect three-phase or single-phase motors. The basic relay provides locked rotor, overload, over-temperature, and unbalance protection. Voltage-based protection elements are standard. Additionally, the relay includes inverse time-over current elements suitable for overload protection. All relay models provide monitoring functions.

The relay operates as a fail-safe device. This means when the voltage is within the programmed limits, the relay will energize—the NO contact will close. When the unit loses power or senses a fault condition, the relay will de-energize and contacts will return to their original state. Once the unit has been installed and programmed, the unit is ready to operate. Once acceptable voltage is applied and the RD0 timer expires, the relay will energize—the NO contact will close.

This manual contains the information needed to install, set, test, operate, and maintain any MP8000. You need not review the entire manual to perform specific tasks.

**2.2 Features**

**2.2.1 Standard Protection Features**

- Overload (Overpower) (49)
- Underload (Underpower) (37P)
- Undercurrent (Load Loss) (37)
- Current Unbalance/Phase Loss (46)
- Overcurrent (Load Jam) (51)
- Ground Fault—Zero-Sequence (50Ns)
- Manual Motor Reset input
- Phase Time-Overcurrent (51)
- Phase Reversal (47), voltage based
- Voltage Unbalance (47)
- Motor Starting/Running
  - Start Motor Run-Timer
  - Thermal Capacity Utilization (TCU)
- Contactor Failure Protection
- Positive Temperature Coefficient (PTC) Over-Temperature Switching Thermistor (49)
- Undervoltage (27)
- Overvoltage (59)
- Power Elements (32)

**2.2.2 Monitoring Features**

- Event Summaries that contain relay ID, date and time, trip cause, and current/voltage magnitudes
- Sequential Multiple Events Recorder (SER)
- Power Factor
- Running times
- Number of starts
- A complete suite of accurate metering functions
- Thermal Capacity Used

**2.2.3 Communications and Control**

- Ethernet Modbus TCP, Ethernet FTP, Ethernet/IP
- Bluetooth 4.0 (Bluetooth Low Energy - BLE)

**2.2.4 Connectivity**

- Voltage: direct connection (as high as 690 VAC, line-to-line); three-wire delta, open-delta or single-phase connected Potential Transformers
- Current: Built-in pass-through current transformers for 0.5-100A phase current measurements
- External current transformer inputs for >100A phase current measurements
- Zero-Sequence Ground Fault CT input
- Positive Temperature Coefficient Input (PTC)
- Digital Outputs: one Form-A output contacts, one Form-C output contact
- Digital Inputs: Externally wetted to 110/240 VAC

**2.2.5 Security**

- Pairing and Setpoint change pass codes on side labels, unique to each MP8000

**2.2.6 Power Supply**

- Wide input range 85-264VAC, 12 - 30 VDC (MP8010)

**2.3 Models, Options, and Accessories**

**2.3.1 Models**

Complete ordering information is not provided in this instruction manual. See the latest MP8000 and associated models Option Table at [www.littelfuse.com](http://www.littelfuse.com).

**2.3.2 Accessories**

Contact your Technical Service Center or the Littelfuse factory for additional detail and ordering information for the following accessories/options:

- Zero-Sequence CTs
- ZSCT5-31, 31mm (1.22")
- ZSCT5-88, 88mm (3.46")

**2.4 Applications**

Section 3: Installation includes connection diagrams for various applications. The following is a list of possible application scenarios:

- With or without external current and/or voltage transformer
- Full voltage non-reversing (FVNR) starter (across the line)
- Forward/reverse starter – Accomplished by placing the MP8000 “above” the forward and reverse contactors.

Figure 2.1 shows across-the-line starting AC connections with optional ZSCT and PTC. Refer to Section 3: Installation for additional applications and the related connection diagrams.

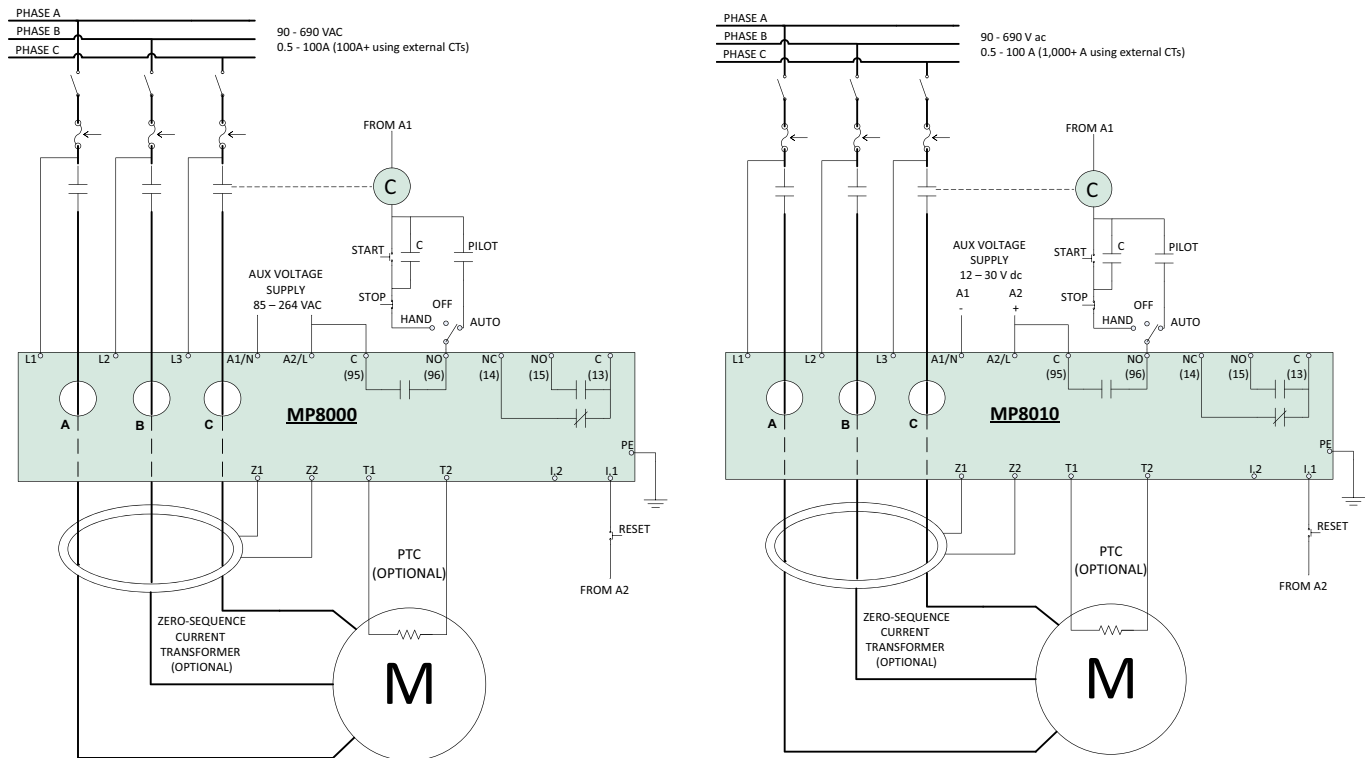

**Figure 2.1 AC Connections - Across-the-Line Starting**



## 2.5 Getting Started

Understanding basic relay operation principles and methods will help you use the MP8000 effectively. This section presents the fundamental knowledge you need to operate the MP8000, organized by task. These tasks help you become familiar with the relay and include the following:

- Powering the relay
- Establishing communication
- Inputting configuration settings
- Checking relay status

Perform these tasks to gain a fundamental understanding of relay operation.

### 2.5.1 Powering the Relay

All voltage hold-off conditions (Phase Reversal, LV, HV, VUB) must be satisfied before the 'OK' condition can be met to allow the motor to activate. After the motor is active the voltage hold-off conditions are still measured but they will NOT cause a fault condition to stop the motor.

Power the MP8000 with 85-264 V ac or 12-30 V dc (MP8010).

- Connect the earth ground lead; see figure 2.1 for Power Supply Connections.
- Once connected to power, the relay does an internal self-check, flashing all LEDs. After the self-check, either the green STATUS LED, or the red ERROR LED will be illuminated. If the green STATUS LED is on, the relay status is "ok"; and the control relay will be closed. If any condition is present that will not allow the control relay to close, or the relay is tripped (and/or restarting), the red ERROR LED will be illuminated and the green STATUS LED will be off.

### 2.5.2 Establishing Communication

The standard MP8000 has a Bluetooth Low Energy (BLE) interface via Littelfuse MP8000 app and an Ethernet port via Littelfuse MP8000 Software. When the MP8000 has successfully connected to a Bluetooth Low Energy enabled device running the MP8000 app, the blue LED is illuminated.

See Section 4: Littelfuse MP8000 Smartphone and Tablet App for more information on app installation and operation.

See Section 5: PC Interface for more information on MP8000 Software installation and operation.

## 2.6 Specifications

NOTE: Motors/loads with FLA > 100 amps must use external CTs. You must use CTs that have a rated secondary current of 5 amps (examples 50:5, 100:5, 200:5, etc.).

### 2.6.1 Compliance

CE Mark:	EMC Directive Low-Voltage Directive
IEC:	IEC 60947-1 Edition 5.2 (UL 60947), IEC 60947-8-1, EC 60947-4-1
UL, cUL:	UL-1053, C.22.2 No. 14
RCM:	AS/NZS 4417.1 AS/NZS 4417.2

### 2.6.2 General

#### AC Current Inputs—Phase

Full Load Amperage (FLA):	0.5–100.0 A (> 100 A with external CTs)
Rated Frequency:	50/60 Hz
Burden (Per Phase):	0.0025 VA @ 30 A

#### Zero-Sequence CT Current (IN)

Zero-Sequence CT Ratio:	100:1
Input Rated Current Range:	0.010–50.0 mA
Input Rated Continuous Thermal Current:	150 mA
One Second Thermal Current:	1.5 A
Saturation Current:	5-50 mA
Burden:	0.09 VA at 50 mA

#### AC Voltage Inputs (Line-to-Line)

Rated Operating Voltage (Ue):	90–690 VAC
Rated Continuous Voltage:	800 VAC
Rated Frequency:	45/65 Hz
Burden:	< 0.72 VA @ 690 VAC

#### Power Supply

Rated Supply Voltage:	85-264 VAC, 12 - 30 VDC (MP8010)
Power Consumption:	< 5 W
Interruptions:	20 ms minimum

#### Output Contacts

General	
Mechanical Durability:	100,000 no load operations
Pickup/Dropout Time:	< 10 ms (coil energization to contact closure)

#### AC Output Ratings for relays;

CONTROL (Form A), ALARM (Form C)	
Contact Rating Designation:	B300 (B = 5 A, 300 = rated insulation voltage)

Maximum Operational Voltage:	250 VAC
------------------------------	---------

Maximum Operational Current:	5 A
Rated Frequency:	50/60 ±5 Hz

Electrical Durability Make VA Rating:	3600 VA
---------------------------------------	---------

Electrical Durability Break VA Rating:	360 VA
--	--------



**RFI and Interference Tests**

Electrostatic Discharge (ESD): IEC 61000-4-2, Level 3, 6kV contact, 8kV air

Radio Frequency Immunity (RFI), Conducted : IEC 61000-4-6, Level 3 10V/m

Radio Frequency Immunity (RFI), Radiated: IEC 61000-4-3, Level 3 10V/m

Fast Transient Burst: IEC 61000-4-4, Level 3, 3.5kV input power

Surge: IEC 61000-4-5, Level 3, 2kV line-to-line; Level 4, 4kV line-to-ground

FCC Rating: Part 15.107 for emissions, Part 15.247 for intentional radiators

**Fault Events Recorder**

Number of faults stored: 1,000 (most recent faults)

Time-Stamp Resolution: 1 second

Time-Stamp Accuracy (With Respect to Time Source): ±1 second

**2.6.4 Internal Current Transformers (CTs)**

Our Full-Load Current (FLA) Limits: 0.5–100.0 A

NOTE: Motors/loads with FLA > 100 amps must use external CTs. You must use CTs that have a rated secondary current of 5 amps (examples 50:5, 100:5, 200:5, etc.).

**2.6.5 Relay Elements**

See section Littelfuse MP8000 Smartphone and Tablet App > Configuration Page for details on programming relay behavior. The numbers in parenthesis in the following specifications are ANSI device numbers.

**Phase-to-Phase Under Voltage (27)**

NOTE: Motors/loads operating at voltages higher than 690 V<sub>RMS</sub> must use external PTs.

Parameter Name: Low Voltage (LV)

Enable/Disable: No disable available

Setting Range: 90 V<sub>RMS</sub> minimum

Accuracy: ±1% of setting ±2 V<sub>RMS</sub>

**High Power (49)**

Parameter Name: High Kilo-Watt (HKW)

Enable/Disable: Default is disabled

Setting Range: Not limited

Accuracy: ±5% of setting ±5 Watts

**Under Power (37P)**

Parameter Name: Low Kilo-Watts (LKW)

Enable/Disable: Default is disabled

Setting Range: Not limited

Accuracy: ±5% of setting ±5 Watts

**Undercurrent (Load Loss) (37)**

Parameter Name: Under Current (UC)

Enable/Disable: Default Undercurrent value is 5

Setting Range: Not limited; Suggest 0.75–0.95 • FLA

Accuracy: ±2% of setting ±0.01 A<sub>RMS</sub>

Pickup/Dropout Time: 1 second + programmable delays

**Current Unbalance and Phase Loss (60P)**

Parameter Name: Current Unbalance (CUB)

Enable/Disable: Default is enabled

Setting Range: Not limited; Default 7%; Suggest 5–45%

Accuracy: ±5% of setting

Maximum Pickup/ Dropout Time: See Table 2.2. Additional delays for motor startup may apply

**Table 2.2 CUB Trip Time, CUTD=30**

MEASURED VALUE OF CURRENT UNBALANCE	TRIP TIME
CUB setting	30 seconds
CUB setting + 1%	15 seconds
CUB setting + 2%	10 seconds
CUB setting + 3%	8 seconds
CUB setting + 4%	6 seconds
CUB setting + 5%	5 seconds
CUB setting + 6%	4 seconds
CUB setting + 10%	3 seconds
CUB setting + 15% or more	2 seconds

Example:

CUB setting = 5%  
If measured value of current unbalance is 6% the MP8000 will trip in 15 seconds

**Voltage Unbalance (47)**

Parameter Name: Voltage Unbalance (VUB)

Enable/Disable: Default is enabled

Setting Range: Not limited; Default 5%; Suggest 2%-25%

Accuracy: ±1% of setting ±2 V<sub>RMS</sub>

**Phase Reversal (47)**

Rotation Direction: Programmable; Default ABC

NOTE: Voltage Unbalance and Phase Reversal conditions are detected prior to motor startup. After startup, these conditions are not monitored.

**Incomplete Sequence (Load Jam/Stall) (51R)**

Parameter Name: Stall Percentage Current (STLP)  
 Enable/Disable: Default is disabled  
 Setting Range: Not limited; Suggest is 400% of OC  
 Accuracy:  $\pm 2\%$  of setting  
 Maximum Pickup/  
 Dropout Time: Programmable  
 (Stall Time Delay seconds)

**PTC Over-Temperature (49)**

Type of Control Unit: IEC 60947-8, mark A  
 Max. Number  
 of Thermistors: Must adhere to the limits below  
 Over Temp Trip Resistance:  $\geq 1650 \pm 80$  ohms  
 Reset Range:  $\geq 25$  ohms and  $\leq 1500$  ohms  
 Short circuit Detection  
 Resistance:  $\leq 20 \pm 5$  ohms  
 Maximum Cold Resistance: 1500 ohms

**Ground Fault - Residual Method (Zero-Sequence)(50N)**  
 Best protection is with a resistively grounded system

Parameter Name: Ground Fault Trip Current (GFTC)  
 Ground Fault Trip Delay (GFTD)  
 GFTC Setting Range: GFTC = 0 is OFF (disabled);  
 Default is disabled.  
 Suggested Range is 0.20–4.5 A  
 Accuracy:  $\pm 2\%$  of setting  $\pm 0.01 A_{RMS}$   
 Time Delay: Class I operation 0.5 – 1.0 seconds  
 Class II operation 1.1 – 5.0 seconds  
 Values above 5 seconds are non-standard  
 Timing Accuracy:  $\pm 250$  ms

**Overcurrent (51)**

Parameter Name: Linear Overcurrent Trip Delay (LINTD)  
 Enable/Disable: Default is disabled  
 Setting Range: Not limited; Default is 0 Seconds  
 Accuracy:  $\pm 2\%$  of setting  $\pm 0.1$  second

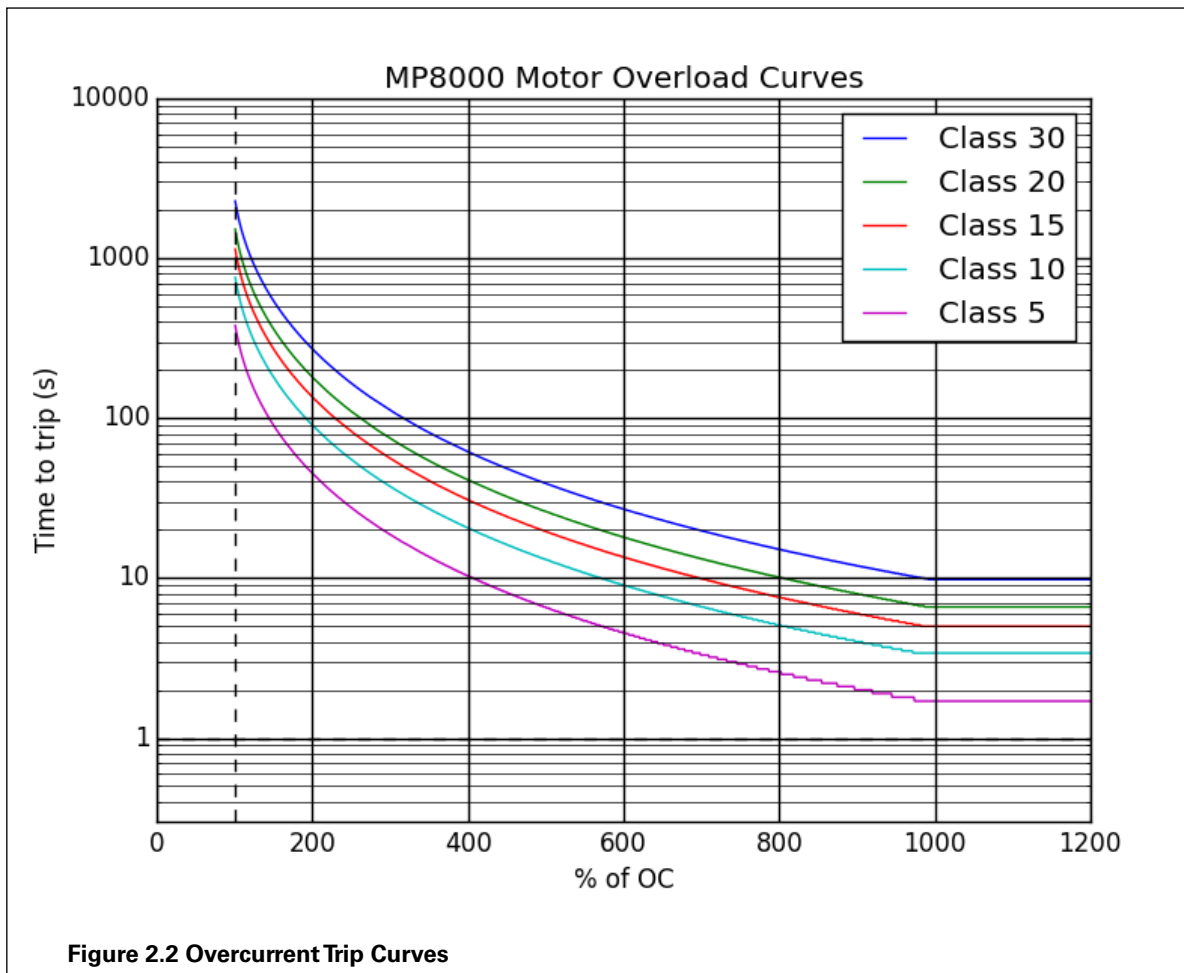

**Inverse-Time Overcurrent (51)**

Parameter Name:	Trip Class (TC)
Enable/Disable:	Default is enabled
Setting Range:	Not limited; common values 5, 10, 15, 20, 30
Accuracy:	See Figure 2.2; $\pm 2\%$ of setting $\pm 0.1$ second

**Phase-to-Phase Overvoltage (59P)**

NOTE: Motors/loads operating at voltages higher than 690 V<sub>RMS</sub> must use external PTs.

Parameter Name:	High Voltage (HV)
Enable/Disable:	No Disable available
Setting Range:	Not limited
Accuracy:	$\pm 1\%$ of setting $\pm 2$ V
<b>Timers (See section 4.7 for details on RD0-RD3)</b>	
Setting Range:	Various
Accuracy:	$\pm 0.5\%$ of setting $\pm 1$ second

**2.6.6 Metering**

Accuracies are specified at 20°C, 50 or 60 Hz nominal frequency, AC currents within 0.5 – 100 A<sub>RMS</sub>, and ac voltages within 90–690 V<sub>RMS</sub> unless otherwise noted.

Line-to-Line Voltages:	$\pm 1\%$ of reading $\pm 0.5$ V <sub>RMS</sub>
Voltage Unbalance (%):	$\pm 1\%$ of reading
Phase Currents:	$\pm 2\%$ of reading $\pm 0.05$ A <sub>RMS</sub>
Current Unbalance (%):	$\pm 2\%$ of reading
Real Power (kW):	$\pm 5\%$ of reading for $0.10 < \text{pf} < 1.00$
Power Factor:	$\pm 3\%$ of reading
Thermal Capacity Used:	$\pm 5\%$ of reading
Reactive Power (kVAR)	$\pm 5\%$ of reading
kWhr	$\pm 5\%$ of reading (3-phase applications) $\pm 7\%$ of reading (single-phase applications)
kVARhr	$\pm 5\%$ of reading (3-phase applications) $\pm 7\%$ of reading (single-phase applications)

### 3. INSTALLATION

#### 3.1 Overview

The first steps in applying the MP8000 Motor Protection Relay are installing and connecting the relay. This section describes common installation features and requirements. To install and connect the relay safely and effectively, you must be familiar with relay configuration features and options. You should carefully plan relay placement, cable connections, and relay communication.

This section contains drawings of typical AC and DC connections to the MP8000. Use these drawings as a starting point for planning your particular relay application.

#### 3.2 Smartphone/Tablet Application

The installation details for the Littelfuse MP8000 app are presented in Section 4. There are two options:

- Android (supports versions 11.0 and higher)
- iOS (supports versions 13.0 or newer)

#### 3.3 Relay Placement

Proper placement of the MP8000 helps to ensure years of trouble-free motor management. Use the following guidelines for proper physical installation of the MP8000.

##### 3.3.1 Physical Location

Mount the MP8000 in a sheltered indoor environment (a motor control center drawer or bucket, a building, or an enclosed cabinet) that does not exceed the temperature, humidity, and IP ratings for the relay.

See environmental specifications in section 2.6.

#### 3.4 Relay Features and Connections

Figure 3.1 shows the relay features and connections to cover all the ordering options. The wiring terminal blocks are labeled as shown on the relay.

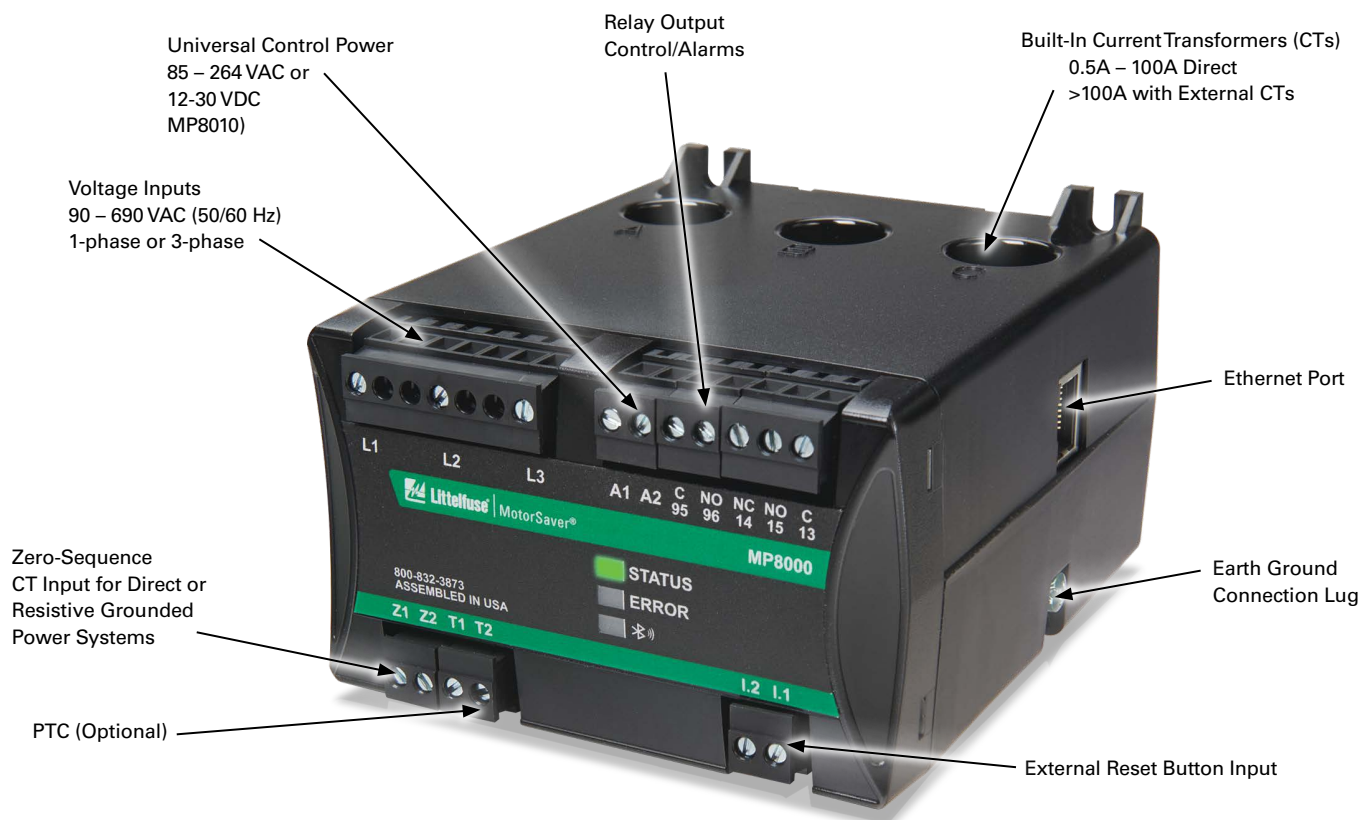
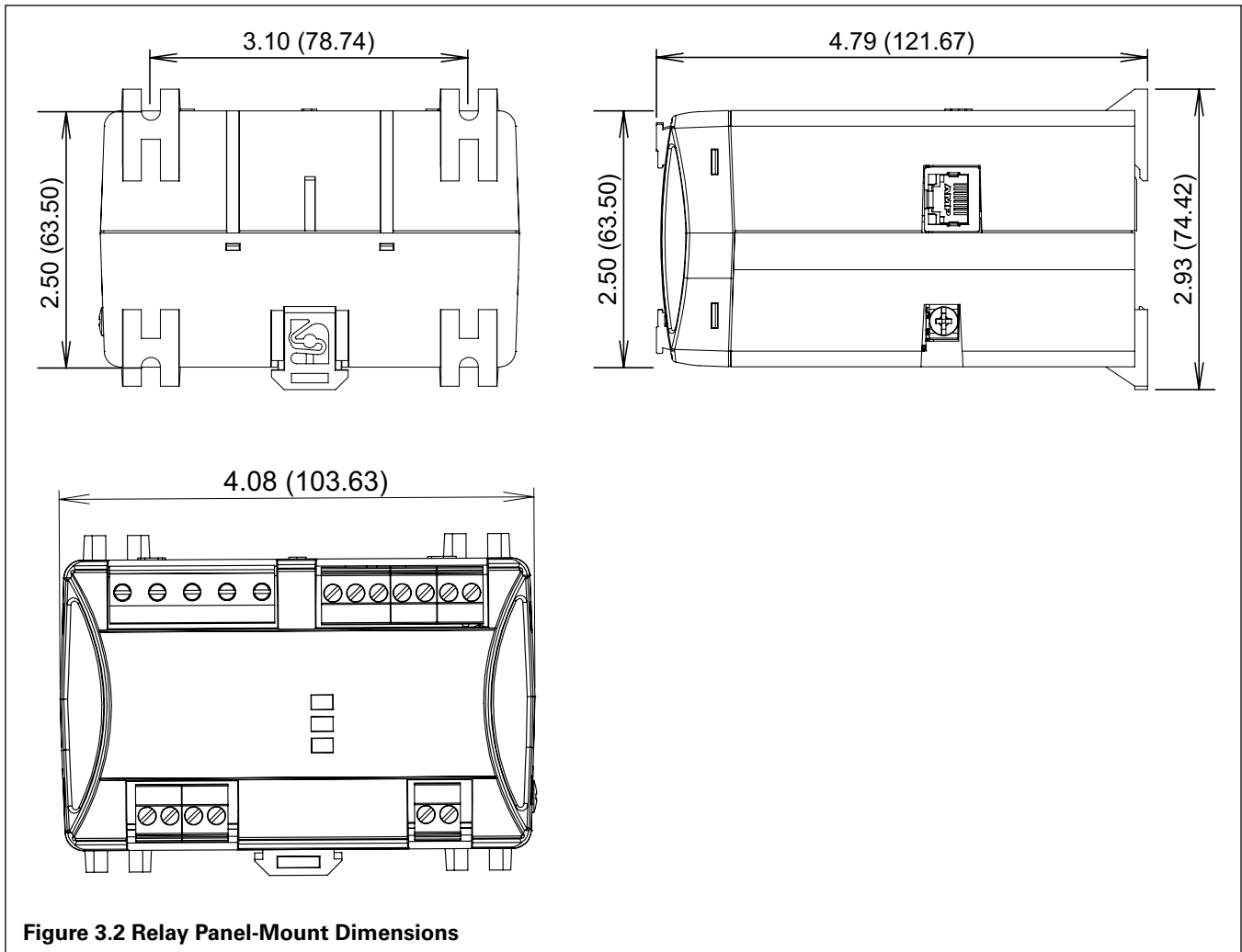

Figure 3.1 Relay Features and Connections

Figure 3.2 shows the relay drawings with dimensions to cover all the ordering options. The wiring terminal blocks are labeled on the relay.



### 3.4.1 Relay Mounted on DIN Rail

The MP8000 can be mounted on a 35 mm (1.38 in) DIN rail. Install the relay on the DIN rail as shown in Figure 3.3 and push the relay towards the rail until the bottom clip latches and the relay clicks into place.

To remove the relay, use a small flat-bladed screw driver or other similar tool. Insert the tool into the latching clip and pry it towards the relay. The clip slides away from the DIN rail, releasing it.

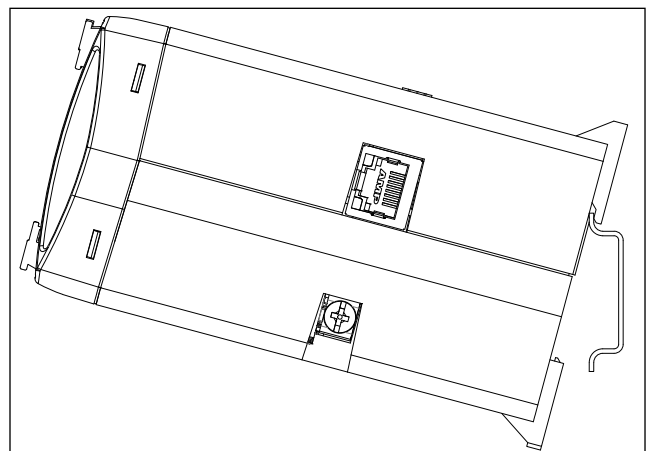

**Figure 3.3 Relay Mounting on DIN Rail**

### 3.4.2 Relay Mounted on Solid Surface or Panel

The drawing in Figure 3.4 shows how the relay is mounted on a panel or a flat surface. The screws are #8 or 4 mm and the tightening torque specification is 9.0 in-lbs (1.0 Nm). Use the panel drilling template for the location of the screw holes.

## 3.5 Relay Connections

This section will provide a guide to complete connections to the relay for various functions.

### 3.5.1 Terminal Block Connections

The connection terminal blocks are labeled on the relay as shown in Figure 3.5

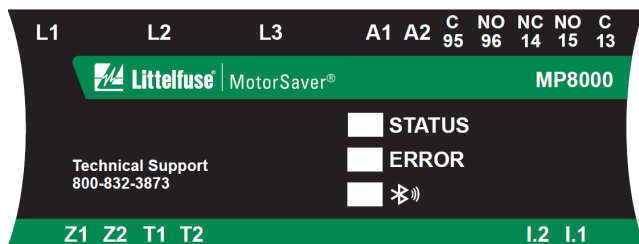
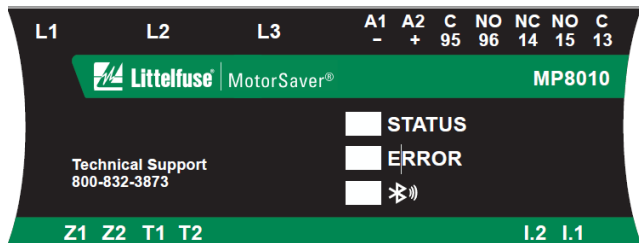

Figure 3.5 Relay Terminal Block connections labeling



The terminal blocks are depluggable and can be removed by gently prying them with a small, flat screwdriver. The torque requirements for the terminal blocks are:

- Compression Plug (Black, 5.08mm spacing)  
Tightening Torque
  - Maximum: 0.62 Nm (5.5 in-lb)
- Earth Ground Lug Tightening Torque
  - Maximum: 0.89 Nm (7.9 in-lb)

### 3.5.2 Wire Sizes

Acceptable wire sizes for earth grounding and terminal blocks are shown in Table 3.1. Conductors used for carrying the motor load should be determined by NEC code. Strip the wire insulation for terminal blocks to 8 mm (0.31 in) before installation.

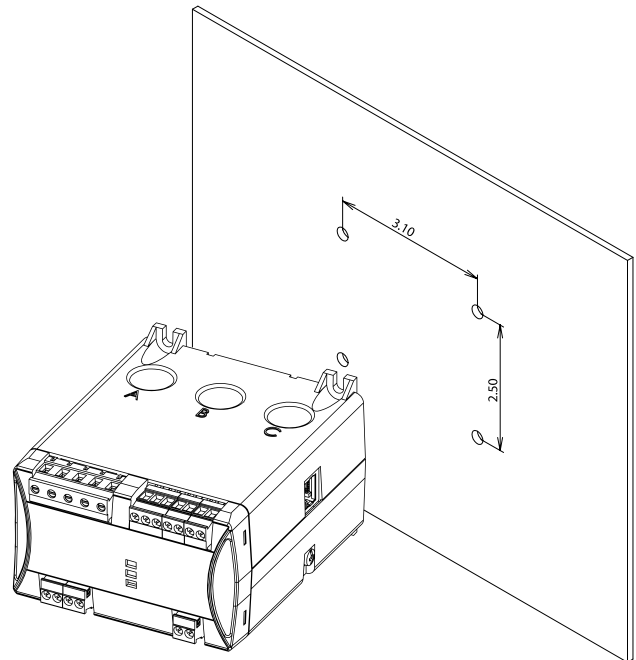

Figure 3.4 Relay Mounting on Solid Surface or Panel

Table 3.1 Wire Connection Selection Guide

CONNECTION TYPE	MIN. WIRE SIZE	MAX. WIRE SIZE
Earth Grounding Connection	18 AWG (0.8 mm <sup>2</sup> )	14 AWG (2.1 mm <sup>2</sup> )
Terminal Blocks	18 AWG (0.8 mm <sup>2</sup> )	12 AWG (3.3 mm <sup>2</sup> )

### 3.5.3 Voltage Connections (L1, L2, L3)

Terminals L1, L2, and L3 are used to measure the input voltages and detect phase sequence/rotation. The acceptable phase rotation is programmable. See Section 4.8.14, Phase ACB Rotation.

Table 3.2 AC Voltage Inputs (as High as 690 VAC Line-to-Line)

TERMINAL LABEL	DESCRIPTION
L1	Line 1 (Phase A) voltage input
L2	Line 2 (Phase B) voltage input
L3	Line 3 (Phase C) voltage input



### 3.5.4 Power Supply Connections (A1, A2)

The POWER terminals on the relay A1 and A2 must connect to 85-264 V ac or 12-30 V dc (MP8010) power source (see Power Supply in section 2.6.2 for complete power input specifications). The POWER terminals are isolated from chassis ground.



### 3.5.5 Relay Contacts (1 Form C and 1 Form A) Connections

The MP8000 comes with one Form C (AUXILIARY) and one Form A (CONTROL) relay contacts. They are rated for continuous carry current of 5A at 70 degrees C. See Table 3.3 below.

- The Motor Contactor relay coil is energized if all conditions for safe motor operation are met.
- When the MP8000 generates a trip signal, the relay coil is de-energized.
- The relay coil is also de-energized if the MP8000 power supply voltage is removed or if the MP8000 fails.

The MP8000 Auxiliary relay may be energized for alarms or other control.

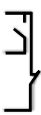
**Table 3.3 Two (2) Relay Contact Connections**

TERMINAL LABEL	DESCRIPTION
 C (13) NO (15) NC (14)	Auxiliary relay (Form C) May be energized for alarms or other control functions.
 C (95) NO (96)	Motor Contactor Control (Form A) If no trip or hold-off condition is present these contacts will close.

### 3.5.6 Current Connections

IMPORTANT, THE WIRING REQUIREMENTS LISTED BELOW ARE REQUIRED FOR ACCURATE POWER FACTOR AND POWER MONITORING:

1. The current carrying conductor connected to the L1 voltage must pass through the Phase A hole.
2. The current carrying conductor connected to the L2 voltage must pass through the Phase B hole.
3. The current carrying conductor connected to the L3 voltage must pass through the Phase C hole.

The MP8000 has markings on the top to indicate the direction of the current flow. The SOURCE side (A,B, C) is the side from which the current from the power system flows through the relay.

The MP8000 directly supports currents up to Full-Load Amps (FLA) of 100 A. Refer to Figure 2.1 for an application example. The CT ratio setting is set equal to 1 for the direct current inputs. For higher FLA currents, the relay supports external CT connections. Figure 3.6 shows an application example with external CTs. This application requires a CT ratio equal to or greater than 10, and a CT setting equal to the primary of the CT. For the additional information, please see Section 4.8. All external CTs require the secondary to be 5 Amps (150:5, 400:5, etc.).

### LOW CURRENT APPLICATIONS

If improved accuracy of the current readings is desired for applications where the FLA is less than 2 amps the current wires may be passed through each phase current 'window' multiple times (up to 10 times max). In this configuration the CT number reflects the number of passes through the window the wires have been 'looped'. Example: 5 passes of each conductor through each CT window will require a CT ratio setting of 5. See Table 4.3 for examples.

### 3.5.7 Ground Terminal Connection

Connect the ground terminal of the relay to the chassis or cabinet ground. See Figure 2.1. Ground connection is required to meet all EMC requirements.

### 3.5.8 Inputs, PTC, ZSCT Connections (optional)

**Table 3.4 Input, PTC Input, ZSCT input**

TERMINAL LABEL	DESCRIPTION
I.1 (Reset)	Normally Open Reset Button Input (relay reset button - momentary)
T2 (PTC)	PTC Thermistor input terminals
T1 (PTC)	
Z2 (ZSCT)	Zero-Sequence Ground Fault Current Transformer input terminals
Z1 (ZSCT)	

### 3.5.9 Input Connections (I.1) (optional)

Connect Terminal I.1 as a Reset (relay reset) input. When the Normally Open Reset button is pressed, A2 terminal voltage should be applied to I.1 (Reset) input. Figure 2.1 shows the connection diagram for an MP8000 Reset (relay reset) button.

### 3.5.10 PTC Connections (T1, T2) (optional)

Connect the positive temperature coefficient (PTC) thermistor to Terminals T2 (PTC) and T1 (PTC). Table 3.5 shows the maximum cable lengths for the PTC connections.

**Table 3.5 PTC Cable Requirements**

WIRE SIZE, TWISTED PAIR AWG NO.	MAXIMUM LENGTH (METERS)	
	SHIELDED CABLE	UNSHIELDED CABLE
20	200	100
18	300	100
17	400	100
16	600	100
14	1000	100

### 3.5.11 Zero-Sequence Current Transformer (ZSCT) (Z1, Z2) (for Ground Fault detection) (optional)

The ZSCT input terminals Z1, Z2 allow you to connect a zero-sequence current transformer for measuring the ground fault current directly from the three-phase motor conductors passing through it. This method is best suited for use on high-impedance grounded power systems. It is also preferred when a sensitive measurement is required. The maximum length of the twisted pair of wires from the ZSCT to the MP8000 relay terminals Z1, Z2 should be limited to 5 feet or less and currently limited to 100A zero-sequence CTs.

Refer to Figure 2.1 for an example of ZSCT application connections. Refer to Basic Settings in Section 4: Littelfuse MP8000 Smartphone and Tablet Section 4.8.5 for details on ZSCT application and settings considerations.

\*Applicable Littelfuse part numbers:

- ZSCT5-31, 31mm (1.22")
- ZSCT5-88, 88mm (3.46")

### 3.5.12 Connecting to a PC (optional)

The PC Ethernet port is connected to the MP8000 Ethernet port using a Standard Ethernet (RJ-45) cable.

See Section 5: PC Interface for more information on MP8000 Software installation and operation.

### 3.5.13 Connecting to the Littelfuse MP8000 App

Connection to the Littelfuse MP8000 App is performed over a Bluetooth Low Energy (BLE) wireless interface. The Littelfuse MP8000 App is available for iPhone, iPad, and Android smartphones and tablets.

See Section 4: Littelfuse MP8000 Smartphone and Tablet App for more information on app installation and operation.

## 3.6 Motor Configuration Connection Diagrams

The following section describes various types of applications for the MP8000 and provides the connection for each one. If the 3-phase voltage inputs are not connected properly, the MP8000 will not allow motor operation. The voltage inputs must be aligned with the current inputs (pass through window/hole). L1 input must connect to Line 1 (Phase A) and the Phase A motor power wire must pass through the Phase A "window" (hole). It must pass through the window with the power source (side with the letter "A") and load (motor) being on the correct side of the MP8000.

### 3.6.1 Three-Phase Motor under 100 FLA with optional ZSCT and PTC connected

See Figure 2.1. Refer to Sections 4.7 and 4.8 for appropriate settings.

**3.6.2 Three-Phase Motor over 100 FLA**

Refer to Figure 2.1 for all voltage and control wiring. Refer to Figure 3.6 for external current transformer wiring. Refer to Sections 4.7 and 4.8 for all settings.

NOTE: CT ratio must be changed to accommodate the CT ratio used. Example: a CT ratio of 200:5, program 200 for CT.

NOTE: For accurate power measurements, the CT must be wired as shown in Figure 3.6 for both direction and polarity.

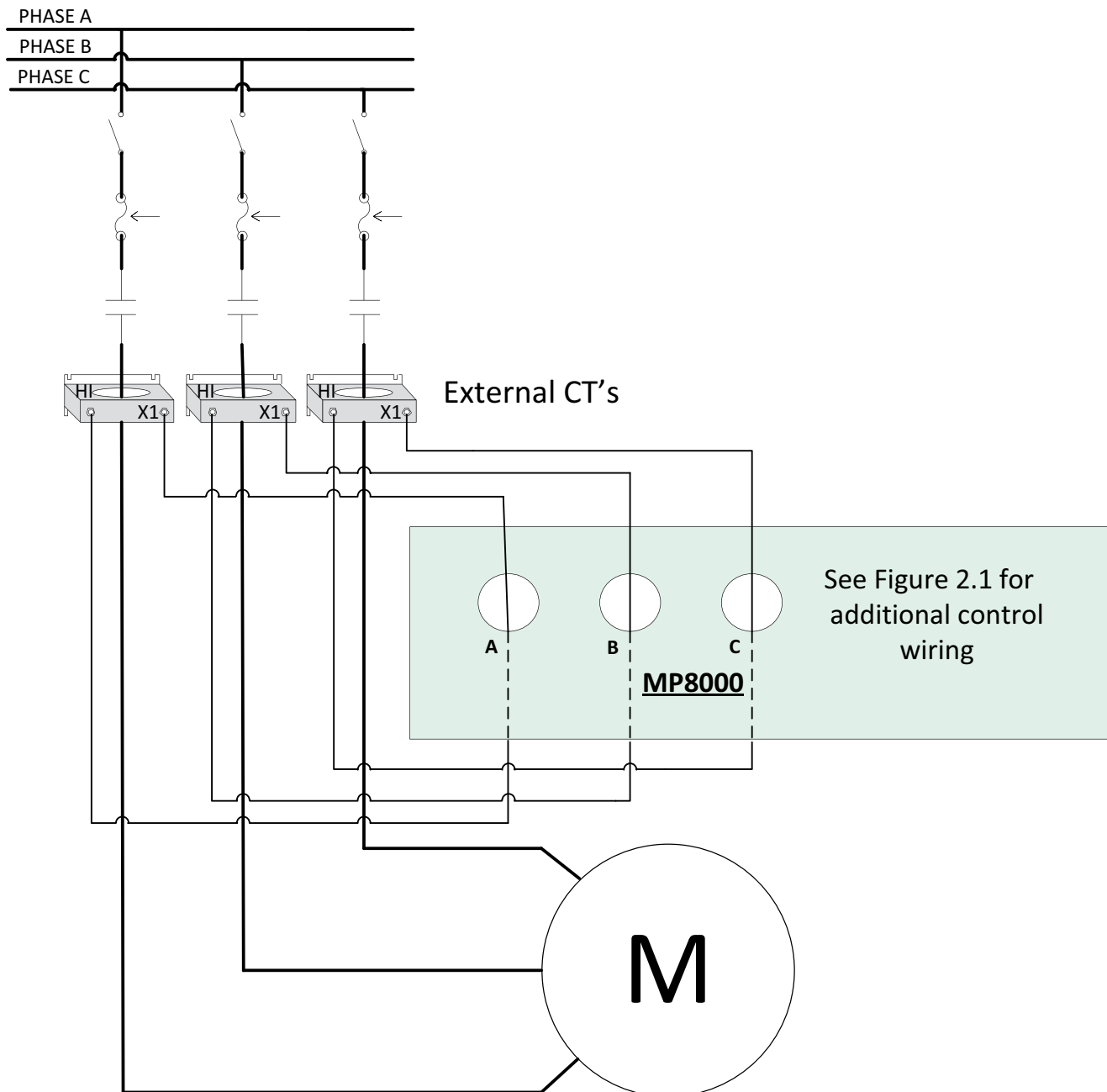

**Figure 3.6 Power wiring for three-phase motors greater than 100 FLA**

**3.6.3 Single-Phase Applications**

Refer to Figure 3.7 for single-phase motor applications.  
Refer to Sections 4.7 and 4.8 for all settings.

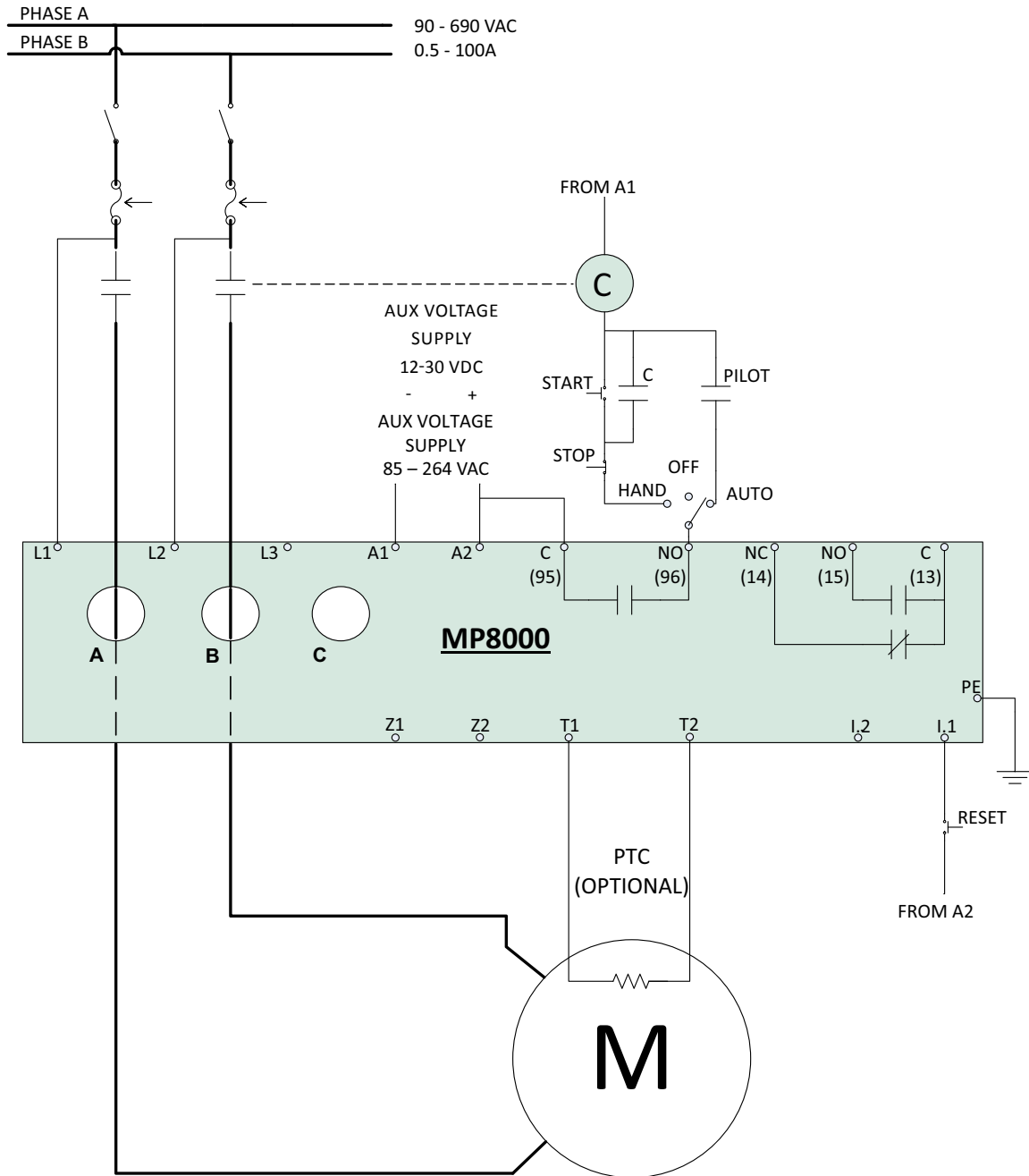

**Figure 3.7 Typical Single-Phase Motor**

## 4. LITTELFUSE MP8000 SMARTPHONE AND TABLET APP

### 4.1 Overview

The MP8000 has an iPhone/iPad and Android application. We will refer to app screens or displays as pages. All pages are scrollable.

### 4.2 Installing the Android App

The Android app can be obtained at the Google Play Store. Using the store's search tool type "littelfuse" (notice unique spelling of littel). You will see an app for the MP8000 listed.

### 4.3 Installing the iPhone/iPad App

The iPhone/iPad app can be obtained at the Apple App Store. Using the stores search tool type "littelfuse" (notice unique spelling of littel). You will see an app for the MP8000 listed.

You can watch the progress of the install by finding a red icon on one of your app pages that shows the status of the install. See Figure 4.1.

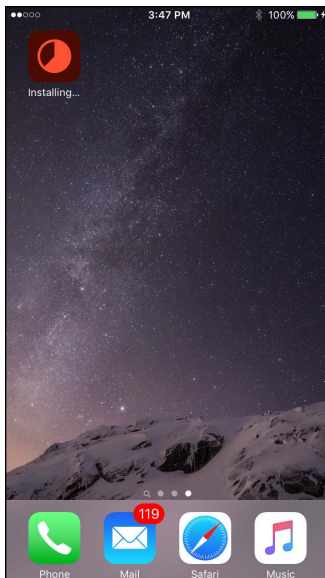

**Figure 4.1 App installing**

### 4.4 Running the Littelfuse MP8000 App

After you have installed the Littelfuse MP8000 App, a Littelfuse icon should be visible on one of your app pages. See Figure 4.2. Touching the icon starts the app.

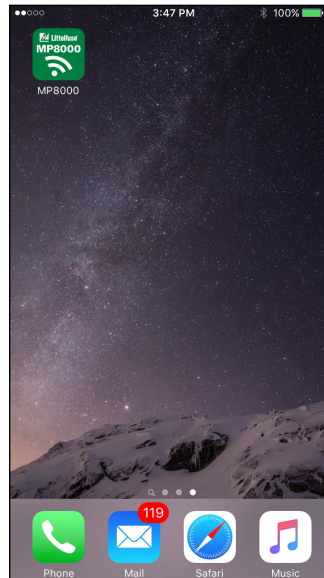
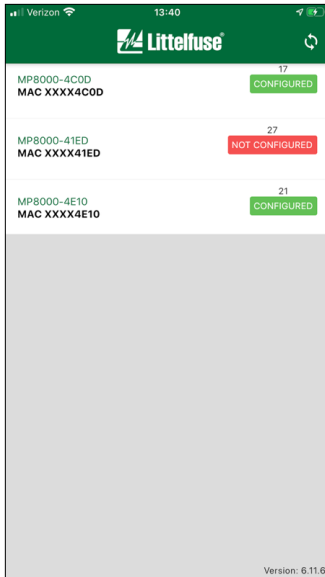

**Figure 4.2 Littelfuse MP8000 App icon**

### 4.5 Advertising Page

The advertising page displays a list of all energized MP8000's that are within range of the smartphone or tablet. This is usually up to 30 feet depending upon the smartphone/tablet used, enclosure type or the environment. MP8000's that have not been configured will be identified with a NOT CONFIGURED message with a red background as seen in Figure 4.3. MP8000's that have been configured will be identified with a CONFIGURED message with a green background as seen in Figure 4.3. The number displayed to right of the MP8000's name is a relative signal strength number. The app's version number is displayed in the lower right of the Advertising page, see Figure 4.3.

The MP8000 can be pre-programmed prior to installation by applying 115 or 230 VAC control power to A1/A2 terminals and MP8010 can be pre-programmed prior to installation by applying 12-30 VDC control power to A1/A2 terminals.



**Figure 4.3 Advertising page**

Select the MP8000 you would like to view. If it is the first time that this smartphone or tablet has accessed this MP8000 a pairing request will be presented. The pairing code for the MP8000 is located on the side adhesive label and on additional labels provided in the package. The pairing code is unique to each MP8000 and should be kept in a secure location. Pairing is only required one time per smartphone/tablet per MP8000. See Figure 4.4.

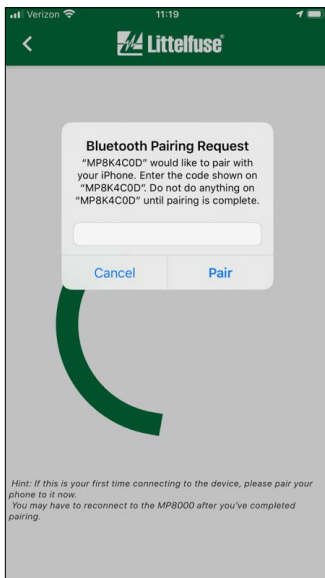

**Figure 4.4 Pairing request**

If this MP8000 has never been configured you will be asked if you want to configure the device. See Figure 4.5.

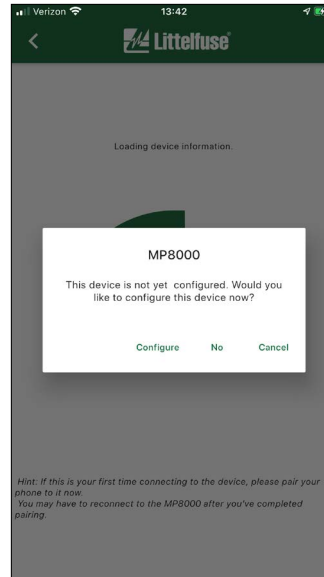
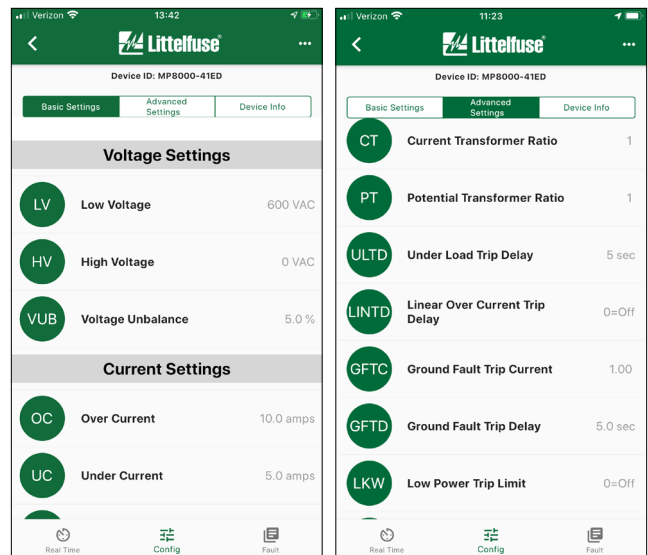

**Figure 4.5 Automated Configuration request**

If cancel is chosen you will return to the Advertising page. If No is chosen you will be taken to the Real-Time page, however you will not have access to the Fault page for this MP8000 until it is configured. If Configure is chosen you will be taken to the Basic Configuration page. See Figure 4.6. You may choose to configure/re-configure the MP8000 at any time in the future as well.

## 4.6 Configuration Pages

There are three configuration pages, Basic Settings, Advanced Settings, Device Information See Figure 4.6



**Figure 4.6 Configuration – Basic and Advanced Settings**

The first time you attempt to modify a parameter your authorization credentials will be requested. The factory default password is unique to each MP8000 and is located on the side adhesive label and on additional labels provided in the package. See Figure 4.7.

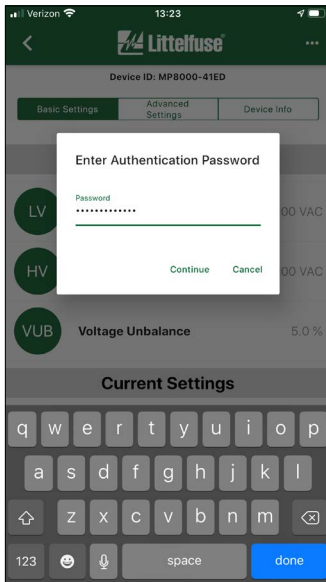

**Figure 4.7 Authentication request**

Once you have successfully provided your authorization credentials you can modify all Basic and Advanced parameters to match your systems requirements. These credentials will allow modification as long as this session of the app remains the active app. See Figure 4.8

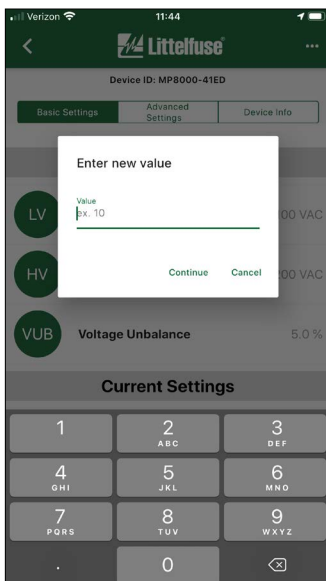

**Figure 4.8 Numeric parameter modification**

The Littelfuse MP8000 app notifies the user if the requested configuration change was unsuccessfully programmed into the MP8000 and renders a message affirming the modification. See Figure 4.9

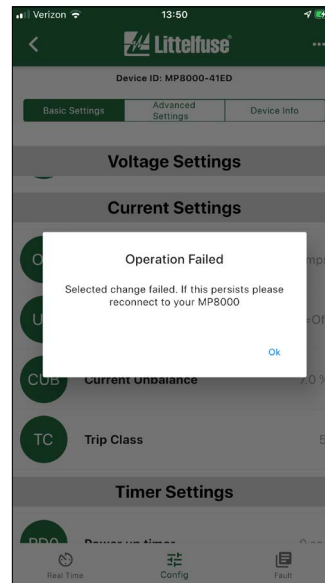

**Figure 4.9 Message for parameter modification**

## 4.7 Configuration Basic Page (Protective Features)

The following Basic Settings MUST be programmed by the user in order to provide proper protection for the application. Settings vary by situation and application and should be selected and tested for each unique installation. All parameters are actual values. See Programming Examples for recommended setup instructions. Consult the motor manufacturer for appropriate settings. Failure to program all setpoints could result in nuisance tripping or prevent the device from protecting the motor.

### 4.7.1 Low Voltage (LV)

The low voltage setting is the minimum voltage required for the motor to start. The recommended setting according to the NEMA MG1 standard is -10% of the motor’s nameplate voltage. The LV setting uses the average voltage measured.

Example: Nameplate voltage = 230 V  
 $LV = 90\% \times 230 = 207\text{ V}$

#### 4.7.2 High Voltage (HV)

The high voltage setting is the maximum voltage allowed for the motor to start. The recommended setting according to the NEMA MG1 standard is +10% of the motor's nameplate voltage. The HV setting uses the average voltage measured.

Example: Nameplate voltage = 230 V  
 HV = 110% x 230 = 253 V

#### 4.7.3 Voltage Unbalance (VUB)

Voltage unbalance is the maximum voltage unbalance allowed for the motor to start. The NEMA MG1 standard says a motor should not be operated above a 1% voltage unbalance without **derating** the motor. Most utility supplied power sources have a difficult time sustaining a 1% VUB. Voltage unbalance is calculated as follows:

$$\% \text{Voltage Unbalance} = [(\text{Maximum deviation from the average}) / \text{Average}] \times 100\%$$

Example: Measured line-to-line voltages = 203, 210, and 212. The average =  $(203 + 210 + 212) / 3 = 208.3$ . The maximum deviation from the average is the greatest difference between the average voltage (208.3) and any one voltage reading:  $212 - 208.3 = 3.7$ ,  $210 - 208.3 = 1.7$  and  $208.3 - 203 = 5.3$ . The maximum deviation from the average is 5.3, thus voltage unbalance =  $5.3 / 208.3 \times 100 = 2.5\%$ .

#### 4.7.4 Overcurrent (OC)

The overcurrent setting is the maximum allowable current that allows continuous operation without tripping the relay. This is typically set to the service factor amperage (SFA) of the motor or 100-135% of motor full-load amps (FLA). If any phase exceeds the OC setting, the MP8000 will trip according to the Trip Class (TC) settings.

#### 4.7.5 Undercurrent (UC)

The undercurrent setting is the minimum allowable current that allows continuous operation without tripping the relay. Undercurrent is typically set between 60-80% of the motor's operating current. This setting is usually adequate to detect the loss of load from pumps, broken belts, couplings, etc. The MP8000 examines average current to determine if an undercurrent trip condition exists.

NOTE: a normal motor shutdown will not cause an undercurrent trip.

#### 4.7.6 Current Unbalance (CUB)

Current unbalance is the maximum current unbalance allowable for continuous operation without tripping the relay. The same formula for calculating voltage unbalance in section 4.7.3 can be used by replacing voltage with current.

#### 4.7.7 Trip Class (TC)

Determines how quickly the MP8000 will trip when an overcurrent (overload) condition is detected.

The standard trip classes are 5, 10, 15, 20, and 30. TC can be set from 2–60, allowing the unit to follow a trip curve in-between the "standard" trip class curves shown in Figure 2.2.

The motor manufacturer should be contacted for an exact TC setting. Table 4.1 describes the trip classes, and Figure 2.2 shows the trip class curves.

**Table 4.1 Trip Class Descriptions**

TRIP CLASS	APPLICATION DESCRIPTION
5	Small fractional horsepower motors where acceleration times are almost instantaneous or where extremely quick trip times are required
10	(Fast Trip) Hermetic refrigerant motors, compressors, submersible pumps and general-purpose motors that reach rated speed in less than 4 seconds
15	Specialized applications
20	(Standard Trip) Most NEMA-rated general-purpose motors will be protected by this setting
30	(Slow Trip) Motors with long acceleration times (>10 seconds) or high inertia loads
Non-Standard Trip Classes	Trip time in seconds when any phase current is 600% of OC. Time is approximately 90% of the TC setting

#### 4.7.8 Restart Delay Zero (RD0)

RD0 is referred to as the power-up timer, in seconds. The purpose of this timer is to provide protection against power system fluctuations. The purpose of this timer is to delay the start of a motor for a period of time after good power returns. Each motor in a multi-motor environment should have this set to different values to allow each motor to start at different times after power returns to normal to avoid overloading the power system. This ensures that no two motors will be drawing startup current levels at the same time. This timer is initiated when acceptable power is applied to the L1, L2, L3 terminals, and will also be reloaded if the incoming power does not meet the LV, HV, or VUB settings when the motor is not running. When power returns to within these settings, the RD0 timer will count down and close the relay. If RD0 timer is set to 0, this timer will be disabled.



#### 4.7.9 Restart Delay One (RD1)

RD1 is referred to as the rapid-cycle timer, in seconds. The purpose of this timer is to provide protection against short cycling of the controls between motor starts. This timer is initiated after the motor has been stopped by breaking the control power. At this time the control relay is opened and the output relay will energize (the NO will close) as soon as RD1 timer expires. If RD1 is set to zero this delay will be disabled.

#### 4.7.10 Restart Delay Two (RD2)

RD2 is referred to as the motor cool-down timer, in seconds. RD2 is used to restart the motor after an operating motor trips due to OC, CUB, or HKW.

#### 4.7.11 Restart Delay Three (RD3)

RD3 is referred to as the underload restart timer, in seconds. RD3 is used to restart the motor after an operating motor trips due to UC or LKW. An example of the use of this timer is to set it to the period of time required for a well to recover. This setting varies widely by application and there is no typical setting.

#### 4.7.12 Undercurrent Restart Attempts (RU)

RU is the number of restarts the MP8000 will attempt after an underload fault before the unit locks out and requires a manual reset. This counter is cleared one minute after restarting if the MP8000 does not trip again on underload during that period. If RU is set to "0", the MP8000 will require manual resetting after all underload faults.

#### 4.7.13 Other Faults Restart Attempts (RF)

RF is the number of restarts the MP8000 will attempt after tripping on OC, CUB, or HKW before the unit locks out and requires a manual reset. This counter will be cleared one minute after restart if the unit does not trip again for the same fault condition during that period. If RF is set to "0", the MP8000 will require manual reset after tripping on OC, CUB, or HKW.

#### 4.7.14 Basic Settings Default Values

**Table 4.2 Default values for basic settings**

ACRONYM	DEFAULT	UNITS
LV	600	VAC (RMS)
HV	0	VAC (RMS)
VUB	5.0	Percent Voltage unbalance
OC	10.0	Amps (RMS)
UC	5.0	Amps (RMS)
CUB	7.0	Percent Current unbalance
TC	5	Trip Class
RD0	0	Seconds
RD1	0	Seconds
RD2	300	Seconds
RD3	300	Seconds
RU	1	Underload restart count
RF	1	CUB/OC

#### 4.8 Configuration Advanced Page (Protective Features)

The following settings are optional depending upon your application. Settings vary by situation and application and should be selected and tested for each unique installation. See Programming Examples for sample setup instructions. Failure to program all setpoints could result in nuisance tripping or prevent the device from protecting the motor.

##### 4.8.1 Current Transformer Ratio (CT)

The default value of 1 implies that the current inputs are directly from the motor with only one pass (no loops) through each window. This parameter should only be changed if you are using external CTs or if you want improved current measurement accuracy with motors having an FLA that is less than 2 amps. See Table 4.3 for examples of recommended configurations.

**Table 4.3 Common CT Ratios and CT Setting**

FULL LOAD AMPS CURRENT RANGE (AMPS)		# OF PASSES THROUGH EACH WINDOW	CT SETTING	EXTERNAL CT PRI:SEC
MIN	MAX			
0.5	2	5	5	N/A
2.0	100	1	1	N/A
101	200	1*	200	200:5
201	400	1*	400	400:5
401	800	1*	800	800:5

\* External CT Secondary

NOTE: Other CT XXX:5 Ratios can be programmed. Consult manufacturer for appropriate applications. Additional CT primaries can be used and should be sized so that the FLA of the motor is between 60-90% of the CT primary.

#### 4.8.2 Potential Transformer Ratio (PT) for Medium-Voltage Applications Greater Than 690 V ac

Refer to Figure 2.1 for control wiring. Refer to Figure 4.10 for potential transformer wiring options. Refer to Sections 4.7 and 4.8 for all settings.

This parameter should only be changed if you are using external PTs. The default value of 1 implies that the voltage inputs are a direct connection. Common ratios can be seen in Table 4.4.

NOTE: a PT ratio must be changed to accommodate the PT ratio used. Example: a PT ratio of 4160:120, program 35 for PT.

**Table 4.4 Common PT Ratios and PT Setting**

PT PRIMARY VOLTAGE	PT SECONDARY VOLTAGE	PRI:SEC = PT RATIO
2400	120	2400:120 = 20
4200	120	4200:120 = 35
4800	120	4800:120 = 40
7200	120	7200:120 = 60
8400	120	8400:120 = 70

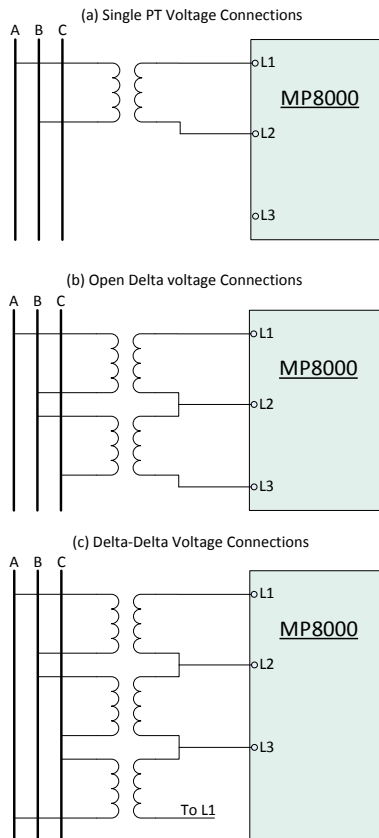

**Figure 4.10 External PT Voltage Connections (for voltages greater than 690 VAC)**

#### 4.8.3 Underload Trip Delay (ULTD)

The length of time, in seconds, the unit will allow the motor to run in an underload situation before de-energizing its relay.

#### 4.8.4 Linear OC Trip Delay (LINTD)

The length of time, in seconds, the unit will allow the motor to run if one current exceeds the OC value. This process runs in parallel with the TC process.

NOTE: LINTD is defaulted 0=off. Changing the setting to a non-0 number enables linear overcurrent trip delay.

#### 4.8.5 Ground Fault Trip Current (GFTC)

The maximum allowable current that can flow to ground before the MP8000 trips or alarms. See GFMT Section 4.8.14 for configuration of trip or alarms. This is a Class 1A/1B ground fault, not intended for personnel safety. The GFTC is defaulted 0=off. Setting a non-0 number enables ground fault and requires an external zero-sequence CT. A typical setting for GFTC is 1-4 amps of ground current. The GF test procedure in this installation instruction manual must be conducted before the device is brought online. See Section 7.

#### 4.8.6 Ground Fault Trip Delay (GFTD)

The delay time in seconds from detection of the ground fault current exceeding the GFTC value before the relay trips and/or the auxiliary relay is activated. This setting determines at which ground fault class the relay will operate.

60947 Class 1A, GEFD no inhibit current level (trip at all current levels), trip delays less than 1s

60947 Class 1B, GEFD no inhibit current level (trip at all current levels), trip delays greater than 1s and less than 5s

non-60947 GEFD beyond 5 seconds may be applicable to resistively grounded systems

#### 4.8.7 Low Power Trip Limit (LKW)

The threshold for low power trip condition. If the load drops below this kW setpoint, the relay will trip after the ULTD delay expires. LKW is defaulted 0=off. A non-0 setting will enable this feature.

#### 4.8.8 High Power Trip Limit (HKW)

The threshold for high power trip condition. If the load exceeds this kW setpoint, the relay will trip after the HPTD delay expires. HKW is defaulted 0=off. A non-0 setting will enable this feature.

#### 4.8.9 High Power Trip Delay (HPTD)

The delay, in seconds, before a trip condition occurs once the HKW threshold has been exceeded.

#### 4.8.10 Stall Percentage (STLP)

This parameter sets the current threshold for the jam/stall condition. A jam/stall condition exists if any phase current is greater than or equal to the Jam/Stall percentage of the OC setting. Example: STLP=400%, OC=50A. Stall trip point=4\*50=200A.

#### 4.8.11 Stall Trip Delay (STTD)

This parameter is the time that the jam/stall condition must be present before the MP8000 trips on overcurrent.

#### 4.8.12 Stall Inhibit Delay (STID)

This parameter is the amount of time that the Jam/Stall feature is inhibited after each motor start.

#### 4.8.13 Advanced Settings Default Values

**Table 4.5 Default values for advanced settings**

ACRONYM	DEFAULT	UNITS
CT	1 (no CTs)	CT Primary:5
PT	1 (no PTs)	Turns Ratio
UCTD	5	Seconds
LINTD	0=Off	Seconds
GFTC	0=Off	Amps (RMS)
GFTD	5	Seconds
LKW	0=Off	KW
HKW	0=Off	KW
HPTD	60	Seconds
STLP	0=Off	Percentage
STTD	5	Seconds
STID	0	Seconds

#### 4.8.14 Hardware Configuration Fields Single-Phase Motor (SPM)

Enabling this feature allows single-phase motors to be monitored. The following changes in settings are made by enabling this setting:

1. Voltage unbalance and voltage single-phase protection is disabled
2. Phase sequence protection is disabled
3. Contact failure trip disabled
4. Only voltage across L1 and L2 is monitored. HV and LV settings are still active.

5. Only conductors in A and B are measured. Measured current average calculated as (A+B)/2.
6. Current unbalance and current single-phase trip disabled
7. Reference Figure 3.7 for appropriate wiring

#### Single-Phase PT Enable (SPT)

Enabling this feature allows a single potential transformer to be used on a 3-phase motor. Enabling single-phase PT disables the following functions: phase rotation protection, voltage unbalance/single-phase, and contactor failure. See Figure 4.10, the (a) drawing for the PT connections.

#### PTC Enable (PTC)

Enabling this feature implies the following:

1. An external PTC is properly connected to the MP8000-T1/T2 terminals. PTC will trip according to the specifications. See Figure 2.1
2. The MP8000 will trip if the PTC registers overheating conditions.

#### ACB phase rotation (ACB)

Enabling this feature changes the expected wiring sequence connected to L1, L2, L3 from the default of ABC to ACB.

#### Current Only Mode (COM)

Enabling this feature allows for use without voltage measurements. L1, L2, and L3 are not necessary in this configuration. While in Current Only Mode of operation, the Low Voltage, High Voltage, Voltage Unbalance, Phase Sequence, Low Power and High Power functions are disabled. There is also no instantaneous or metered power measurements given.

**Table 4.6 Hardware Configuration fields**

NAME	ACRONYM	DESCRIPTION	DEFAULT
Single-Phase Motor	SPM	Enable if this is a single-phase motor. See Figure 3.7 for special wiring considerations.	disabled
Single-Phase PT	SPT	Enables a single PT to be used on a 3-phase motor.	disabled
PTC Enable	PTC	An external PTC is properly connected to the MP8000.	disabled
ACB phase rotation	ACB	ACB phase rotation is expected if enabled	disabled
Current Only Mode	COM	Enabling removes all voltage measurements and fields requiring voltage measurements	disabled

#### 4.8.15 AUX Relay Configuration

##### Ground Fault Motor Trip (GFMT)

Ground fault detection is enabled in GFTC. The GFMT setting will decide if the motor is tripped from the ground fault, or if the auxiliary relay is energized as an alarm. Enabling GFMT will trip the control relay on ground fault, and disabling GFMT will energize the auxiliary relay on ground fault

##### AUX Failsafe Mode (AFS)

Enabling the feature allows the auxiliary relay to operate in a failsafe manner.

1. If there are no holdoff or fault conditions present, the auxiliary relay will be energized.
2. If there is a holdoff or fault condition present, the auxiliary relay will be relaxed.

##### AUX Indicate Holdoff (AIH)

Enabling this feature allows the auxiliary relay to be affected by the presence of a holdoff condition on the system.

1. When a holdoff condition is present, the auxiliary relay will be energized.
2. When no holdoff condition is present, the auxiliary relay will be relaxed.

\*These states operate in the inverse if AUX Failsafe Mode is enabled

##### AUX Indicate Fault (AIF)

Enabling this feature allows the auxiliary relay to be affected by the presence of a fault condition on the system.

1. When a fault condition is present, the auxiliary relay will be energized.
2. When no fault condition is present, the auxiliary relay will be relaxed.

\*These states operate in the inverse if AUX Failsafe Mode is enabled

**Table 4.7 AUX Relay Configuration fields**

NAME	ACRONYM	DESCRIPTION	DEFAULT
Ground Fault Motor Trip	GFMT	Ground fault detection is enabled in GFTC. GFMT will trip the motor control relay if enabled or auxiliary relay alarm is disabled.	enabled
AUX Failsafe Mode	AFS	Enables the auxiliary relay to be used in a failsafe configuration	disabled
AUX Indicate Holdoff	AIH	Auxiliary relay can be made to indicate the presence of a holdoff condition	disabled
AUX Indicate Fault	AIF	Auxiliary relay can be made to indicate the presence of a fault condition	disabled

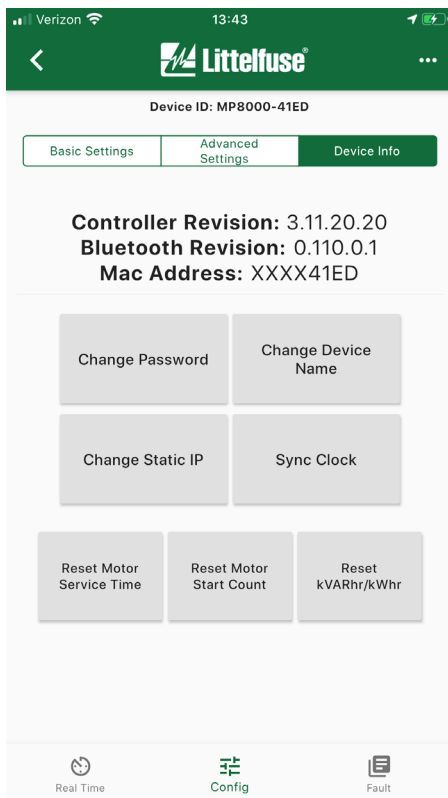

## 4.9 Configuration Device Info Page

The following features can be used to affect aspects of the MP8000 that are not directly related to the protection capabilities of the unit. Refer to figure 4.6

### 4.9.1 Controller Revision

The current version of programmed controller

firmware is displayed here

### 4.9.2 Bluetooth Revision

The current version of programmed BLE firmware is displayed here

### 4.9.3 Mac Address

The last two octets of the unit's MAC address are displayed here

### 4.9.4 Change Password

Momentarily touching the Change Password button on the MP8000 app will allow an authorized user to change the password from the default or previously changed password. The user will need to enter the new password twice to verify it was properly entered. The new password will take effect the next time any user connects to this MP8000.

### 4.9.5 Reset Password

To reset the MP8000 back to its original default password, follow the steps below:

1. Locate the authorization key, which is shipped with the product (the Reset Password sticker that should be kept in a secure location).
2. If a normally-open manual reset button has been installed between A2 and I.1 as shown in Figure 2.1, proceed to step 4.
3. If a normally-open manual reset button as shown in Figure 2.1 is not installed, the user will need to be ready to momentarily jumper between the A2 and I.1 terminals at the appropriate time during this process.
4. Ensure that the LEDs on the front of the MP8000 are visible.
5. Press and hold for a second, the Change Password button on the MP8000 app to cause the Reset Password authorization window to open.
6. Enter the authorization key on the MP8000 app to reset the password.
7. If the authorization key is entered correctly, the blue Bluetooth LED on the MP8000 will begin to blink and a popup showing a 10 second countdown timer will appear on the MP8000 app. If the blue Bluetooth LED does not blink and the 10 second countdown timer does not appear, check to make sure you have the correct authorization key and repeat the above steps.
8. During the 10 second countdown period, press the normally-open manual reset button (if

installed) or momentarily jumper between the A2 and I.1 terminals.

9. Once successfully completed, the blue Bluetooth LED will stop blinking, and the MP8000 and after the count down completes, the app will return to the “advertising page”
10. Reconnect to the MP8000 using the Littelfuse MP8000 app.
11. The default password may now be used for changing configuration settings.

#### 4.9.6 Change Device Name

Touching this button enables the user to change the name displayed for this MP8000. The name can be seen at the top of the screen and on the advertising page for each unit.

#### 4.9.7 Change Static IP

Touching this button enables the user to change whether the unit will use DHCP to acquire its IPv4 settings or if the user will set them statically. Refer to section 4.13.3.

#### 4.9.8 Sync Clock

Touching this button allows the user to synchronize the unit's real time clock to the UTC which is then adjusted based on the unit's installation location. If the unit determines that its real time clock is already set to within  $\pm 5$  minutes of actual UTC time, no action will be taken.

#### 4.9.9 Reset Motor Service Time

Touching this button allows the user to reset the accrued Motor Service Time (MST) of each unit. Refer to section 4.10.14

#### 4.9.10 Reset Motor Start Count

Touching this button allows the user to reset the accrued Start Count (SCNT) of each unit. Refer to section 4.10.15

#### 4.9.11 Reset kVARhr/kWhr

Touching this button allows the user to reset the accrued energy usage meters of each unit. Refer to section 4.10.10

### 4.10 Real-Time Page (Measurements & Monitoring)

The Real-Time page provides updates every second for all the motor's vital measurements. See Figure. 4.12. If something other than a Status of OK is displayed

on the app's Real-Time page, see the troubleshooting section for more information.

#### 4.10.1 Device ID

The name of the MP8000 you are connected to is displayed here.

#### 4.10.2 Reset Relay

This button requires the user to enter the correct setpoint password. It resets the relay from a manual reset, or will bypass all active timers, allowing it to energize and supply power to the motor.

#### 4.10.3 System Status

This field displays the status of the relay. Hold-off and trip conditions are displayed here.

#### 4.10.4 Active Timer

If any delay timer is active, the remaining time is displayed here. Also the identity of which delay timer is active (RD0, RD1, RD2, or RD3).

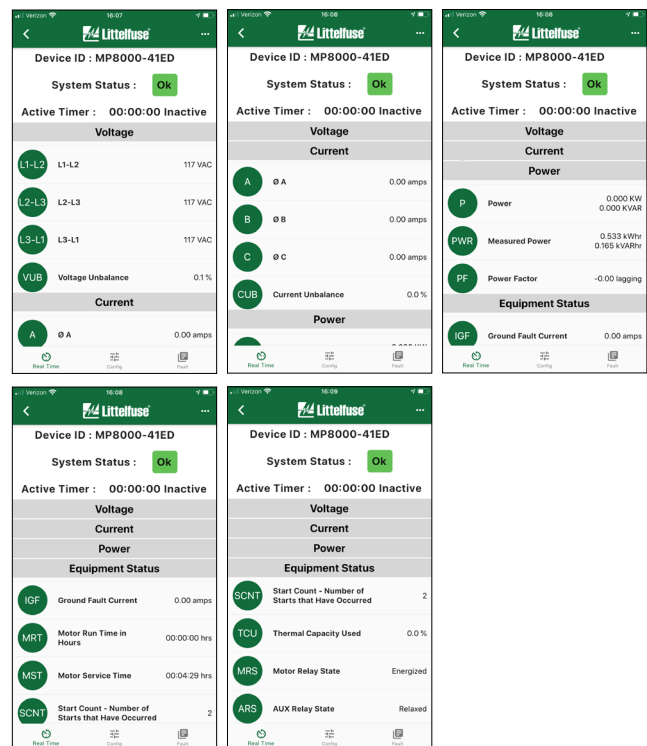

Figure 4.12 Real-Time Page

#### 4.10.5 Line-to-Line Voltage

The input voltages, L1, L2, and L3, are measured and displayed as line-to-line RMS AC voltages.

#### 4.10.6 Voltage Unbalance

Voltage unbalance (VUB) is the NEMA voltage unbalance percentage

**4.10.7 Line Current**

Current, A, B, and C are measured and displayed as RMS AC line current.

**4.10.8 Current Unbalance**

Current unbalance (CUB) is the NEMA current unbalance percentage.

**4.10.9 Power**

Instantaneous Power (P) is displayed in both Kilowatts and Kilovolt-Ampere Reactive (kVAR).

**4.10.10 Measured Power**

Measured Power (PWR) is the total, accumulated energy consumption of the connected load and is displayed in both kWhr and kVARhr values.

**4.10.11 Power Factor**

The Power Factor (PF) is displayed in decimal form. The Power Factor (PF) is obtained by taking the cosine of the angular difference between the voltage and current measurements.

**4.10.12 Ground Fault Current**

The measured Ground Fault Current (IGF) through the externally connected, zero-sequence CT, is displayed in amps.

**4.10.13 Motor Run Time in Hours**

Motor RunTime (MRT) is the amount of time the motor has ran since the last start (hours:minutes:seconds). This value is reset to zero on every motor start.

**4.10.14 Motor Service Time**

Motor Service Time (MST) is the total accumulated time the connected motor load has been running (hours:minutes:seconds)

**4.10.15 Start Count**

Start Count is the number of motor starts that have occurred.

**4.10.16 Thermal Capacity**

The displayed value is Thermal Capacity Used (TCU). It is a percentage. If the TCU is at 100% the motor has used all of its thermal capacity and will be shut down as an overcurrent fault, to allow the motor to cool off.

**4.10.17 Motor Relay State**

The current status of the Motor Relay is displayed here as either Energized or Relaxed.

**4.10.18 AUX Relay State**

The current status of the Auxiliary Relay is displayed here as either Energized or Relaxed.

**4.11 Fault Page**

The main Fault page is scrollable and lists up to 1,000 faults with the most recent faults first. See Figure 4.12.

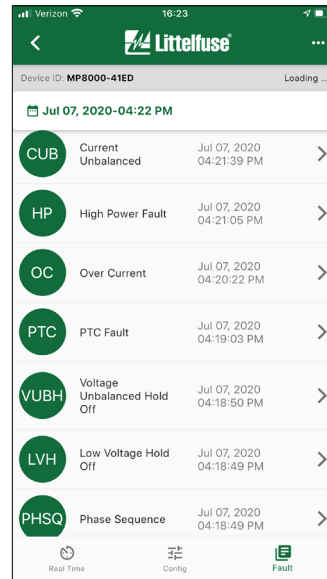

Figure 4.13 Main Fault Page

NOTE: fault screens are not accessible prior to configuration of the MP8000.

The faults can be scrolled or a date can be entered if you want to jump to that date. Just touch the date bar and a calendar is displayed. See Figure 4.13.

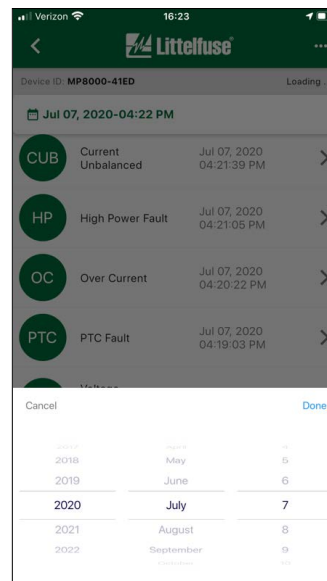

Figure 4.14 Fault Calendar

All vital measurements for each fault can be viewed by touching the fault of interest. See Figure 4.14.

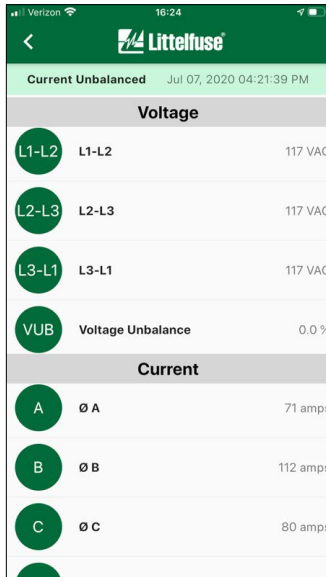

Figure 4.15 Detailed Fault Page

## 4.12 Time Settings

The onboard battery will last for approximately 8 months when not connected to power. Once connected to power, the battery will be fully recharged in approximately 48 hours. If the battery has been depleted, updating the real time clock is required to ensure the fault date information is correct. Refer to section 4.9.8

### MP8000 software:

Connect to the device. It automatically updates the runtime clock upon connection.

### Phone App:

1. Connect to the device.
2. Select either the Update RTC clock button on the configuration > device info page, or another option in the settings that prompts you to enter the password.
3. After a successful authentication password the RTC Clock will have been automatically updated.

## 4.13 Setting the IP Address

The MP8000 ships with DHCP IPv4 as the default. To define a static IP address, the MP8000 must have control power and either a connection to the MP8000 via Bluetooth or via a network cable connection to a host computer. The network connection can be with or without a DHCP server.

### 4.13.1 DHCP Assigned IPv4 Address

The default configuration of the MP8000 is to accept an IP address from the DHCP server of the network that the MP8000 is connected. With this default configuration, every time the MP8000 is powered on it will request an IP address from the DHCP server. This IP address may not be same every time as the DHCP server maintains what IP address are used on the network. Also, the IP address may change from time to time based on how the DHCP server has been configured. Please refer to your system administrator on this.

### 4.13.2 Point to Point IP Address Assignment (no DHCP)

If you attached the MP8000 directly to a computer that has not been configured as a DHCP server or to a network that does not have a DHCP server available, then the MP8000 will assign itself its own IP address based on its MAC address.

Each MP8000 MAC address is defined with the following format: AA:BB:CC:DD:EE:FF

If no DHCP server is available, the MP8000 will assign itself the following IPv4 address: 10.106.EE.FF

An example would be:

- MAC address: 00:21:6F:00:4C:04
- Convert the hexadecimal value of 0x4C to decimal format is 76
- Convert the hexadecimal value of 0x04 to decimal format is 4
- The MP8000 will use the IP address of: 10.106.76.4

### 4.13.3 Changing IPv4 Settings

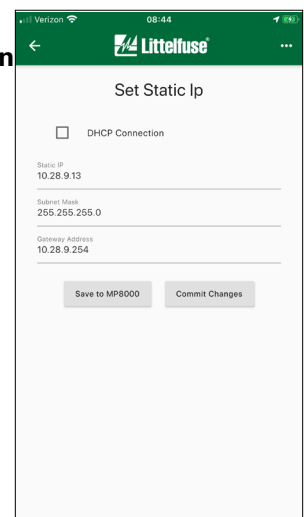



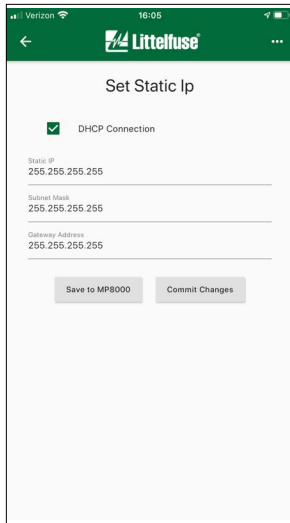

**Figure 16 Setting the IP Address**

### **Static IP**

1. Determine the proper IPv4 address, Subnet Mask, and Default Gateway to allow for communication with the connected network.
2. In the Device Info page, touch the Change Static IP button. Refer to Figure 4.11.
3. Enter the desired IPv4 address, Subnet Mask, and Gateway Address into the appropriate areas.
4. Press the Save to MP8000 button.
5. Press the Commit Changes button.
6. Unit will be configured with the user selected IPv4 settings.

### **DHCP Operation**

1. In the Device Info page, touch the Change Static IP button. Refer to Figure 4.11.
2. Check the box labeled DHCP Connection.
3. Press the Save to MP8000 button.
4. Press the Commit Changes button.
5. Unit will receive its IPv4 settings from the connected, DHCP enabled network.

## 5. PC INTERFACE

The PC interface is provided through the Ethernet connector (RJ-45). It supports ModbusTCP, Ethernet FTP commands, and Ethernet/IP.

Please see URL for the MP8000 programmer's guide for information regarding memory maps, commands, and all information for writing custom interfaces.

NOTE: This interface is secured by the user. That is, anyone who has physical access to the Ethernet interface can modify all configuration parameters.

Additionally, a program, titled MP8000 Software, which supports the MP8000 and can be used over this interface, is available at: [www.littelfuse.com/MP8000](http://www.littelfuse.com/MP8000)

The MP8000 Software runs on Windows 7 or higher. The user can select an MP8000 unit from a list on the left panel of the screen. That unit's parameters will be displayed in the right panel. A screen shot of the program can be seen in Figure 5.1. All real-time information, setpoint changes, and fault information can be viewed using this software program.

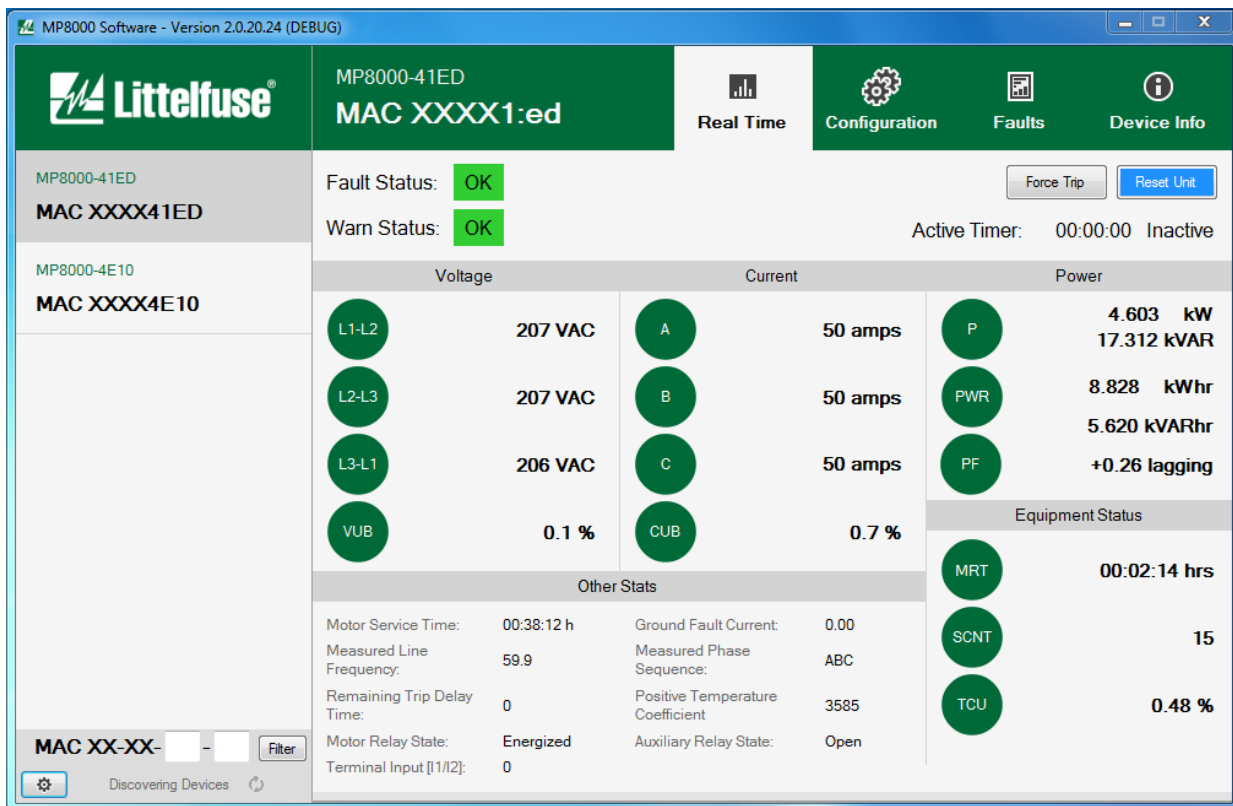

Figure 5.1 MP8000 Software

## 6. TROUBLESHOOTING

### 6.1 Overview

The Real-Time page displays System Status near the top of the page. Table 6.1 provides some common fault conditions and possible solutions.

**Table 6.1 Faults and suggested solutions**

PROBLEM	SOLUTION
Low Voltage, High Voltage, or Voltage Unbalanced	The incoming voltage is not within the limits programmed in the LV, HV, and VUB settings. Use the Real-Time page to view the actual values. Either correct the incoming voltage or adjust the LV, HV, and VUB settings.
Reverse-Phased	The voltage inputs are reverse-phased. If this is the initial start-up, there are two solutions. Either "Enable ACB Phase Rotation" in advanced settings in the Littelfuse MP8000 app, or swap any two of the leads connected to L1, L2, or L3 on the MP8000 to correct the problem. If the overload relay has been previously running, the power system has been reverse-phased. Check the phase sequence of the incoming power lines. <b>Note:</b> L1 must be tapped from conductor Phase A, L2 from B, and L3 from C for correct power measurements on remote communications.
Single-Phase, CUB, OC, LIN, Stall	The overload relay has tripped on the fault shown on the display and is timing down RD2 before restarting. No further action is required.
Manual Reset Single-Phase, CUB, OC, LINTD	The unit has tripped on the fault shown and a manual reset is required because of the programmed setting in RF. Check the system for problems that would produce the single-phase, overcurrent or current unbalance fault, such as a jam.
UC	The overload relay has tripped on undercurrent and is counting down RD3 before restarting. If undercurrent is not a normal condition for this installation, check for broken shafts, broken belts, etc.
Manual Reset UC	The unit has tripped on undercurrent and a manual reset is required because of the setting in RU. Check the system for problems that would produce a loss of load such as a broken belt or a lack of liquid to pump.
Contactor Failure	The unit has tripped on current single-phasing, but was not single-phased by the incoming voltage. Check for damaged contacts or loose or corroded wiring connections.
Ground Fault	A ground fault current greater than the programmed GF value has been detected. Check the motor for insulation breakdown. A manual reset is required to clear this message.
Low Power	The overload relay has tripped on low power (LKW) and is timing down RD3 before restarting. If LKW is not a normal condition for this installation, check for loss of liquid, closed valves, broken belts, etc.
Manual Reset Low Power	The unit has tripped on low power and a manual reset is required because of the setting in RU. Check the system for problems that would produce a loss of load like a broken belt or a pump is out of liquid.
High Power	The unit has tripped on high power (HKW) and is timing down RD2. Check for a high power condition.
Manual Reset High Power	The unit has tripped on high power and requires a manual reset because of the setting in RF.
PTC	The PTC has detected a thermal over-temperature condition. The motor needs to cool down. Check PTC connections. Check for other overheating conditions such as contamination, failed fans, overload, etc.
Phone will not pair/connect or disconnect from the device	<p>Some Android phone models may occasionally require the user to manually "forget" or "unpair" the MP8000 device. If you experience a "device disconnected" message immediately after you attempt to select (connect) to a particular MP8000. You may need to perform a manual unpairing ("forget" or "unpair") of the device with the following steps:</p> <ol style="list-style-type: none"> <li>Settings</li> <li>Bluetooth</li> <li>Select the MP8000 that is disconnecting</li> <li>Select the "Forget" option / "Unpair" option</li> </ol> <p>Then, in the MP8000 app</p> <ol style="list-style-type: none"> <li>Select the MP8000</li> <li>It will ask for pairing code; enter the correct pairing code</li> </ol> <p>Things should work normally now. If you experience this often make sure you are upgraded to the latest updates for your phone. You may be missing an update that fixes a Bluetooth Low Energy problem.</p>
Fault dates are incorrect	Follow the "Time Settings" steps in section 4.10.

## 7. GROUND FAULT TESTING PROCEDURE

**A ground fault test must be performed before installing the MP8000 as required by UL1053 and NEC, ANSI/NFPA 70.**

1. Disconnect power.
2. Connect L1, L2, L3, A1, A2, Z1, Z2, as shown in Figure 7.1. The ground fault testing can be done with or without the motor running.
3. Program the desired parameters into the unit. For test purposes, set GFTD and GFTC to the minimum allowed setting for the Class you want to implement. Also enable GFMT (Ground Fault Motor Trip).
4. Construct the circuit, using an AC power supply. This circuit simulates a ground fault condition by generating a current in one of the phases. Alternate test circuits may be used. The only requirement is the current through the Zero-Sequence Current Transformer must be between 115% and 150% of the GFTC setting.
5. The values of V and R will be determined by the current required to generate a GF trip condition:  $I = V_{rms}/R$ , where I = 115% of GFTC setting.
6. Apply power to the test circuit.
7. Energize the test circuit by pushing and holding the test pushbutton until the unit trips (within 8.5 seconds). The Real-Time display should show "Ground Fault" as the Status and the NO contacts should be open. Release the NO pushbutton.
8. The results of the test are to be recorded on the test form provided below. The form should be kept by those in charge of the building's electrical installation in order to be available to the authority having jurisdiction.
9. Confirm programmed parameters and proceed with installation instructions.

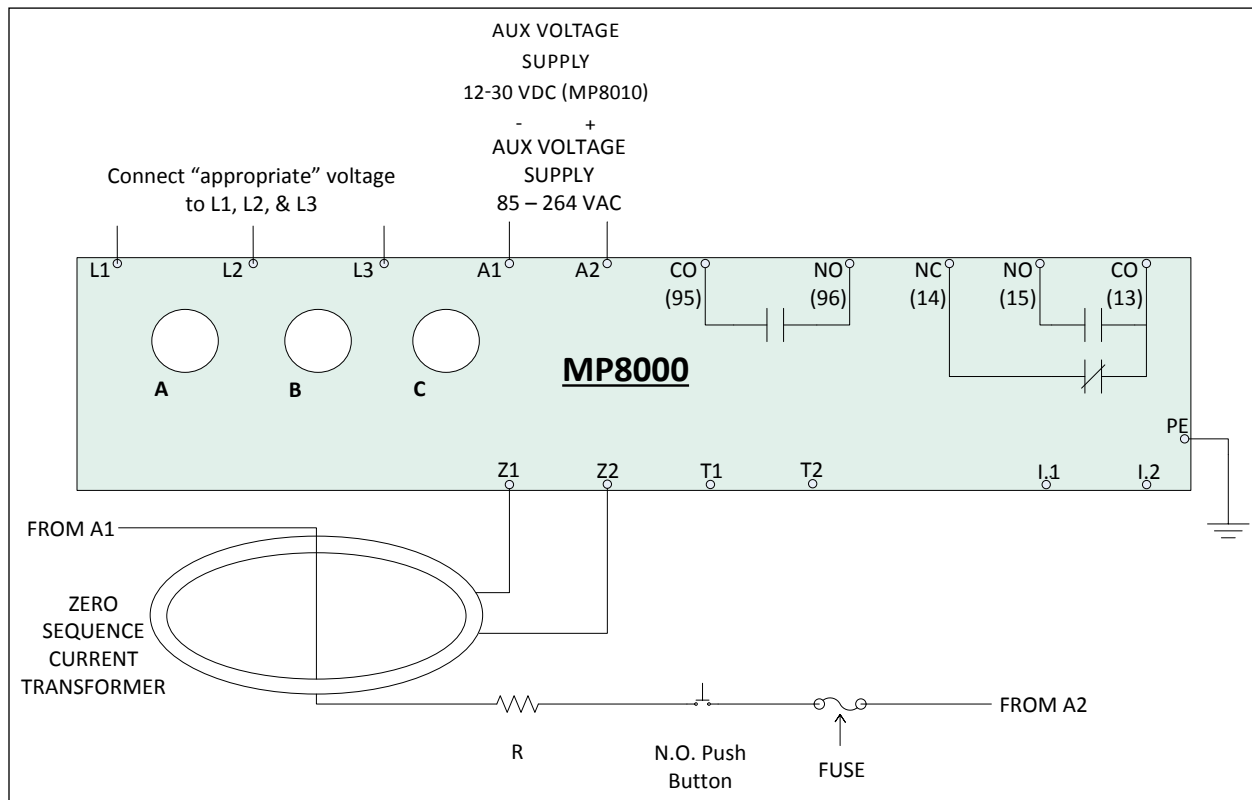

**Figure 7.1 Ground Fault Testing**

GROUND FAULT TEST RESULTS\*

Date	Performed by	Results	Location
------	--------------	---------	----------

## 8. APPENDIX

### SETTING UP THE PLC PROJECT PROCEDURE

NOTE: These instructions only apply to Rockwell Automation software and Rockwell/Allen-Bradley PLCs. Other software suites and PLCs may require their own unique methods of setup.

1. First open the Studio 5000 software by double-clicking the shortcut icon on the desktop



2. Select "New Project" in the "Create" menu

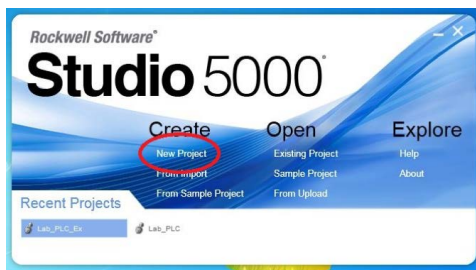

3. Select the correct PLC controller type from the list, give the project a name, and select a location where the project will be stored

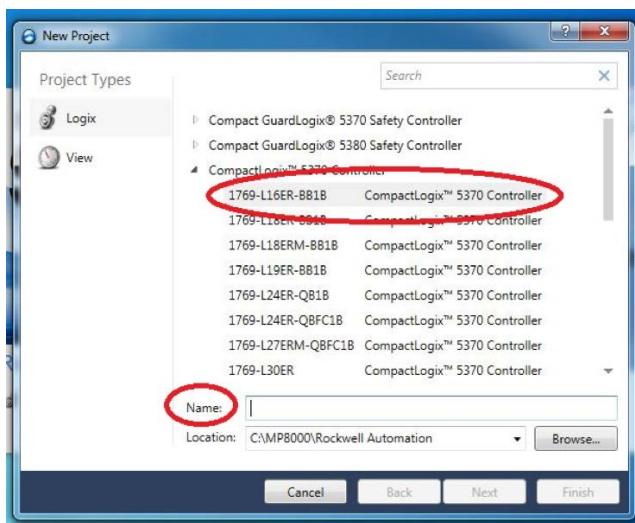

4. Select the revision of the controller code, the number of "Expansion I/O" modules, and the level of "Security Authority" desired

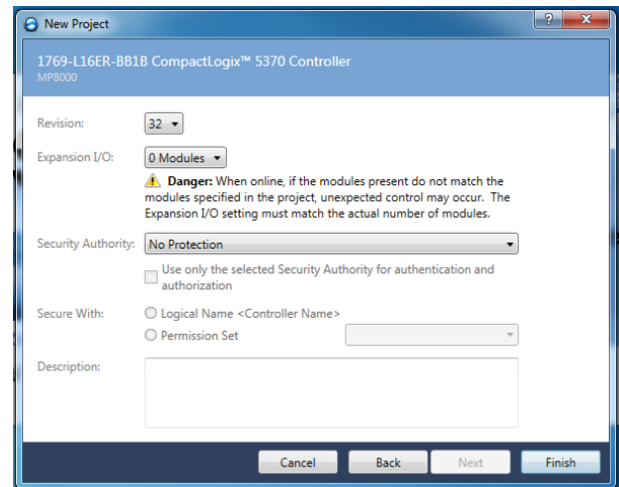

5. Click the "Finish" button
6. The newly created project will open in the Studio 5000 environment
7. Add the MP8000 EDS file to the Studio 5000 Logix Designer project
8. From the TOOLS menu, select EDS Hardware Installation Tool

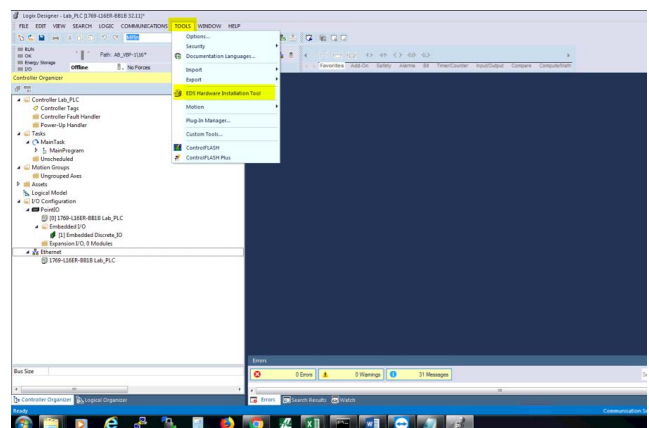

9. The Rockwell Automation EDS Wizard will open

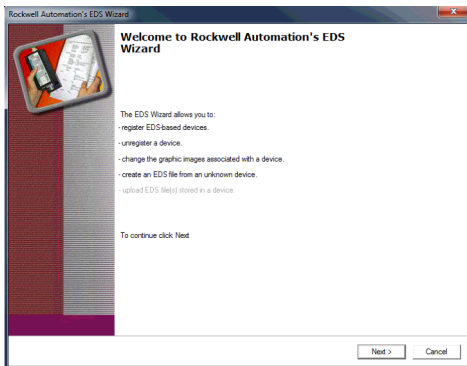

10. Click the "Next" button

11. Select the radial button next to "Register an EDS File"

12. Click the "Next" button

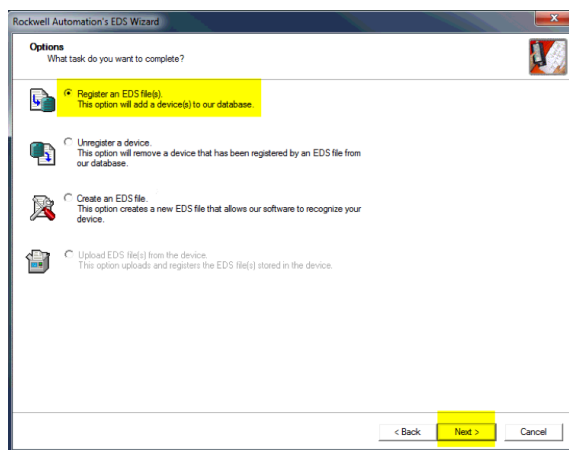

13. On the next screen, click the radial button next to "Register a single file"

14. Use the "Browse" button to point the wizard to the location of the MP8000.eds file

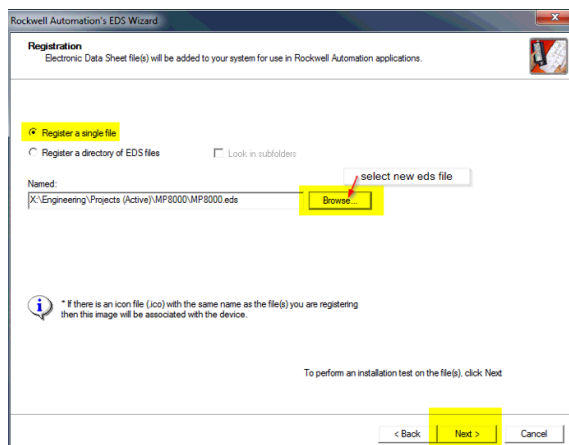

15. Click the "Next button" to begin an installation test of the EDS file

16. The wizard will display the results of the installation test of the EDS file

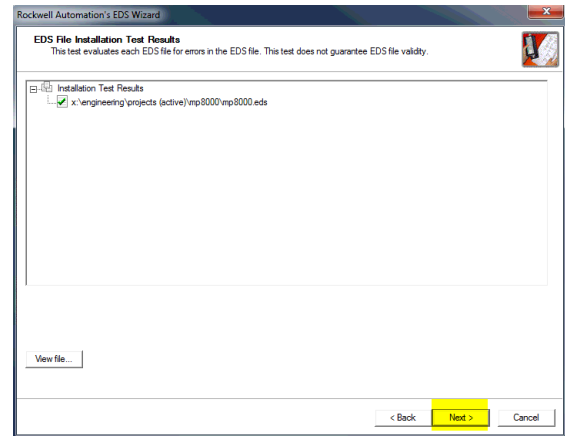

17. Click the "Next" button

18. Now the wizard will allow you to change the icon shown for the EDS file

19. Click the "Change icon..." button

- If the Littelfuse icon is already shown, click the "Next" button and skip to step 22

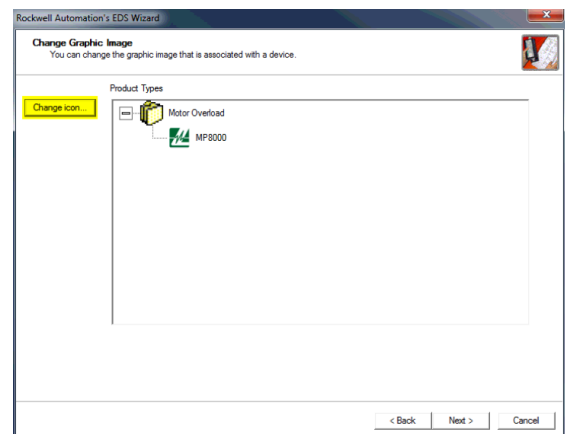

20. The "Change Icon" screen will appear

21. Click on the "Browse" button on navigate to the location of the Littelfuselcon.ico file

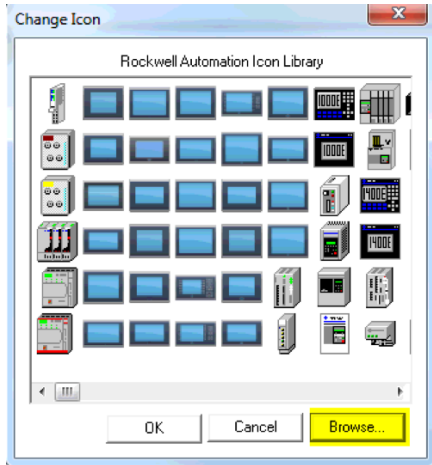

22. After you click the "Open" button, the wizard will show the "FinalTask Summary" screen

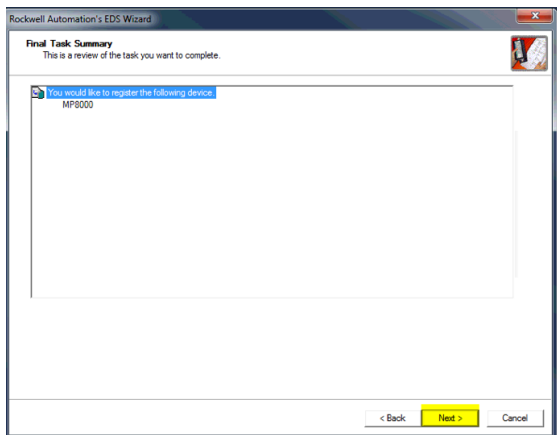

- 23. Click the "Next" button if everything is proper and correct
- 24. Click the "Finish" button to complete the EDS file installation
- 25. To begin working with the newly registered EDS file, right-click I/O Configuration->Ethernet in the tree-view of the left pane of the Logix Designer window and select "New Module..."

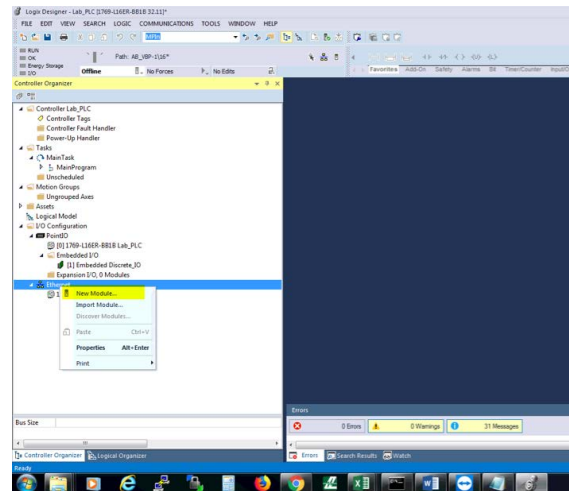

- 26. The "Select Module Type" window will open
- 27. In the "Enter Search Text for Module Type..." field, enter the search text "MP8000"

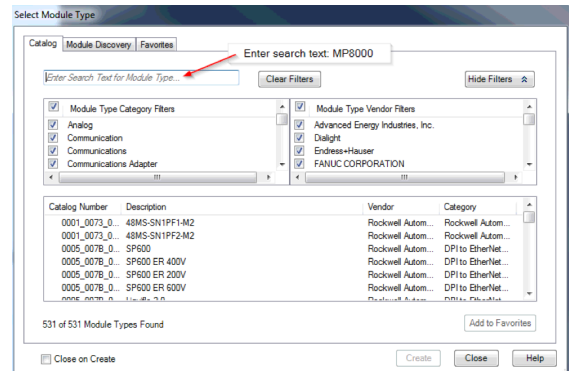

- 28. Select the MP8000 catalog entry, then press the "Create" button"
  - The correct entry will have the Product Code of 8003 (hex 1F43) shown in its catalog number

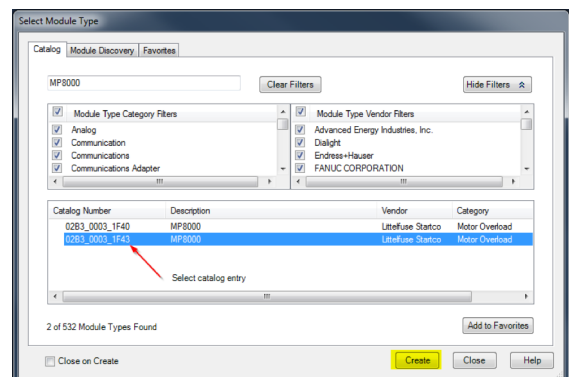

29. Add a "Name" field, enter the static IP address of the MP8000, and press the "Change..." button

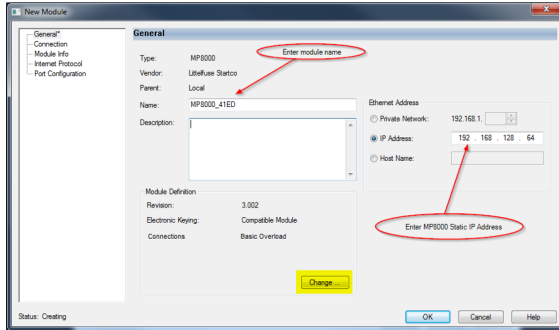

34. Ensure that the correct Electronic Keying and Connections types are displayed in the "New Module" window, then press the "OK" button

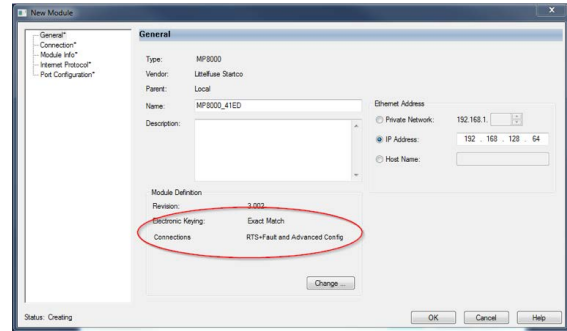

30. Use the drop-down menu to select the type of "Electronic Keying" you would like to use

- Exact Match, Compatible Module, or Disable Keying

31. Click on the "Basic Overload" selection to reveal the drop-down menu to determine connection

- Select "RTS+Fault and Advanced Config"

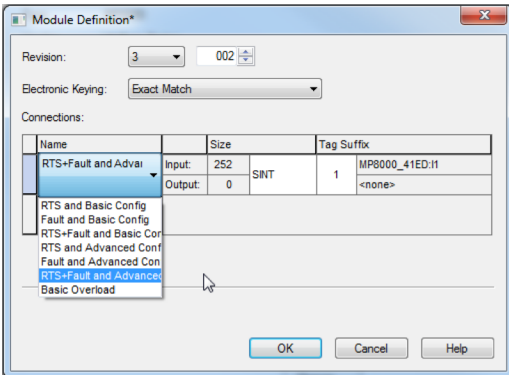

32. Click the "OK" button

33. Logix Designer will ask you if you would like to "Change module definition," select "Yes"

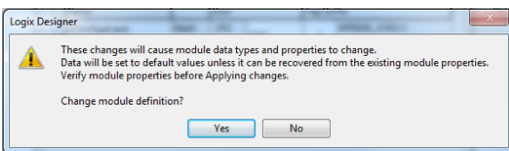

35. Close the "Select Module Type" window

36. The newly created module will now appear in the tree-view panel in the I/O Configuration -> Ethernet of the project

37. In the tree-view panel, right-click "Assets -> Data Types -> User-Defined" and select "Import Data Type..."

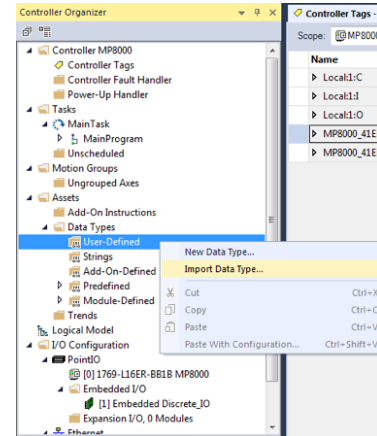

38. In the "Import Data Type" window, navigate to the location of a previously created Data-type

39. Highlight the desired .LSX file and then click the "Open" button

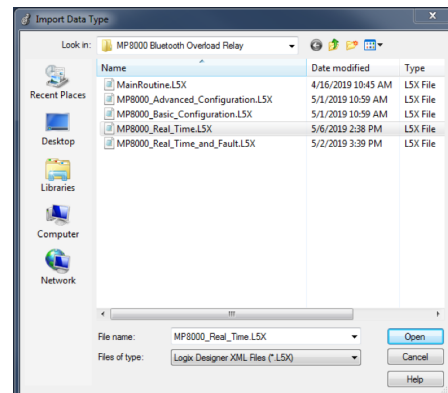



40. Add a "Name" field, enter the static IP address of the MP8000, and press the "Change..." button

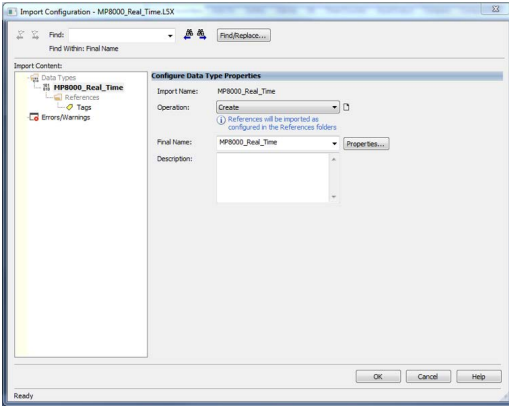

41. In the tree-view panel, right click "Controller Tags" and select "New Tag..."

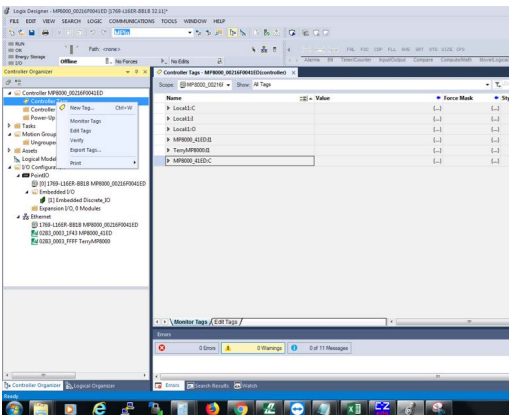

42. The "New Tag" window will open

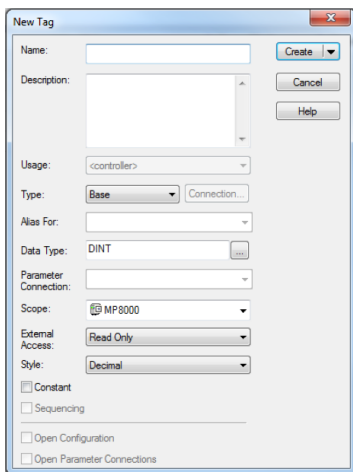

43. In the "Name" field, give the tag a unique identifier

44. In the "Data Type" field, click the "..." button and scroll down in the list until you find the correct data type

45. Click the "Create" button

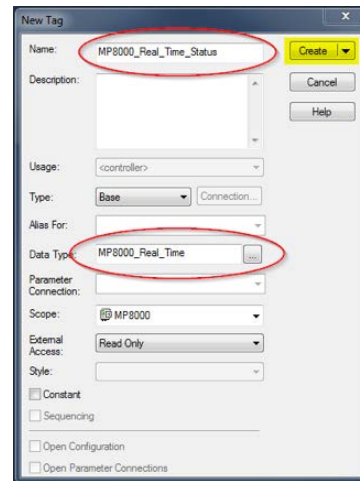

46. In the tree-view panel, expand Tasks -> Main Task -> Main Program -> Main Routine

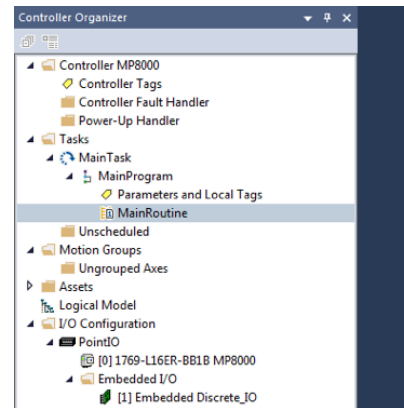

47. Above the "Main Routine" tab, use the "right arrow" to scroll until you see "File/Misc.," then click on "CPS"

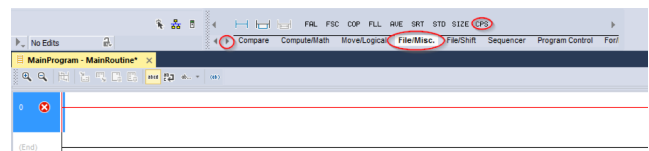

48. The CPS instruction will appear in the first rung of the Main Routine ladder logic

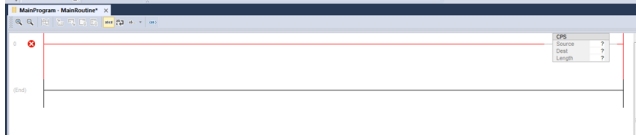

49. Double-clicking the "?" next to "Source" will allow you to tell the routine where the data is coming from

- In the case of REAL TIME data, the source should always be pointed at {MODULENAME:I1.Data[0]}

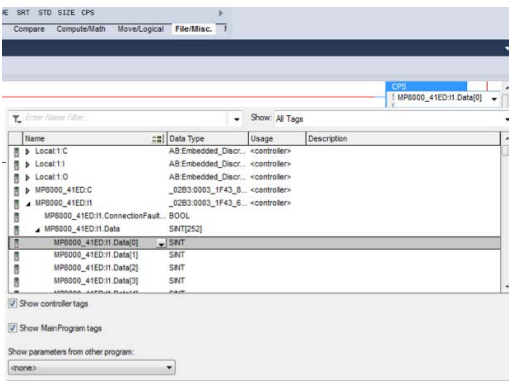

50. Double-clicking the "?" next to "Dest" will allow you to tell the routine where the data will be parsed to

- This will be the Controller Tag created in steps 41-45

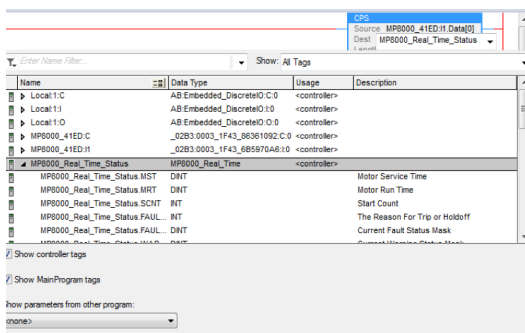

51. Single click the "?" next to "Length" and type a 1 in the box

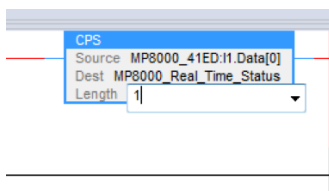

52. In the main tool bar, open COMMUNICATIONS -> "Who Active"

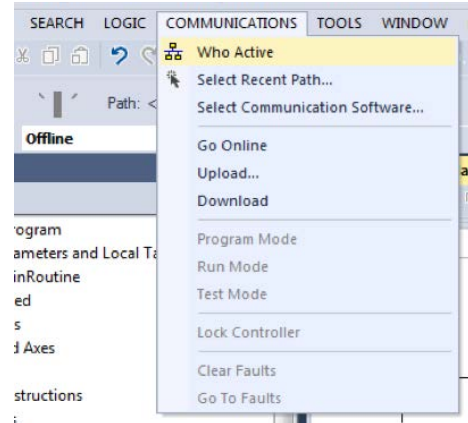

53. The "Who Active" window will open

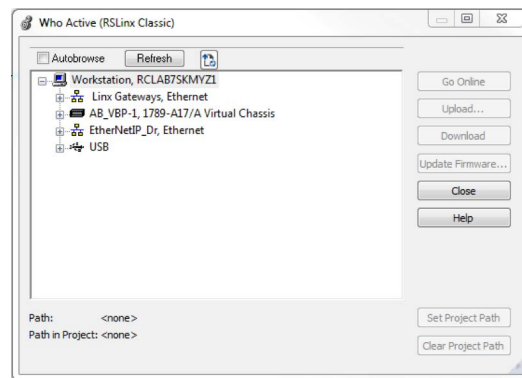

54. As all of our communications in the lab setting are done via the USB connection, expand the "USB" selection in the "Who Active" window

55. Highlight the entry for the connected PLC

56. Click on the "Download" button

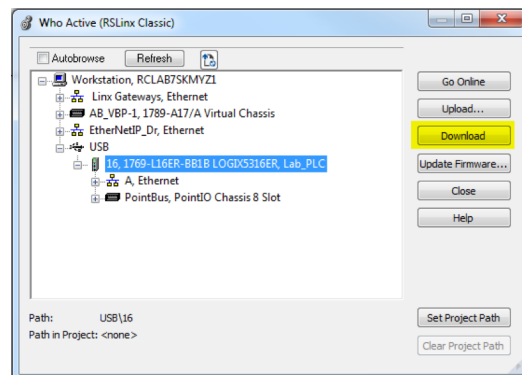

57. The “Download” window will appear, click the “Download” button

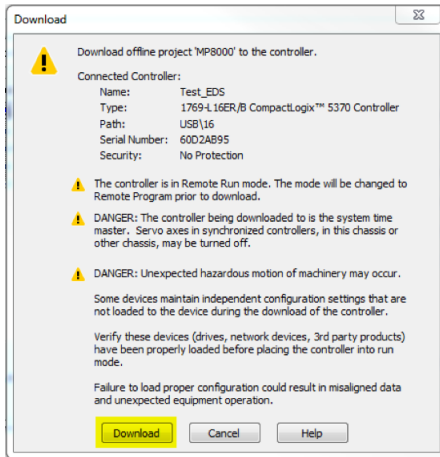

**For programming functions or commands see MP8000 Programming Guide**

## 9. APPENDIX A

### *AUX Relay Operations*

#### 9.1 Summary of Operations

There are three modes of operation for the AUX relay and each will be in this priority. 5000 environment

1. Ground Fault Alarm Mode
2. Network Control Mode
3. Alarm Indication Mode

If the customer selects option 3. Alarm Indication Mode, then they must also decide if they want it to be in

1. Fail safe (FS)
2. not-Fail Safe (NFS) (default)

They can also decide if the AUX Alarm relay will work with:

1. Hold Off conditions (default off)
2. Fault Conditions. (default off)

#### 9.2 Use Case Examples

##### **Factory Default**

By default, all AUX indications will be disabled. The GF detection is disabled, there is no network control and the AUX Alarm Indication is disabled.

##### **Events**

1. Control Power is applied
2. AUX relay is set in relaxed state.
3. No changes to AUX should be expected

##### **Ground Fault Alarm**

If the customer requires the Ground Fault Alarm operation, the following settings should be made:

- a. Set a Ground Fault current level. (default is zero)
- b. Disable the Motor Trip on Ground Fault (this change is needed as the default is the Motor relay fault will be generated by a ground fault condition).
- c. Note: if the Network control or the AUX Alarm Modes selections are set, they will be ignored by the firmware.

**Events**

1. Control Power is applied
2. AUX relay is set in the relaxed state.
3. MP8000 will operate as per the configuration settings.
  - a. If a Ground Fault trigger is detected
    - i. The AUX relay will be energized.
  - b. If no Ground Fault is detected
    - i. The AUX relay will be relaxed.

**Network Control**

If the customer requires the Network to control the AUX Relay, the following settings should be made:

- a. Set the Motor Trip on Ground Fault (GFMT) checkbox (default is ON)
- b. Setting the Network control can only be enabled via network commands.
- c. Note: the AUX Alarm Modes selections if set, they will be ignored by the firmware.

**Events**

1. Control Power is applied
2. The AUX relay will be initialized in the Relaxed state.
3. The MP8000 will operate as per the configuration settings.
4. The Network must send commands to change the state of the AUX Relay.

**AUX Alarm Relay Operations for Both Hold-off and Faults not fail safe**

If the customer requires AUX Alarm Relay operations the following settings should be made:

- a. Set the Motor Trip on Ground Fault (GFMT) checkbox. (default is ON)
- b. Set Indicate Holdoff (AIH) checkbox. (default is OFF)
- c. Set Indicated Fault (AIF) checkbox. (default is OFF)

**Events**

1. Control Power is applied
2. The AUX relay will be initialized in the Relaxed state.
3. The MP8000 will operate as per the configuration settings.

4. During the times that the Motor is not operating:
  - a. If a voltage hold-off condition is detected
    - i. The AUX relay will be energized.
  - b. If no voltage hold-off condition is detected
    - i. The AUX relay will be relaxed.
5. During the times that the Motor is operating:
  - a. If the motor is operating
    - i. The AUX relay will be relaxed
  - b. If a fault is detected
    - i. The AUX relay will be energized.

**AUX Alarm Relay Operations for Both Hold-off and Faults in fail safe**

If the customer requires AUX Alarm Relay operations the following settings should be made:

- a. Set the Motor Trip on Ground Fault (GFMT) checkbox. (default is ON)
- b. Set Indicate Holdoff (AIH) checkbox (default is OFF)
- c. Set Indicated Fault (AIF) checkbox (default is OFF).

**Events**

1. Control Power is applied
2. The AUX relay will be initialized in the Energized state.
3. The MP8000 will operate as per the configuration settings.
4. During the times that the Motor is not operating:
  - a. If a voltage hold-off condition is detected
    - i. The AUX relay will be relaxed.
  - b. If no voltage hold-off condition is detected
    - i. The AUX relay will be energized.
5. During the times that the Motor is operating:
  - a. If the motor is operating
    - i. The AUX relay will be energized
  - b. If a fault is detected
    - i. The AUX relay will be relaxed.