

# LTKAK6 Series

## SMT0-218 - 6KA



### Agency Approvals

Agency	Agency File Number
	E128662

### Maximum Ratings and Thermal Characteristics

( $T_A = 25^\circ\text{C}$  unless otherwise noted)

Parameter	Symbol	Value	Unit
Operating Junction	$T_J$	-55 to 125	°C
Storage Temperature Range	$T_{STG}$	-55 to 150	
Current Rating <sup>1</sup>	$I_{PP}$	6	kA
Typical Thermal Resistance Junction to Lead	$R_{\theta JL}$	10	°C/W
Typical Thermal Resistance Junction to Ambient	$R_{\theta JA}$	50	°C/W

**Note:**

1. Rated min  $I_{PP}$  measured with 8/20 $\mu\text{s}$  pulse.

### Description

The LTKAK6 series offers superior clamping characteristics over standard S.A.D. technologies by virtue of the Littelfuse Foldbak™ technology, which provides a clamping voltage lower than the avalanche voltage (but above the rated working voltage). Therefore, any voltage rise due to increased current conduction is contained to a minimum, providing the best possible protection level. This LTKAK6 series can be combined in series or parallel solutions to offer various clamping levels and surge withstand options.

The LTKAK6 SMT package provides a more compact PCB layout than typical through-hole AK TVS components.

### Features

- High Power TVS designed in a surface mount and compact SMT0-218 package
- Patent pending package design
- Foldbak™ Technology for superior clamping characteristics
- Tube or tape and reel pack options available
- Ideal for automatic pick and place assembly and reflow process to reduce the manufacturing cost and increase the soldering quality as compared to axial leaded packages
- Low clamping and slope resistance.
- Sharp breakdown voltage.
- Meet MSL level1, per J-STD-020, LF maximum peak of 245°C
- Pb-free E3 means 2nd level interconnect is Pb-free and the terminal finish material is tin(Sn) (IPC/JEDEC J-STD-609A.01)
- UL Recognized compound meeting flammability rating V-0

### Functional Diagram



Bi-directional

### Electrical Characteristics ( $T_A = 25^\circ\text{C}$ unless otherwise noted)

Part Numbers	Standoff Voltage ( $V_{SO}$ ) (V)	Max. Reverse Leakage ( $I_R$ ) @ $V_{SO}$ ( $\mu\text{A}$ )	Reverse Breakdown Voltage ( $V_{BR}$ ) @ $I_T$		Test Current $I_T$ (mA)	Max. Clamping Voltage $V_C$ @ ( $I_{PP}$ ) (Volts)	Max. Temp Coefficient of $V_{BR}$ (%/°C)	Max. Capacitance 0V Bias 10kHz (nF)
			Min Volts	Max Volts				
LTKAK6-058C	58	10	64	70	10	110	0.1	6.5
LTKAK6-066C	66	10	72	80	10	120	0.1	5.5
LTKAK6-076C	76	10	85	95	10	140	0.1	4.5

Note: Using 8/20 waveshape as defined in IEC 61000-4-5 2<sup>nd</sup> edition.

### Surge Ratings

Part Numbers	Max Peak Pulse Current ( $I_{PP}$ )			
	(80/20 $\mu\text{s}$ ) (A)	(10/350 $\mu\text{s}$ ) (A)		(10/1000 $\mu\text{s}$ ) (A)
	Min	Min	Typ	Min
LTKAK6-058C	6,000	900	1,100	430
LTKAK6-066C	6,000	900	1,100	430
LTKAK6-076C	6,000	900	1,100	430

# LTKAK6 Series

## SMT0-218 - 6KA

### I-V Curve Characteristics

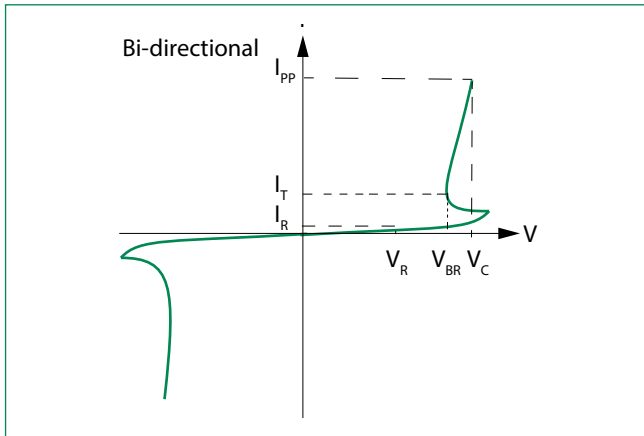

**P<sub>PPM</sub> Peak Pulse Power Dissipation --**

Max power dissipation

**V<sub>R</sub> Stand-off Voltage --**

Maximum voltage that can be applied to the TVS without operation

**V<sub>BR</sub> Breakdown Voltage --**

Maximum voltage that flows through the TVS at a specified test current (I<sub>T</sub>)

**V<sub>C</sub> Clamping Voltage --**

Peak voltage measured across the TVS at a specified I<sub>ppm</sub> (peak impulse current)

**I<sub>R</sub> Reverse Leakage Current --**

Current measured at V<sub>R</sub>

### Ratings and Characteristic Curves (T<sub>A</sub>=25°C unless otherwise noted)

#### Typical Peak Pulse Power Rating Curve

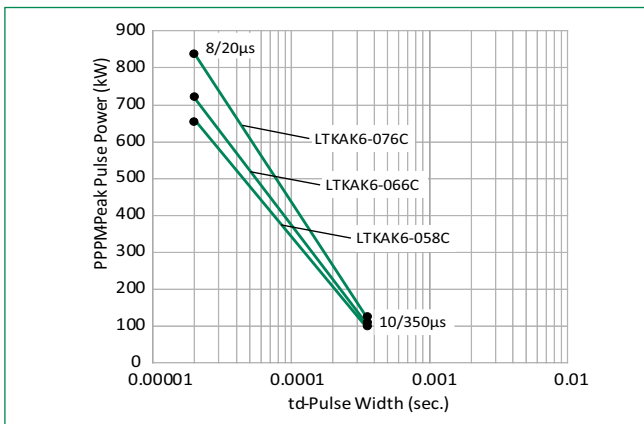

#### Peak Power Derating

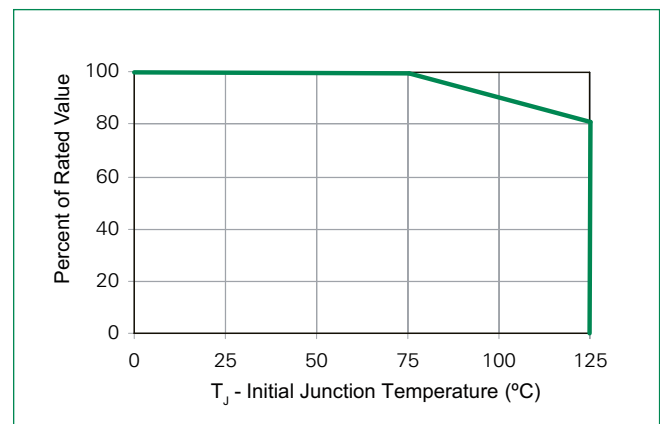

Please contact Littelfuse for reliability or FIT/MTBF data, the performance is subject to vary and depends on the end customers' application condition.

#### Pulse Waveform

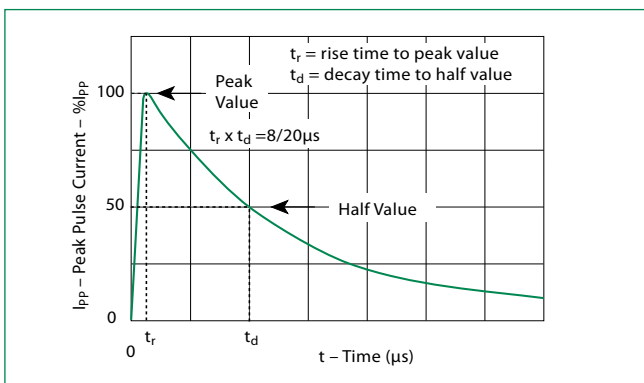

# LTKAK6 Series

## SMT0-218 - 6KA

### Soldering Parameters

<b>Reflow Condition</b>		Lead-free assembly
<b>Pre Heat</b>	- Temperature Min ( $T_{s(min)}$ )	150°C
	- Temperature Max ( $T_{s(max)}$ )	200°C
	- Time (min to max) ( $t_p$ )	60 – 180 secs
<b>Average ramp up rate (Liquidus Temp (<math>T_A</math>) to peak</b>		3°C/second max
<b><math>T_{s(max)}</math> to <math>T_A</math> - Ramp-up Rate</b>		3°C/second max
<b>Reflow</b>	- Temperature ( $T_A$ ) (Liquidus)	217°C
	- Time (min to max) ( $t_p$ )	60 – 150 seconds
<b>Peak Temperature (<math>T_p</math>)</b>		245 <sup>+0/-5</sup> °C
<b>Time within 5°C of actual peak Temperature (<math>t_p</math>)</b>		30 seconds Max
<b>Ramp-down Rate</b>		6°C/second max
<b>Time 25°C to peak Temperature (<math>T_p</math>)</b>		8 minutes Max.
<b>Do not exceed</b>		245°C

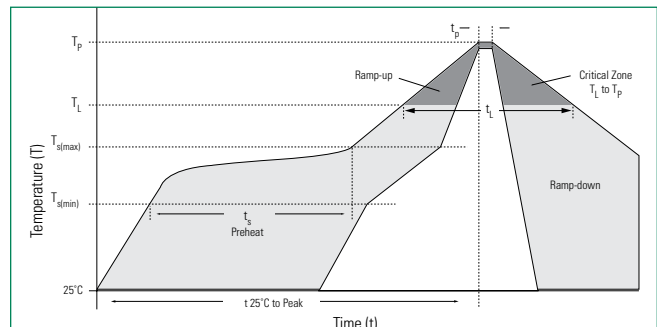

### Flow/Wave Soldering (Solder Dipping)

<b>Peak Temperature :</b>	260°C
<b>Dipping Time :</b>	10 seconds
<b>Soldering :</b>	1 time

### Physical Specifications

<b>Weight</b>	Contact manufacturer
<b>Case</b>	Epoxy encapsulated
<b>Terminal</b>	Tin plated lead, solderable per MIL-STD-202 Method 208

### Physical Specifications

<b>High Temp Storage</b>	JESD22-A103
<b>HTRB</b>	JESD22-A108
<b>MSL</b>	JESDEC-J-STD020, Level 1
<b>H3TRB</b>	JESD22-A101
<b>RSH</b>	JESD22-B106

### Part Numbering System

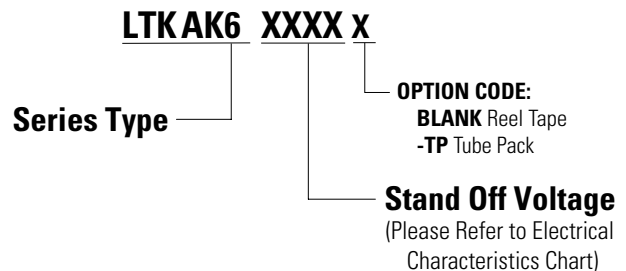

### Part Marking System

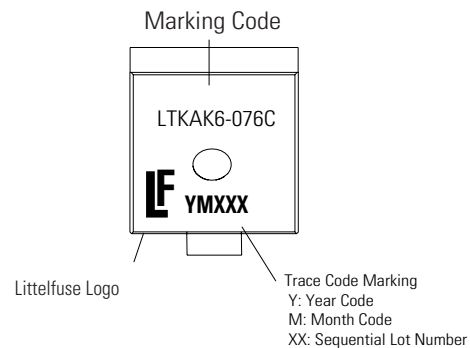

# LTKAK6 Series

## SMT0-218 - 6KA

### Dimensions – SMT0-218

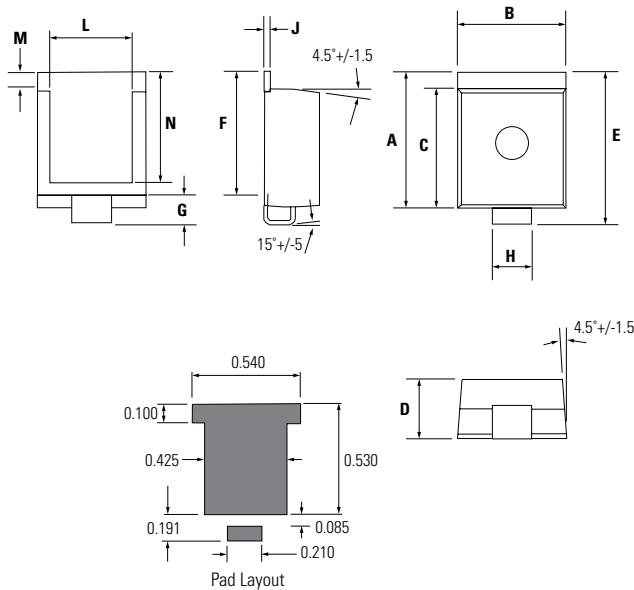

Dimension	Inches		Millimeters	
	Min	Max	Min	Max
<b>A</b>	0.621	0.655	15.78	16.63
<b>B</b>	0.529	0.594	13.43	15.09
<b>C</b>	0.544	0.561	13.83	14.24
<b>D</b>	0.273	0.285	6.94	7.24
<b>E</b>	0.702	0.737	17.82	18.72
<b>F</b>	0.567	0.587	14.40	14.90
<b>G</b>	0.087	0.126	2.20	3.20
<b>H</b>	0.193	0.222	4.89	5.65
<b>J</b>	0.028	0.033	0.72	0.85
<b>L</b>	0.400	0.440	10.17	11.17
<b>M</b>	0.073	0.112	1.85	2.85
<b>N</b>	0.510	0.533	12.95	13.55

### Packaging

Part Number	Weight	Packing Mode	Base Quantity
LTKAK6-xxxC	4.34g	Tape & Reel – 32mm/13" tape	400
LTKAK6-xxxC-TP	4.34g	Tube Pack	100(25/Tube)

### Tape and Reel Specification

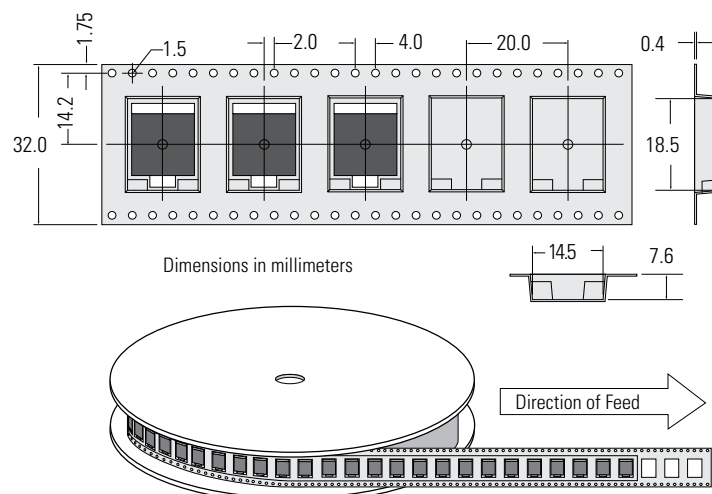

**Disclaimer Notice** - Information furnished is believed to be accurate and reliable. However, users should independently evaluate the suitability of and test each product selected for their own applications. Littelfuse products are not designed for, and may not be used in, all applications. Read complete Disclaimer Notice at [www.littelfuse.com/disclaimer-electronics](http://www.littelfuse.com/disclaimer-electronics).