

LQ05041RCS6

5 V, 4 A Ultra Low Consumption Load Switch With Reverse Current Blocking



Description

The LQ05041RCS6 represents a cutting-edge, fully integrated high-efficiency load switch device equipped with Reverse Current Blocking (RCB) technology and output voltage slew rate control.

With its leading Reverse Current Blocking (RCB) performance and ultra-low threshold voltage, the LQ05041RCS6 prevents reverse current when V_{OUT} exceeds V_{IN} voltage.

The LQ05041RCS6 offers a typical $14\text{ m}\Omega$ R_{ON} at 5.5 V , minimizing power loss during operation. Furthermore, it offers a ultra-low shutdown current (I_{SD}) to curtail power wastage and battery drain when in the off state. If EN is pulled low and the output is grounded, the LQ05041RCS6 can achieve a typical I_{SD} as low as 56 nA at 5.5 V .

The LQ05041RCS6 load switch device is designed in a chip scale package of $0.97\text{ mm} \times 1.47\text{ mm} \times 0.55\text{ mm}$ with 6 bumps and 0.5 mm pitch and support an extensive input voltage range, enhancing both the operational lifespan and the resilience of your system. Additionally, this single device can serve in various voltage rail applications, streamlining inventory management and lowering operational expenses.

Pinout Designation

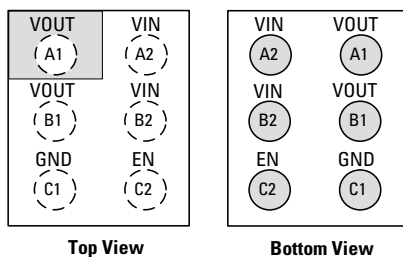

0.97 mm x 1.47 mm x 0.55 mm WLCSP

Pin Description

Pin #	Pin Name	Description
A1,B1	V_{OUT}	Switch output
A2,B2	V_{IN}	Switch input. Supply voltage
C1	GND	Ground
C2	EN	Enable to control the switch

Features and Benefits

- Reverse current blocking
- Low R_{ON} : $14\text{ m}\Omega$ typ at 5.5 V_{IN}
- Ultra-low I_{O} : $1.3\text{ }\mu\text{A}$ typ at 5.5 V_{IN}
- Ultra-low I_{SD} : 56 nA typ at 5.5 V_{IN}
- I_{OUT} max: 4 A
- Supply voltage range: 1.5 V to 5.5 V , 6 Vabs max
- Controlled V_{OUT} rise time $730\text{ }\mu\text{s}$ at 3.3 V_{IN}
- Internal EN pull-down resistor
- Ultra-small: 6 bumps in a $0.97\text{ mm} \times 1.47\text{ mm} \times 0.55\text{ mm}$ WLCSP

Applications

- Mobile devices
- Wearables
- IoT devices
- Low power subsystems

LQ05041RCS6

5 V, 4 A Ultra Low Consumption Load Switch With Reverse Current Blocking

Functional Block Diagram

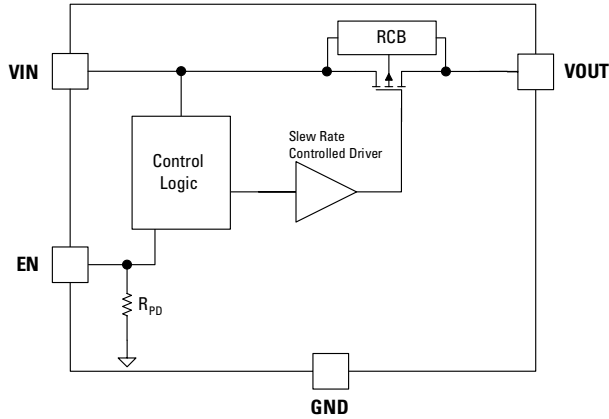

Typical Applications

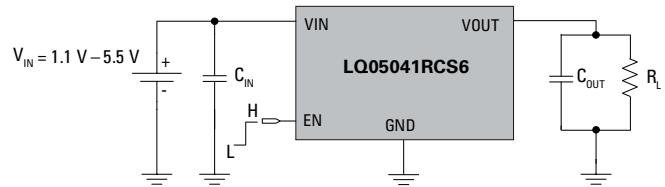

Absolute Maximum Rating

Symbol	Parameter	Min	Max	Unit
V_{IN}, V_{OUT}, V_{EN}	Each Pin Voltage Range to GND	-0.3	6	V
I_{OUT}	Maximum Continuous Switch Current		4	A
P_D	Power Dissipation at $T_A = 25\text{ }^\circ\text{C}$		1.2	W
T_{STG}	Storage Junction Temperature	-65	150	$^\circ\text{C}$
T_J	Maximum Junction Temperature		150	$^\circ\text{C}$
θ_{JA}	Thermal Resistance, Junction to Ambient (Measured using 2S2P JEDEC std. PCB.)		85	$^\circ\text{C/W}$
ESD	Electrostatic Discharge Capability	Human Body Model, JESD22-A114	6	kV
		Charged Device Model, JESD22-C101	2	kV

Note: Stresses exceeding the absolute maximum ratings may damage the device. The device may not function or be operable above the recommended operating conditions; extended exposure to stresses above the recommended operating conditions may affect device reliability. The absolute maximum ratings are stress ratings only.

Recommend Operating Conditions

Symbol	Parameter	Min	Max	Unit
V_{IN}	Supply Voltage	1.5	5.5	V
T_A	Ambient Operating Temperature	-40	85	$^\circ\text{C}$

Note: The device is not guaranteed to function outside of the recommended operating conditions.

LQ05041RCS6

5 V, 4 A Ultra Low Consumption Load Switch With Reverse Current Blocking

Electrical Characteristics (Values are at $V_{IN} = 3.3\text{ V}$ and $T_A = 25\text{ °C}$ unless otherwise noted.)

Symbol	Parameter	Test Conditions	Min	Typ	Max	Unit	
Basic Operation							
I_Q	Supply Current	EN = Enable, $I_{OUT} = 0\text{ mA}$, $V_{IN} = V_{EN} = 5.5\text{ V}$		1.9		μA	
		EN = Enable, $I_{OUT} = 0\text{ mA}$, $V_{IN} = V_{EN} = 5.5\text{ V}^1$	1.3	1.85	5.5	μA	
		EN = Enable, $I_{OUT} = 0\text{ mA}$, $V_{IN} = V_{EN} = 5.5\text{ V}$, $T_A = 85\text{ °C}^{1,3}$	1.4			μA	
I_{SD}	Shutdown Current	EN = Disable, $I_{OUT} = 0\text{ mA}$, $V_{IN} = 1.5\text{ V}$		5	20	nA	
		EN = Disable, $I_{OUT} = 0\text{ mA}$, $V_{IN} = 3.3\text{ V}$		8		nA	
		EN = Disable, $I_{OUT} = 0\text{ mA}$, $V_{IN} = 4.2\text{ V}$		12		nA	
		EN = Disable, $I_{OUT} = 0\text{ mA}$, $V_{IN} = 5.5\text{ V}$		56	100	nA	
		EN = Disable, $I_{OUT} = 0\text{ mA}$, $V_{IN} = 5.5\text{ V}$, $T_A = 85\text{ °C}^3$		1000		nA	
R_{ON}	On-Resistance	$V_{IN} = 5.5\text{ V}$, $I_{OUT} = 500\text{ mA}$	$T_A = 25\text{ °C}$	14	19	$\text{m}\Omega$	
			$T_A = 85\text{ °C}^3$		16		$\text{m}\Omega$
		$V_{IN} = 3.3\text{ V}$, $I_{OUT} = 500\text{ mA}$	$T_A = 25\text{ °C}$	18	23	$\text{m}\Omega$	
			$T_A = 85\text{ °C}^3$		21		$\text{m}\Omega$
		$V_{IN} = 1.8\text{ V}$, $I_{OUT} = 300\text{ mA}$	$T_A = 25\text{ °C}$		30		$\text{m}\Omega$
		$V_{IN} = 1.5\text{ V}$, $I_{OUT} = 100\text{ mA}$	$T_A = 25\text{ °C}$		37	42	$\text{m}\Omega$
V_{IH}	EN Input Logic High Voltage	$V_{IN} = 1.5 - 5.5\text{ V}$	1.2			V	
V_{IL}	EN Input Logic Low Voltage	$V_{IN} = 1.5 - 5.5\text{ V}$			0.4	V	
R_{EN}	EN pull down resistance	Internal Resistance		10		$\text{M}\Omega$	
I_{EN}	EN Source or Sink Current	$V_{EN} = V_{IN}$ or GND		0.5	1	μA	
V_{RCB_TH}	RCB Protection Threshold Voltage	$V_{OUT} - V_{IN}$		37		mV	
V_{RCB_RL}	RCB Protection Release Voltage	$V_{IN} - V_{OUT}$		37		mV	
I_{RCB_TH}	RCB Protection Threshold Current	$V_{IN} = 3.3\text{ V}$, Enabled, $V_{OUT} > V_{IN}$		1.7		A	
$t_{Trigger}$	RCB Trigger Time	$V_{IN} = 3.3\text{ V}$, Enabled, $V_{OUT} > V_{IN} + 37\text{ mV}$		18.3		μs	
Switching Characteristics²							
t_{dON}	Turn-On Delay	$R_{OUT} = 150\ \Omega$, $C_{OUT} = 0.1\ \mu\text{F}$		450		μs	
t_R	V_{OUT} Rise Time			730		μs	
t_{dOFF}	Turn-Off Delay ³	$R_{OUT} = 150\ \Omega$, $C_{OUT} = 0.1\ \mu\text{F}$		20		μs	
t_F	V_{OUT} Fall Time ³			360		μs	

Notes:

- I_Q does not include enable pull down current through the pull-down resistor RPD.
- $t_{dON} = t_{dON} + t_R$, $t_{dOFF} = t_{dOFF} + t_F$
- By design, characterized, not production tested.

LQ05041RCS6

5 V, 4 A Ultra Low Consumption Load Switch With Reverse Current Blocking

Timing Waveforms

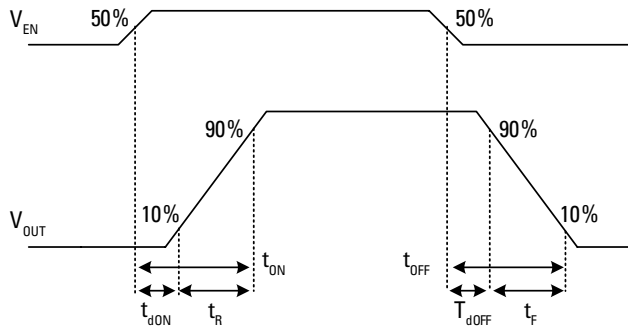

Typical Performance Characteristics

Figure 1 - On-Resistance vs. Supply Voltage

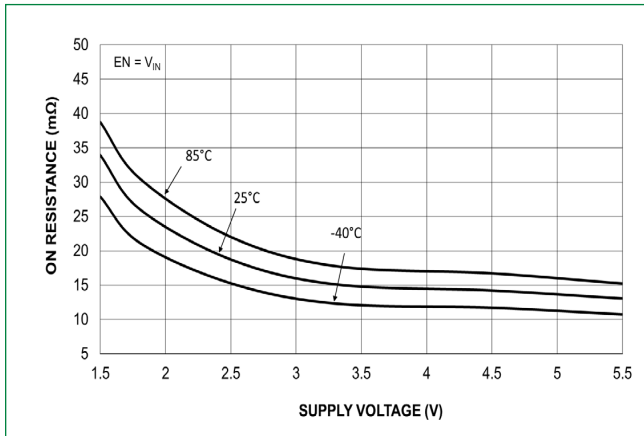

Figure 2 - On-Resistance vs. Temperature

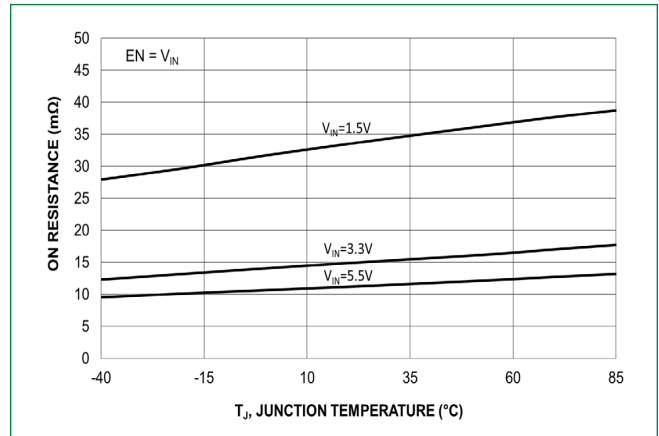

Figure 3 - Quiescent Current vs. Supply Voltage

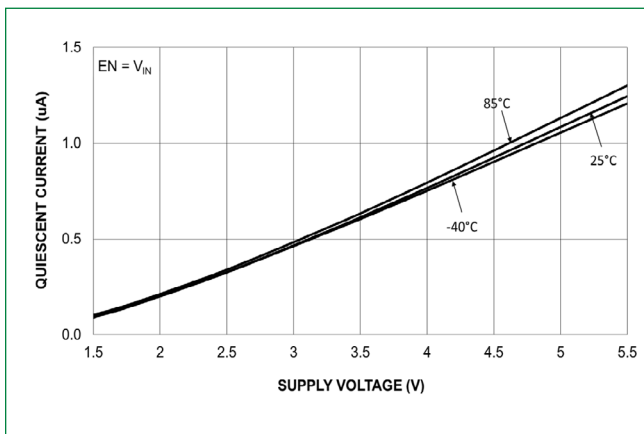
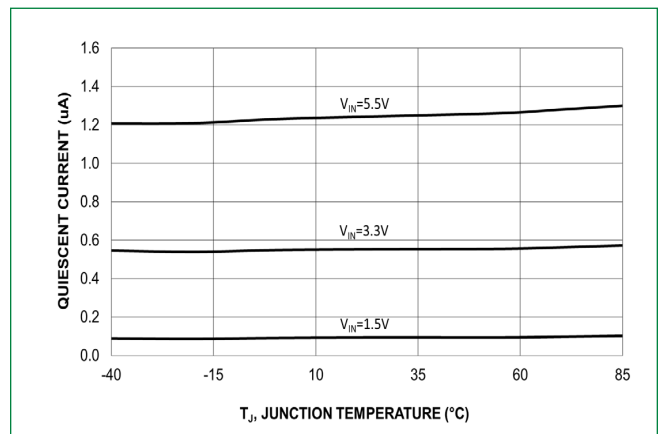

Figure 4 - Quiescent Current vs. Temperature



LQ05041RCS6

5 V, 4 A Ultra Low Consumption Load Switch With Reverse Current Blocking

Figure 5 - Shutdown Current vs. Supply Voltage

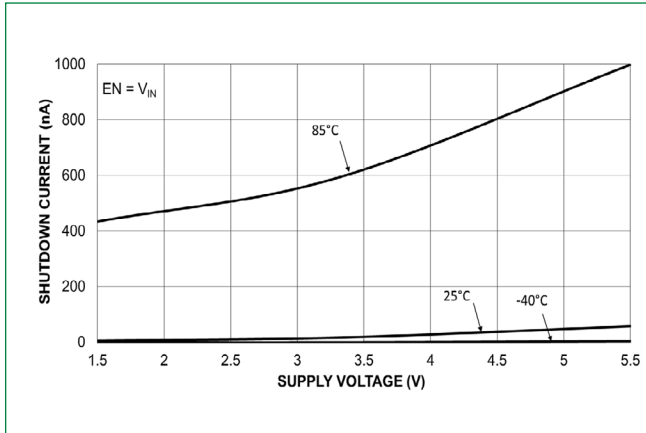

Figure 6 - Shutdown Current vs. Temperature

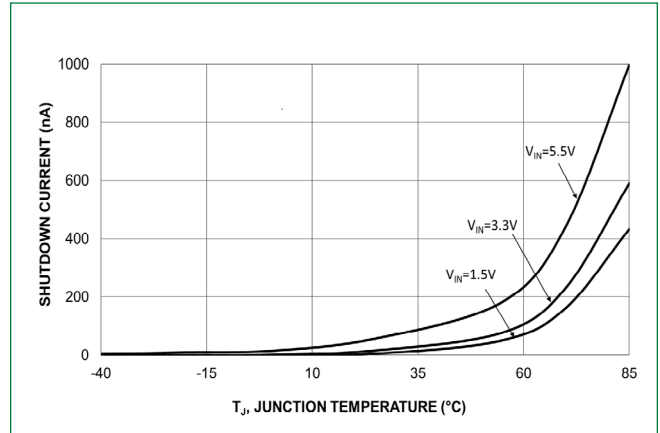

Figure 7 - EN Input Logic High Threshold

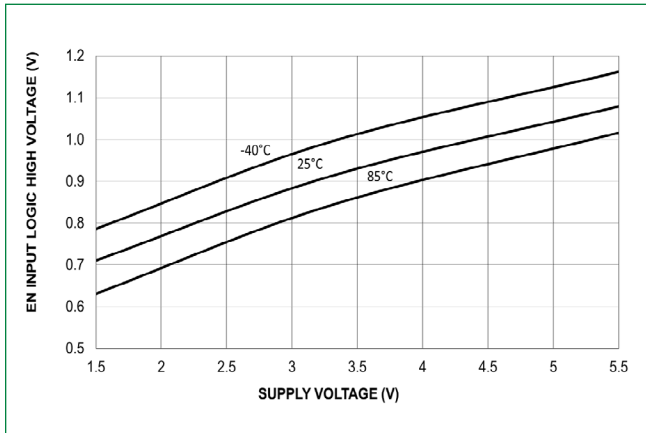

Figure 8 - EN Input Logic High Threshold Vs. Temperature

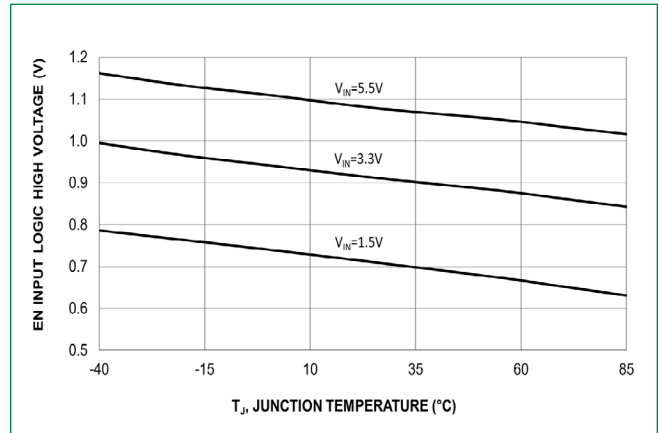

Figure 9 - EN Input Logic Low Threshold

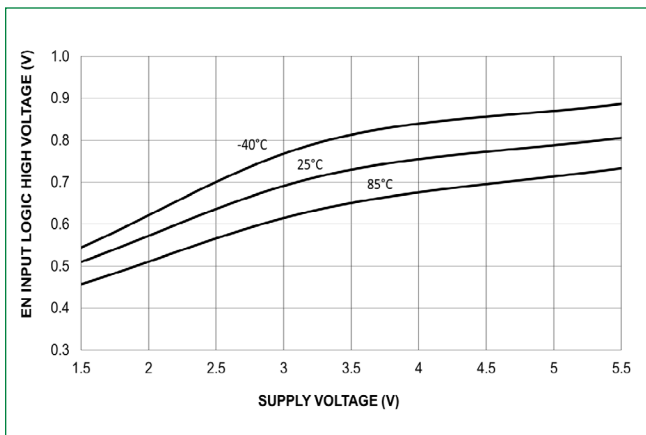
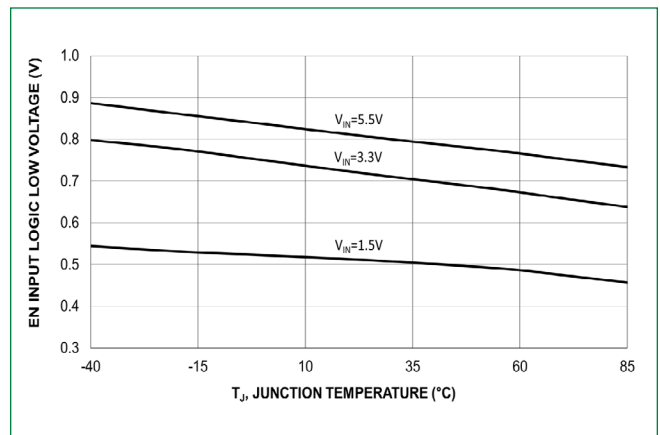

Figure 10 - EN Input Logic Low Threshold Vs. Temperature



LQ05041RCS6

5 V, 4 A Ultra Low Consumption Load Switch With Reverse Current Blocking

Figure 11 - V_{OUT} Rise Time vs. Temperature

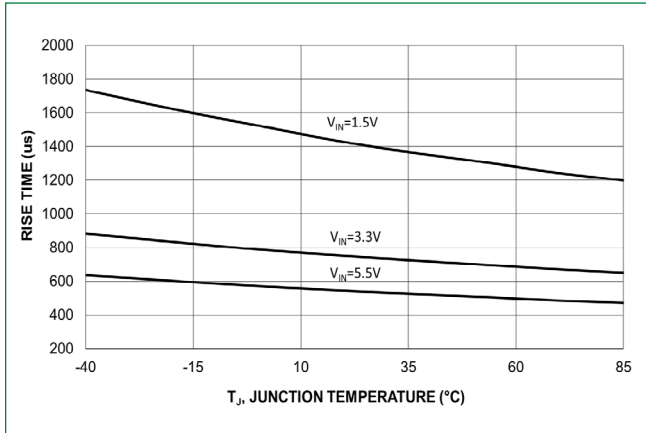

Figure 12 - Turn-On Delay Time vs. Temperature

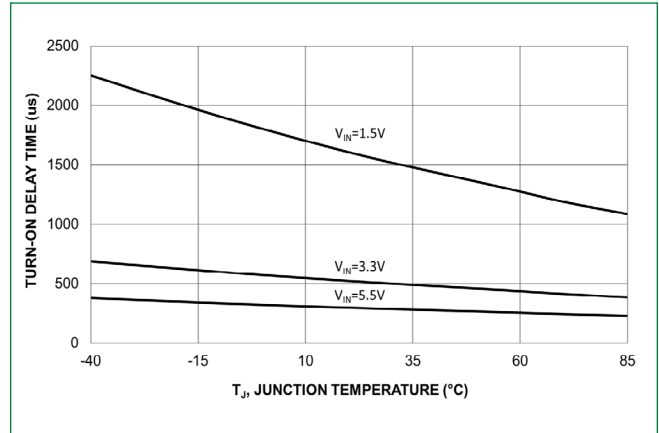

Figure 13 - Turn-On Response
 $V_{IN} = 3.3V$, $C_{IN} = 1.0\ \mu F$, $C_{OUT} = 0.1\ \mu F$, $R_L = 150\ \Omega$

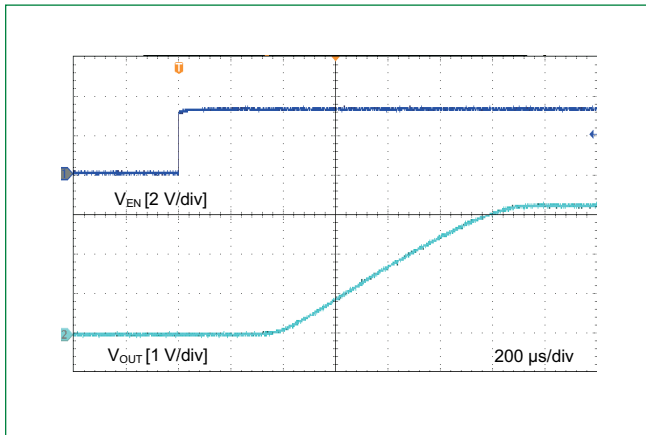

Figure 14 - Turn-On Response
 $V_{IN} = 3.3V$, $C_{IN} = 1.0\ \mu F$, $C_{OUT} = 0.1\ \mu F$, $R_L = 500\ \Omega$

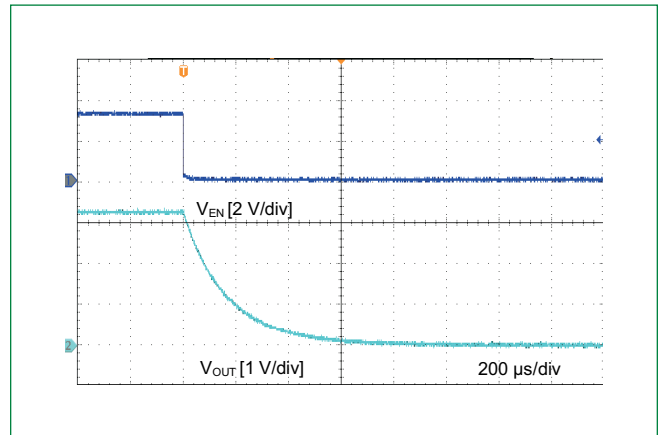
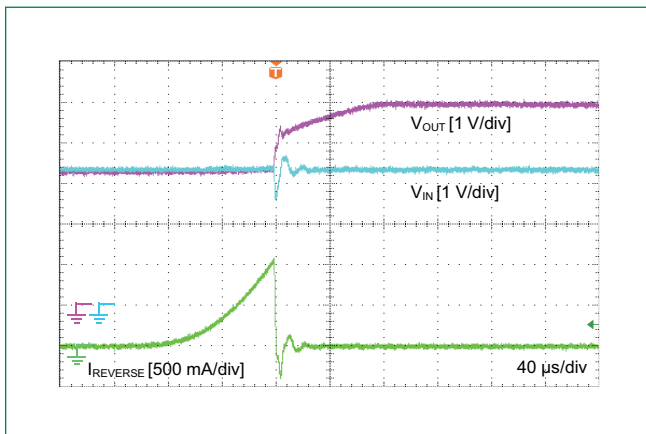

Figure 15 - Reverse Current Blocking at Switch On
 $V_{IN} = \text{Open}$, $C_{IN} = 1.0\ \mu F$, $C_{OUT} = 0.1\ \mu F$



LQ05041RCS6

5 V, 4 A Ultra Low Consumption Load Switch With Reverse Current Blocking

Application Information

The LQ05041RCS6 is a highly efficient integrated load switch with a 4 A capacity. It allows slew rate control of the output voltage to limit inrush current when activated. This device works with a wide input voltage range, from 1.5 V to 5.5 V, and has minimal on-resistance to reduce power loss. When it is off, it has very low leakage current, saving power resources. It is in a chip scale size package at 0.97 mm x 1.47 mm x 0.55 mm with 6 bumps at a 0.5 mm pitch make it ideal for efficient manufacturing in the space-saving required applications.

Input Capacitor

The proper functioning of the LQ05041RCS6 needs the presence of an input capacitor. Consider using a 1 μF capacitor positioned near the V_{IN} pin to address voltage fluctuations on the input power rail that may occur as a result of transient inrush current during startup. To reduce the extent of the input voltage drop, suggest to use a higher input capacitor value.

Output Capacitor

A capacitor with a value of 0.1 μF or higher is capable of preventing undershoot caused by parasitic inductance in onboard traces when the circuit is powered off, thus enhancing the reliability of a regulated voltage supply. The C_{OUT} should be positioned in close position to the V_{OUT} and GND pins.

The LQ05041RCS6 can be turned on by setting the EN pin to a high level. Be aware that there is an internal pull-down resistor in EN pin which can pull the primary switch to "off state" as long as no EN signal from an external controller is applied.

Reverse Current Blocking

The LQ05041RCS6 incorporates a built-in reverse current blocking protection feature that continuously monitors the output voltage level, irrespective of the status of the EN pin. Its purpose is to verify if the output voltage exceeds the input voltage.

When the output voltage surpasses the input voltage by 37 mV, known as the trip voltage for reverse current blocking protection, the function responsible for reverse current blocking deactivates the switch.

It's important to note that some reverse current may persist until the V_{RCB} is triggered.

The switch will return to normal operation when the output voltage falls below the input source by the RCB protection release voltage.

Board Layout

To minimize the impact of parasitic inductance, it is advisable to keep all traces as short as possible. Using wider traces for V_{IN} , V_{OUT} , and GND is recommended to mitigate parasitic effects during dynamic operations and enhance thermal efficiency under high load currents.

Dimensions

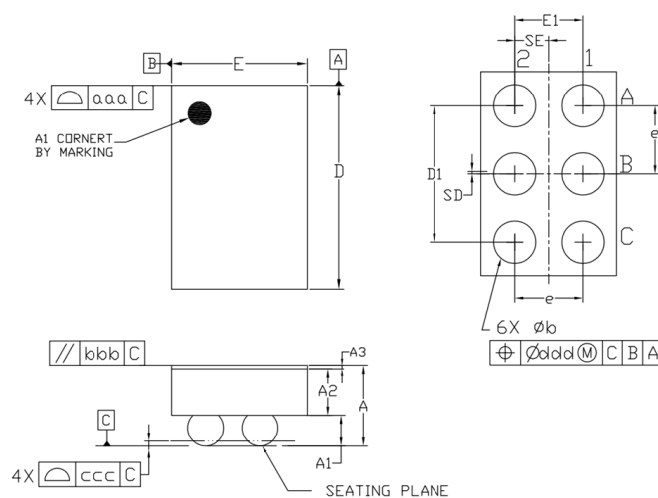

Dimension	Millimeters		
	Min	Nom	Max
A	0.500	0.550	0.600
A1	0.225	0.250	0.275
A2	0.250	0.275	0.300
A3	0.020	0.025	0.030
D	1.460	1.470	1.485
E	0.960	0.970	0.985
D1	0.950	1.000	1.050
E1	0.450	0.500	0.550
b	0.260	0.310	0.360
e	0.500 BSC		
SD	0.000 BSC		
SE	0.250 BSC		
Tol. of Form & Position			
aaa	0.100		
bbb	0.100		
ccc	0.050		
ddd	0.050		

LQ05041RCS6

5 V, 4 A Ultra Low Consumption Load Switch With Reverse Current Blocking

Part Numbering

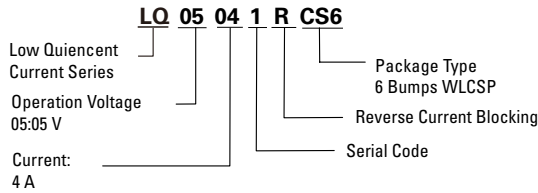

Part Marking

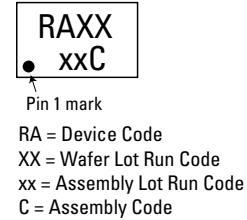

Carrier Tape & Reel Specification

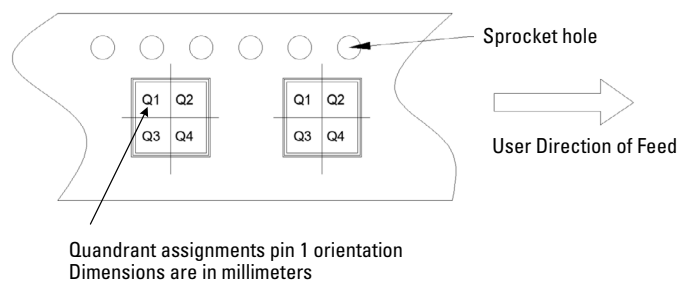
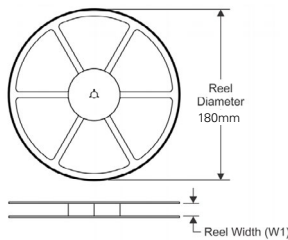
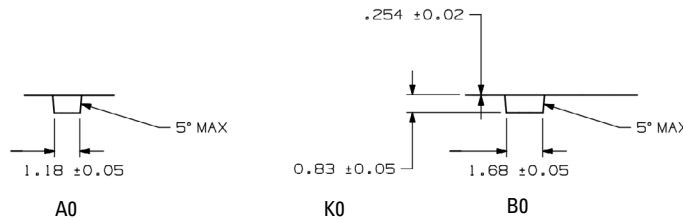
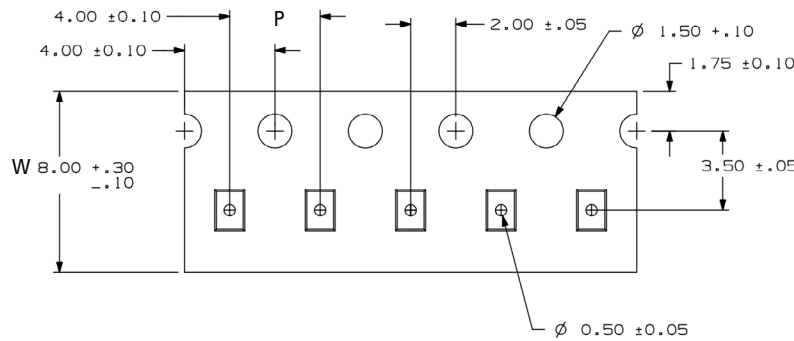

Device	Package	Pins	SPQ	Reel Diameter	Reel Width W1	A0	B0	K0	P	W	Pin1
LQ05041RCS6	6 Bumps WLCSP	6	3000	180	9	1.18	1.68	0.83	4	8	Q1

Product Disclaimer - Littelfuse products are not designed for, and shall not be used for, any purpose (including, without limitation, automotive, military, aerospace, medical, life-saving, life-sustaining or nuclear facility applications, devices intended for surgical implant into the body, or any other application in which the failure or lack of desired operation of the product may result in personal injury, death, or property damage) other than those expressly set forth in applicable Littelfuse product documentation. Warranties granted by Littelfuse shall be deemed void for products used for any purpose not expressly set forth in applicable Littelfuse documentation. Littelfuse shall not be liable for any claims or damages arising out of products used in applications not expressly intended by Littelfuse as set forth in applicable Littelfuse documentation. The sale and use of Littelfuse products is subject to Littelfuse Terms and Conditions of Sale, unless otherwise agreed by Littelfuse. "Littelfuse" includes Littelfuse, Inc., and all of its affiliate entities.

<https://www.littelfuse.com/legal/disclaimers/product-disclaimer.aspx>