

OT08PC  
RELAY SOCKET

EN550022 (35.0 x 7.5)  
DIN RAIL SHOWN

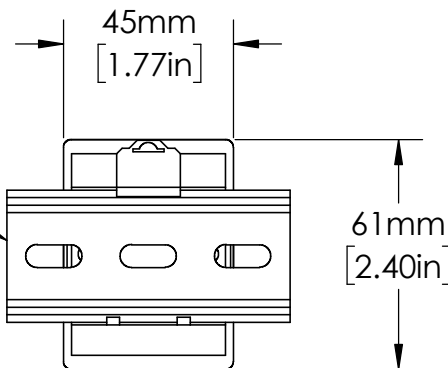

UNLESS NOTED OTHERWISE  
DIMENSIONS ARE IN INCHES  
TOLERANCES:  
TWO PLACE DECIMAL ±0.05  
NOT DRAWN TO SCALE

MATERIAL	
NAME	DATE
DRAWN BY J.MOLER	12/28/22



DESCRIPTION: PUMP AND LIQUID  
LEVEL CONTROL

PART NUMBER: LLC5 SERIES  
REV A

WEIGHT: SHEET 1 OF 1