

## SP6001 Series 12pF 30kV EMI Filter Array

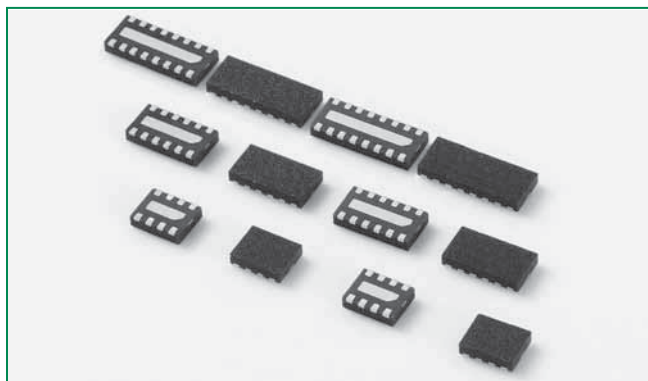

### Pinout

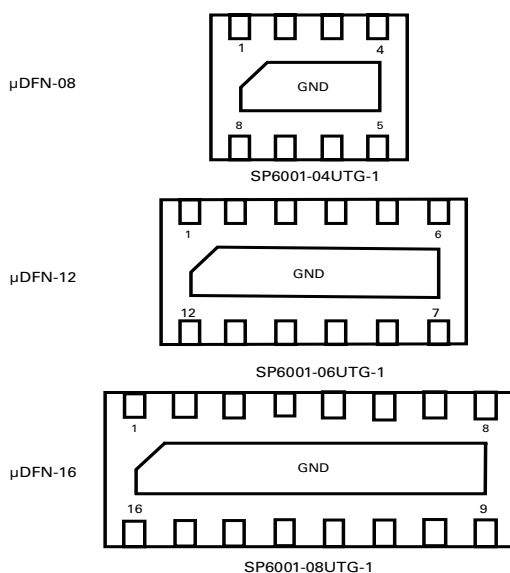

### Functional Block Diagram

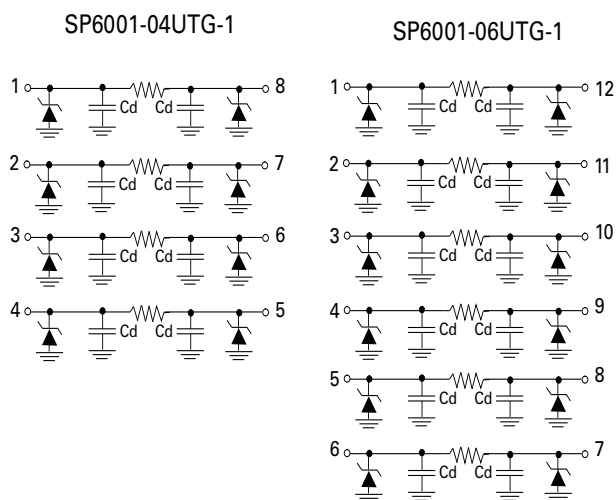

### Description

The Littelfuse SP6001 SPA series integrates 4, 6 and 8 EMI filters (C-R-C) into a small, low-profile μDFN package with each filter providing greater than -30dB attenuation at 1GHz. Additionally, each I/O is capable of shunting ±30kV ESD strikes (IEC61000-4-2, contact discharge) away from sensitive electronic components. The performance of this small, slim design makes it extremely suitable for mobile handsets, PDAs and notebook computers.

### Features

- EMI filtering of frequencies from 800MHz to 3GHz
- Greater than -30dB attenuation (TYP) at 1GHz
- ESD, IEC61000-4-2, ±30kV contact, ±30kV air
- Small, low-profile μDFN (JEDEC MO-229) package (TYP 0.5mm height)

### Applications

- Keypad interface for portable electronics
- LCD and camera display interfaces for handsets
- Connector interfaces for portable electronics
- Mobile phone
- Smartphone
- Portable navigation device

### Application Examples

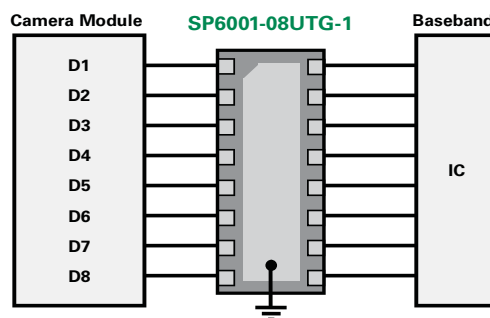
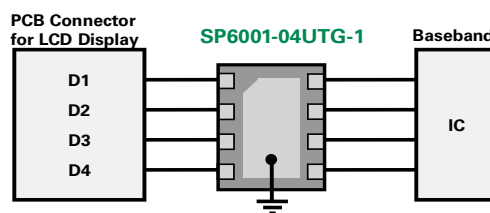

**Absolute Maximum Ratings**

| Symbol            | Parameter             | Value      | Units |
|-------------------|-----------------------|------------|-------|
| T <sub>OP</sub>   | Operating Temperature | -40 to 85  | °C    |
| T <sub>STOR</sub> | Storage Temperature   | -60 to 150 | °C    |

CAUTION: Stresses above those listed in "Absolute Maximum Ratings" may cause permanent damage to the device. This is a stress only rating and operation of the device at these or any other conditions above those indicated in the operational sections of this specification is not implied.

**Thermal Information**

| Parameter                                   | Rating     | Units |
|---------------------------------------------|------------|-------|
| Storage Temperature Range                   | -65 to 150 | °C    |
| Maximum Junction Temperature                | 150        | °C    |
| Maximum Lead Temperature (Soldering 20-40s) | 260        | °C    |

**Electrical Characteristics (T<sub>OP</sub>=25°C)**

| Parameter                          | Symbol            | Test Conditions                                      | Min           | Typ | Max            | Units |
|------------------------------------|-------------------|------------------------------------------------------|---------------|-----|----------------|-------|
| Reverse Standoff Voltage           | V <sub>RWM</sub>  |                                                      |               |     | 6.0            | V     |
| Breakdown Voltage                  | V <sub>BR</sub>   | I <sub>R</sub> =1mA                                  | 7.0 (90%TYP)  | 7.8 | 8.5 (109%TYP)  | V     |
| Reverse Leakage Current            | I <sub>LEAK</sub> | V <sub>RWM</sub> =5V                                 |               | 0.1 | 1.0            | µA    |
| Resistance                         | R <sub>A</sub>    | I <sub>R</sub> =10mA                                 | 85 (85%TYP)   | 100 | 115 (115% TYP) | Ω     |
| Diode Capacitance <sup>1,2</sup>   | C <sub>D</sub>    | V <sub>R</sub> =2.5V,f=1MHz                          |               | 12  |                | pF    |
| Line Capacitance <sup>1,2</sup>    | C <sub>L</sub>    | V <sub>R</sub> =2.5V,f=1MHz                          | 19 (79.2%TYP) | 24  | 29 (120.8%TYP) | pF    |
| ESD Withstand Voltage <sup>1</sup> | V <sub>ESD</sub>  | IEC61000-4-2 (Contact Discharge)                     | ±30           |     |                | kV    |
|                                    |                   | IEC61000-4-2 (Air Discharge)                         | ±30           |     |                | kV    |
| Cutoff Frequency <sup>3</sup>      | F <sub>-3dB</sub> | Above this frequency, appreciable attenuation occurs |               | 115 |                | MHz   |

Notes: <sup>1</sup> Parameter is guaranteed by design and/or device characterization.  
<sup>2</sup> Total line capacitance is two times the diode capacitance (C<sub>D</sub>).  
<sup>3</sup> 50Ω source and 50Ω load termination

**Insertion Loss (S21)**

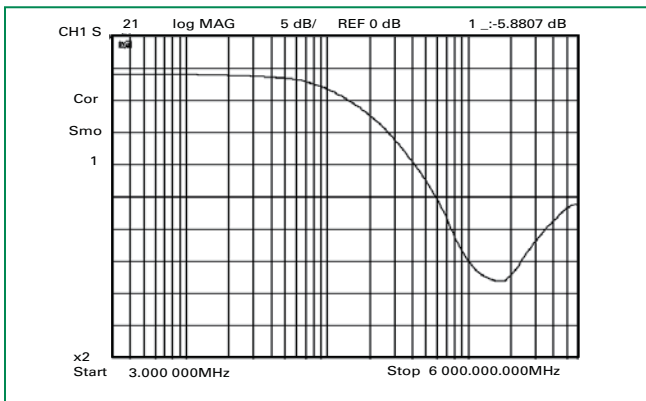

**Analog Crosstalk (S41)**

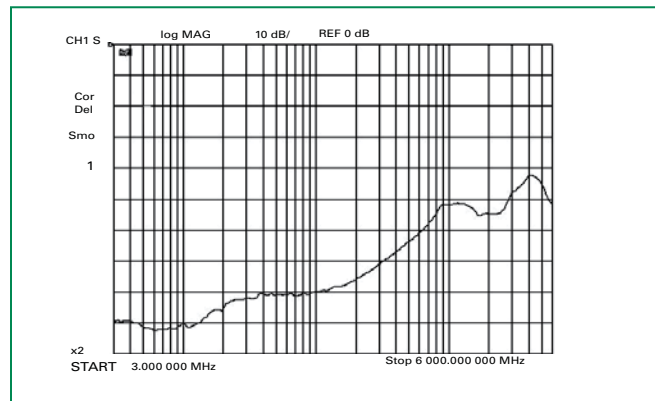

**Product Characteristics**

|                            |                         |
|----------------------------|-------------------------|
| <b>Lead Plating</b>        | Pre-Plated Frame        |
| <b>Lead Material</b>       | Copper Alloy            |
| <b>Lead Coplanarity</b>    | 0.0004 inches (0.102mm) |
| <b>Substitute Material</b> | Silicon                 |
| <b>Body Material</b>       | Molded Epoxy            |
| <b>Flammability</b>        | UL 94 V-0               |

Notes :  
1. All dimensions are in millimeters  
2. Dimensions include solder plating.  
3. Dimensions are exclusive of mold flash & metal burr.  
4. Blo is facing up for mold and facing down for trim/form, i.e. reverse trim/form.  
5. Package surface matte finish VDI 11-13.

**Line Capacitance vs. DC Bias**

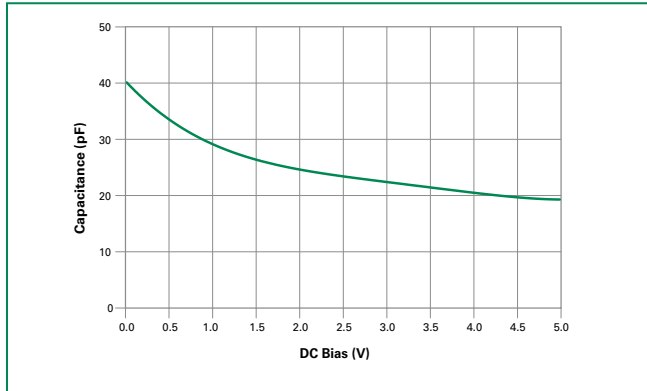

**Package Dimensions — μDFN-08**

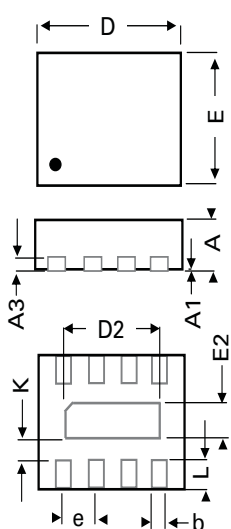

|           | μDFN-08      |       |           |       |
|-----------|--------------|-------|-----------|-------|
|           | JEDEC MO-229 |       |           |       |
|           | Millimeters  |       | Inches    |       |
|           | Min          | Max   | Min       | Max   |
| <b>A</b>  | 0.450        | 0.550 | 0.018     | 0.022 |
| <b>A1</b> | 0.000        | 0.050 | 0.000     | 0.002 |
| <b>A3</b> | 0.127 REF    |       | 0.005 REF |       |
| <b>b</b>  | 0.150        | 0.250 | 0.006     | 0.010 |
| <b>D</b>  | 1.600        | 1.800 | 0.063     | 0.071 |
| <b>D2</b> | 1.100        | 1.300 | 0.043     | 0.051 |
| <b>E</b>  | 1.250        | 1.450 | 0.049     | 0.057 |
| <b>E2</b> | 0.300        | 0.500 | 0.012     | 0.020 |
| <b>e</b>  | 0.400 BSC    |       | 0.016 BSC |       |
| <b>K</b>  | 0.200        |       | 0.008     | 0.000 |
| <b>L</b>  | 0.150        | 0.350 | 0.006     | 0.014 |

**Package Dimensions — μDFN-16**

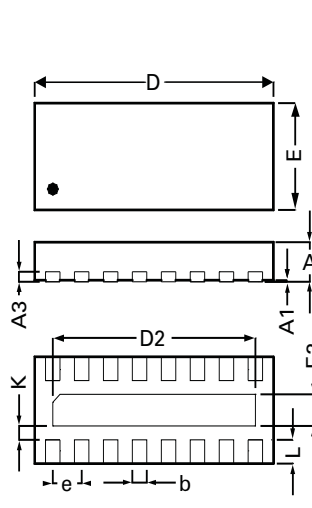

|           | μDFN-16      |      |          |       |
|-----------|--------------|------|----------|-------|
|           | JEDEC MO-229 |      |          |       |
|           | Millimeters  |      | Inches   |       |
|           | Min          | Max  | Min      | Max   |
| <b>A</b>  | 0.45         | 0.55 | 0.01     | 0.02  |
| <b>A1</b> | 0.00         | 0.05 | 0.00     | 0.002 |
| <b>A3</b> | 0.127 REF    |      | 0.00 REF |       |
| <b>b</b>  | 0.15         | 0.25 | 0.00     | 0.00  |
| <b>D</b>  | 3.20         | 3.40 | 0.12     | 0.13  |
| <b>D2</b> | 2.70         | 2.90 | 0.10     | 0.11  |
| <b>E</b>  | 1.25         | 1.45 | 0.04     | 0.05  |
| <b>E2</b> | 0.30         | 0.50 | 0.01     | 0.01  |
| <b>e</b>  | 0.40 BSC     |      | 0.01 BSC |       |
| <b>K</b>  | 0.20         |      | 0.00     |       |
| <b>L</b>  | 0.15         | 0.35 | 0.00     | 0.01  |

**Soldering Parameters**

| Reflow Condition                                       |                                    | Pb – Free assembly      |
|--------------------------------------------------------|------------------------------------|-------------------------|
| Pre Heat                                               | - Temperature Min ( $T_{s(min)}$ ) | 150°C                   |
|                                                        | - Temperature Max ( $T_{s(max)}$ ) | 200°C                   |
|                                                        | - Time (min to max) ( $t_s$ )      | 60 – 180 secs           |
| Average ramp up rate (Liquidus Temp ( $T_L$ ) to peak) |                                    | 3°C/second max          |
| $T_{s(max)}$ to $T_L$ - Ramp-up Rate                   |                                    | 3°C/second max          |
| Reflow                                                 | - Temperature ( $T_L$ ) (Liquidus) | 217°C                   |
|                                                        | - Temperature ( $t_L$ )            | 60 – 150 seconds        |
| Peak Temperature ( $T_p$ )                             |                                    | 260 <sup>+0/-5</sup> °C |
| Time within 5°C of actual peak Temperature ( $t_p$ )   |                                    | 20 – 40 seconds         |
| Ramp-down Rate                                         |                                    | 6°C/second max          |
| Time 25°C to peak Temperature ( $T_p$ )                |                                    | 8 minutes Max.          |
| Do not exceed                                          |                                    | 260°C                   |

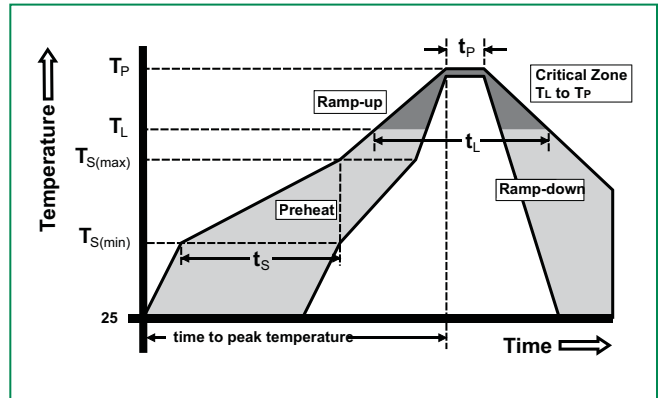

**Package Dimensions — μDFN-12**

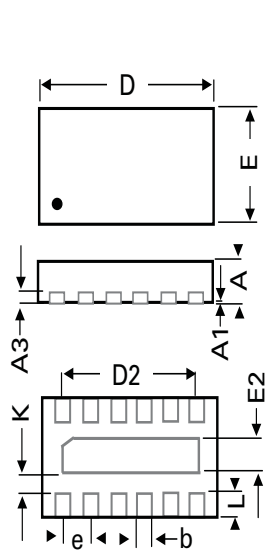

|           | μDFN-12      |       |           |       |
|-----------|--------------|-------|-----------|-------|
|           | JEDEC MO-229 |       |           |       |
|           | Millimeters  |       | Inches    |       |
|           | Min          | Max   | Min       | Max   |
| <b>A</b>  | 0.450        | 0.550 | 0.018     | 0.022 |
| <b>A1</b> | 0.000        | 0.050 | 0.000     | 0.002 |
| <b>A3</b> | 0.127 REF    |       | 0.005 REF |       |
| <b>b</b>  | 0.150        | 0.250 | 0.006     | 0.010 |
| <b>D</b>  | 2.400        | 2.600 | 0.094     | 0.102 |
| <b>D2</b> | 1.900        | 2.100 | 0.075     | 0.083 |
| <b>E</b>  | 1.250        | 1.450 | 0.049     | 0.057 |
| <b>E2</b> | 0.300        | 0.500 | 0.012     | 0.020 |
| <b>e</b>  | 0.400 BSC    |       | 0.016 BSC |       |
| <b>K</b>  | 0.200        |       | 0.008     | 0.000 |
| <b>L</b>  | 0.150        | 0.350 | 0.006     | 0.014 |

**Embossed Carrier Tape & Reel Specification – μDFN-08**

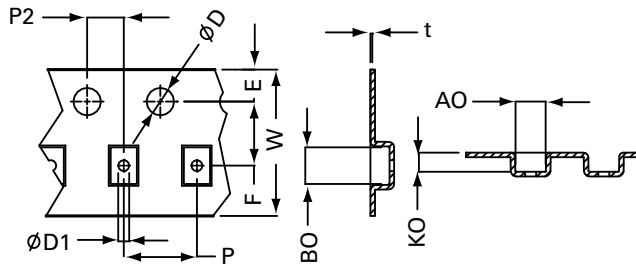

|            | Millimetres   |      | Inches          |       |
|------------|---------------|------|-----------------|-------|
|            | Min           | Max  | Min             | Max   |
| <b>E</b>   | 1.65          | 1.85 | 0.065           | 0.073 |
| <b>F</b>   | 3.45          | 3.55 | 0.136           | 0.140 |
| <b>D1</b>  | 1.00          | -    | 0.040           | -     |
| <b>D</b>   | 1.50 min      |      | 0.059 min       |       |
| <b>P</b>   | 3.90          | 4.10 | 0.154           | 0.161 |
| <b>10P</b> | 40.0 +/- 0.20 |      | 1.575 +/- 0.008 |       |
| <b>W</b>   | 7.70          | 8.30 | 0.303           | 0.327 |
| <b>P2</b>  | 1.95          | 2.05 | 0.077           | 0.081 |
| <b>A0</b>  | 1.55          | 1.75 | 0.061           | 0.069 |
| <b>B0</b>  | 1.90          | 2.1  | 0.075           | 0.083 |
| <b>K0</b>  | 0.95          | 1.15 | 0.037           | 0.045 |
| <b>t</b>   | 0.30 max      |      | 0.012 max       |       |

**Embossed Carrier Tape & Reel Specification – μDFN-12**

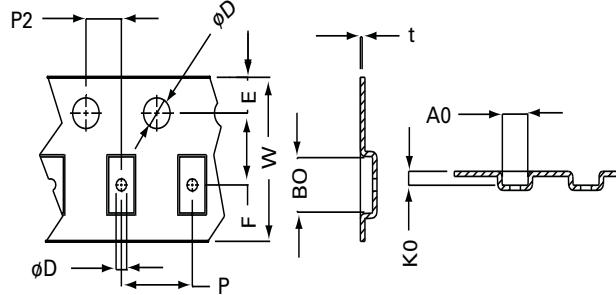

|            | Millimetres   |      | Inches          |       |
|------------|---------------|------|-----------------|-------|
|            | Min           | Max  | Min             | Max   |
| <b>E</b>   | 1.65          | 1.85 | 0.065           | 0.073 |
| <b>F</b>   | 3.45          | 3.55 | 0.136           | 0.140 |
| <b>D1</b>  | 0.55          | 0.65 | 0.021           | 0.025 |
| <b>D</b>   | 1.50 min      |      | 0.059 min       |       |
| <b>P</b>   | 3.90          | 4.10 | 0.154           | 0.161 |
| <b>10P</b> | 40.0 +/- 0.20 |      | 1.575 +/- 0.008 |       |
| <b>W</b>   | 7.90          | 8.30 | 0.311           | 0.327 |
| <b>P2</b>  | 1.95          | 2.05 | 0.077           | 0.081 |
| <b>A0</b>  | 1.33          | 1.53 | 0.052           | 0.060 |
| <b>B0</b>  | 2.63          | 2.83 | 0.103           | 0.111 |
| <b>K0</b>  | 0.58          | 0.78 | 0.023           | 0.031 |
| <b>t</b>   | 0.22 max      |      | 0.009 max       |       |

**Embossed Carrier Tape & Reel Specification – μDFN-16**

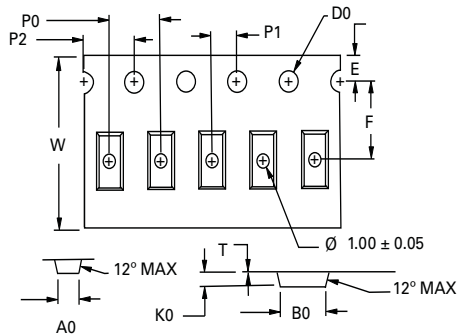

|           | Millimetres |       | Inches |      |
|-----------|-------------|-------|--------|------|
|           | Min         | Max   | Min    | Max  |
| <b>A0</b> | 1.55        | 1.75  | 0.06   | 0.06 |
| <b>B0</b> | 3.50        | 3.70  | 0.13   | 0.14 |
| <b>D0</b> | 1.40        | 1.60  | 0.05   | 0.06 |
| <b>E</b>  | 1.65        | 1.85  | 0.06   | 0.07 |
| <b>F</b>  | 5.45        | 5.55  | 0.21   | 0.21 |
| <b>K0</b> | 0.85        | 1.05  | 0.03   | 0.04 |
| <b>P0</b> | 3.90        | 4.10  | 0.15   | 0.16 |
| <b>P1</b> | 1.95        | 2.05  | 0.07   | 0.08 |
| <b>P2</b> | 3.90        | 4.10  | 0.15   | 0.16 |
| <b>T</b>  | 0.26        | 0.30  | 0.01   | 0.01 |
| <b>W</b>  | 11.90       | 12.30 | 0.46   | 0.48 |

**Part Numbering System**

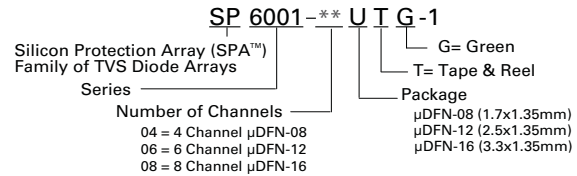

**Part Marking System**

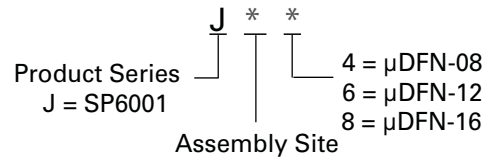

**Ordering Information**

| Part Number    | Package | Size (mm) | Marking | Min. Order Qty. |
|----------------|---------|-----------|---------|-----------------|
| SP6001-04UTG-1 | μDFN-08 | 1.7x1.35  | J*4     | 3000            |
| SP6001-06UTG-1 | μDFN-12 | 2.5x1.35  | J*6     | 3000            |
| SP6001-08UTG-1 | μDFN-16 | 3.3x1.35  | J*8     | 3000            |