

# SP1026 Series 15pF 30kV Bidirectional Discrete TVS



## Description

The SP1026 back-to-back diodes are fabricated in a proprietary silicon avalanche technology. These diodes provide a high ESD (electrostatic discharge) protection level for electronic equipment. The SP1026 TVS can safely absorb repetitive ESD strikes at  $\pm 30\text{kV}$  (contact discharge, IEC 61000-4-2) without performance degradation. Additionally, each diode can safely dissipate 5A of 8/20 $\mu\text{s}$  surge current (IEC 61000-4-5) with very low clamping voltages.

## Pinout

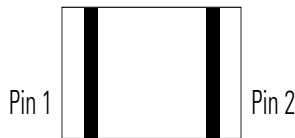

## Features

- ESD, IEC 61000-4-2,  $\pm 30\text{kV}$  contact,  $\pm 30\text{kV}$  air
- EFT, IEC 61000-4-4, 40A (5/50ns)
- Lightning, 5A (8/20 $\mu\text{s}$  as defined in IEC 61000-4-5 2<sup>nd</sup> edition)
- Low leakage current of 0.5 $\mu\text{A}$  (MAX) at 5V
- Space efficient 0201 footprint
- Halogen free, Lead free and RoHS compliant
- $\mu\text{DFN-2}$  footprint component
- AEC-Q101 qualified

## Functional Block Diagram

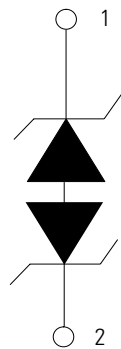

## Applications

- Mobile phones
- Smart phones
- Smart watches
- Tablets
- Portable navigation devices
- Portable medical devices

## Application Example

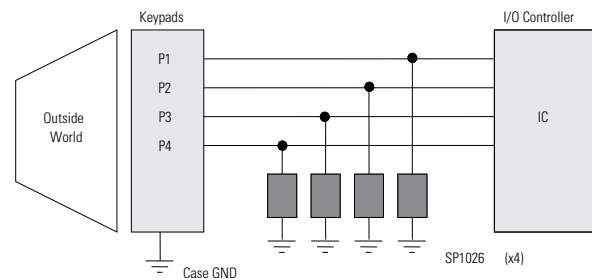

Life Support Note:

**Not Intended for Use in Life Support or Life Saving Applications**

The products shown herein are not designed for use in life sustaining or life saving applications unless otherwise expressly indicated.

### Absolute Maximum Ratings

Symbol	Parameter	Value	Units
$I_{PP}$	Peak Pulse Current ( $t_p=8/20\mu s$ )	5	A
$T_{OP}$	Operating Temperature	-40 to 125	°C
$T_{STOR}$	Storage Temperature	-55 to 150	°C

**CAUTION:** Stresses above those listed in "Absolute Maximum Ratings" may cause permanent damage to the component. This is a stress only rating and operation of the component at these or any other conditions above those indicated in the operational sections of this specification is not implied.

### Electrical Characteristics ( $T_{OP}=25^\circ C$ )

Parameter	Symbol	Test Conditions	Min	Typ	Max	Units
Reverse Standoff Voltage	$V_{RWM}$	$I_R = 1\mu A$	-	-	6.0	V
Breakdown Voltage	$V_{BR}$	$I_R = 1mA$	-	7.8	-	V
Reverse Leakage Current	$I_{LEAK}$	$V_R = 5V$	-	0.1	0.5	$\mu A$
Clamp Voltage <sup>1</sup>	$V_C$	$I_{PP} = 1A, t_p = 8/20\mu s$	-	12.0	-	V
		$I_{PP} = 2A, t_p = 8/20\mu s$	-	13.4	-	V
Diode Capacitance <sup>2</sup>	$R_{DYN}$	TLP, $t_p = 100ns$ , I/O to GND	-	1.4	-	$\Omega$
ESD Withstand Voltage <sup>1</sup>	$V_{ESD}$	IEC 61000-4-2 (Contact Discharge)	$\pm 30$	-	-	kV
		IEC 61000-4-2 (Air Discharge)	$\pm 30$	-	-	kV
Diode Capacitance <sup>1</sup>	$C_{I/O-I/O}$	Reverse Bias=0V, $f = 1 MHz$	-	15	-	pF
		Reverse Bias=2.5V, $f = 1 MHz$	-	12	-	pF

1 - Parameter is guaranteed by design and/or component characterization.

2 - Transmission Line Pulse(TLP) with 100ns width, 2ns rise time, and average window  $t_1=70ns$  to  $t_2=90ns$ .

### Capacitance vs. Reverse Bias

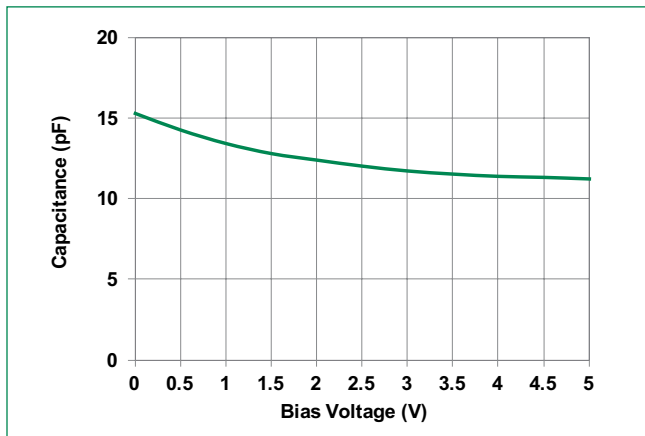

### Insertion Loss (S21) I/O to GND

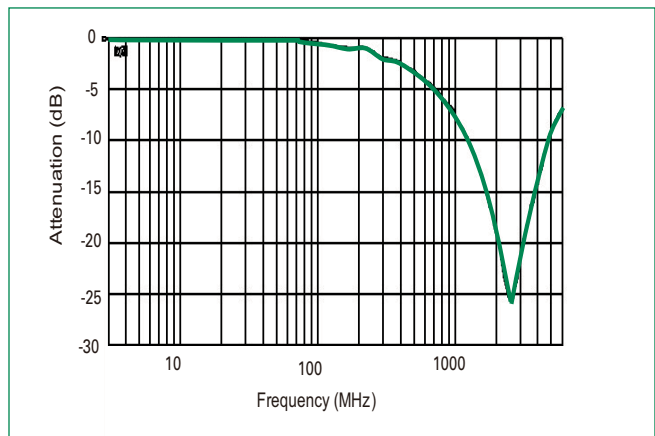

**Clamping Voltage vs.  $I_{PP}$**

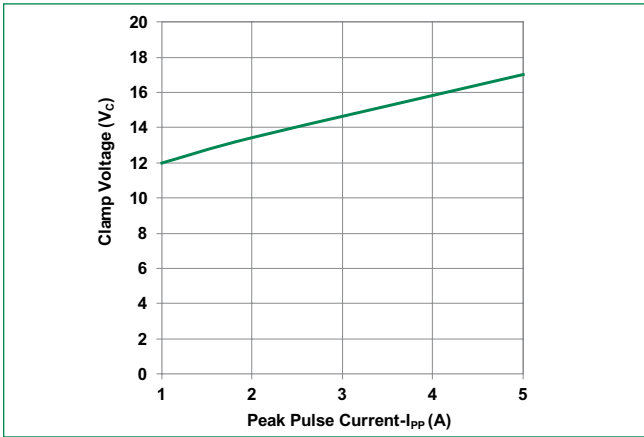

**Transmission Line Pulsing(TLP) Plot**

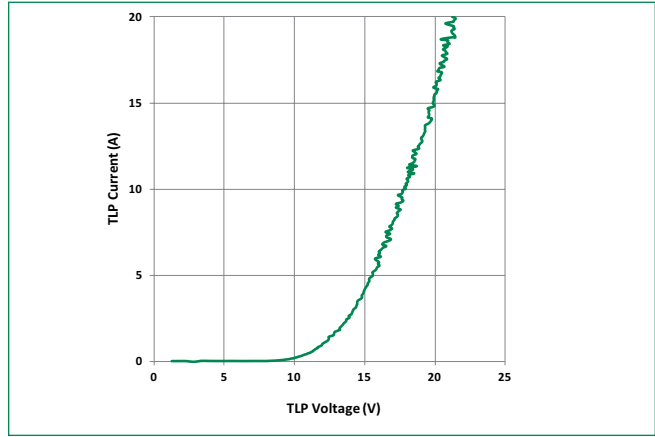

**8/20 $\mu$ S Pulse Waveform**

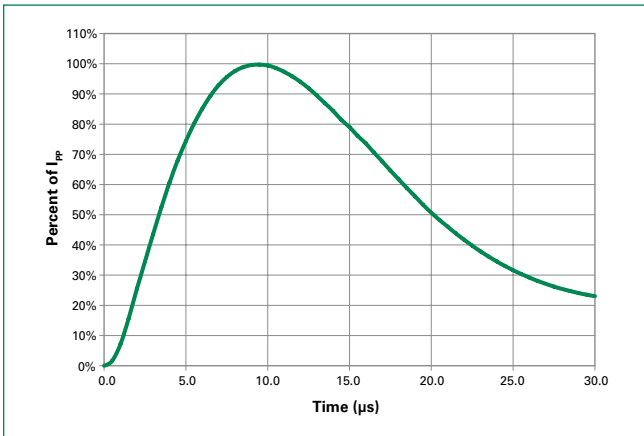

**IEC61000-4-2 +8 kV Contact ESD Clamping Voltage**



**IEC61000-4-2 -8 kV Contact ESD Clamping Voltage**

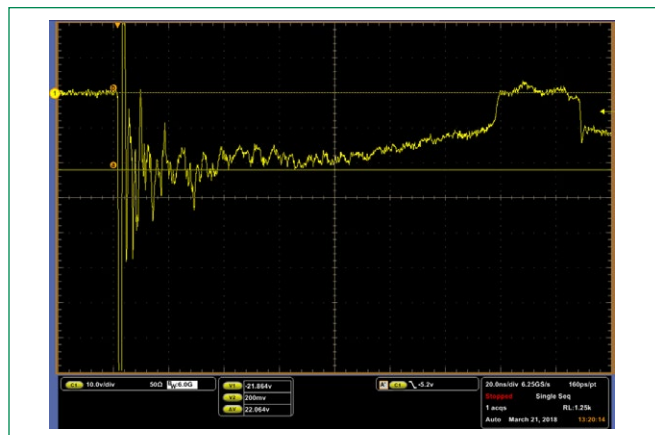

### Soldering Parameters

<b>Reflow Condition</b>		Pb – Free assembly
<b>Pre Heat</b>	- Temperature Min ( $T_{s(min)}$ )	150°C
	- Temperature Max ( $T_{s(max)}$ )	200°C
	- Time (min to max) ( $t_s$ )	60 – 180 secs
<b>Average ramp up rate (Liquidus) Temp (<math>T_L</math>) to peak</b>		3°C/second max
<b><math>T_{s(max)}</math> to <math>T_L</math> - Ramp-up Rate</b>		3°C/second max
<b>Reflow</b>	- Temperature ( $T_L$ ) (Liquidus)	217°C
	- Temperature ( $t_L$ )	60 – 150 seconds
<b>Peak Temperature (<math>T_p</math>)</b>		260 <sup>+0/-5</sup> °C
<b>Time within 5°C of actual peak Temperature (<math>t_p</math>)</b>		20 – 40 seconds
<b>Ramp-down Rate</b>		6°C/second max
<b>Time 25°C to peak Temperature (<math>T_p</math>)</b>		8 minutes Max.

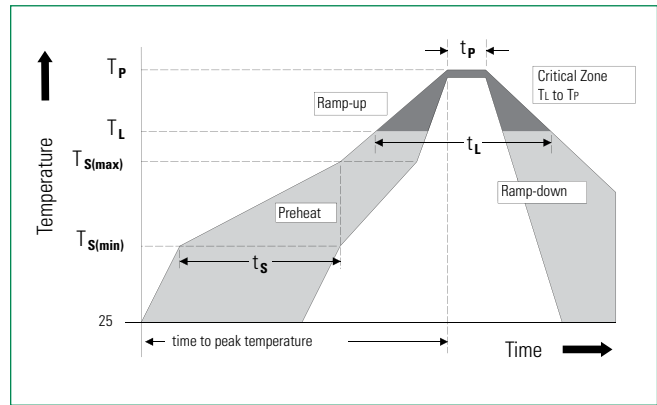

### Product Characteristics

<b>Lead Plating</b>	Pre-Plated Frame
<b>Lead Material</b>	Copper Alloy
<b>Substrate material</b>	Silicon
<b>Body Material</b>	Molded Epoxy
<b>Flammability</b>	UL Recognized epoxy meeting flammability rating V-0

### Package Dimensions – $\mu$ DFN-2 (0201)

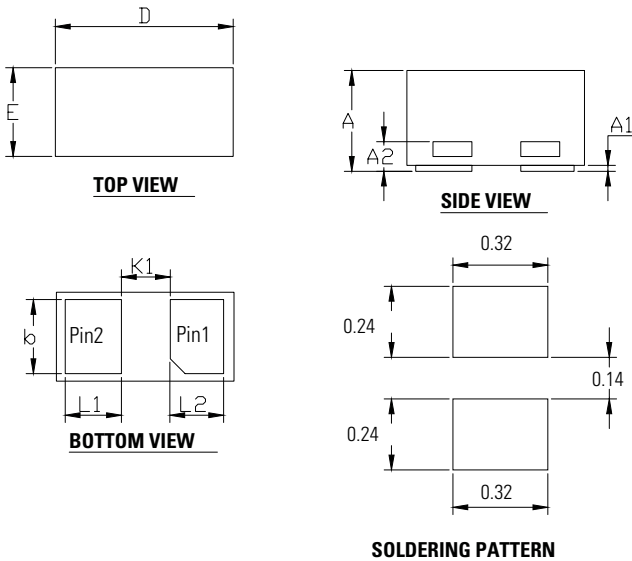

Package	$\mu$ DFN-2 (0201)			
	JEDEC MO-236			
	Millimeters		Inches	
Symbol	Min	Max	Min	Max
<b>A</b>	0.23	0.33	0.009	0.013
<b>A1</b>	0.00	0.05	0.000	0.002
<b>A2</b>	0.10 REF		0.004 REF	
<b>b</b>	0.18	0.30	0.007	0.012
<b>D</b>	0.55	0.65	0.022	0.026
<b>E</b>	0.25	0.35	0.010	0.014
<b>L1</b>	0.12	0.24	0.005	0.009
<b>L2</b>	0.12	0.23	0.005	0.009
<b>K1</b>	0.165 REF		0.006 REF	

**Part Numbering System**

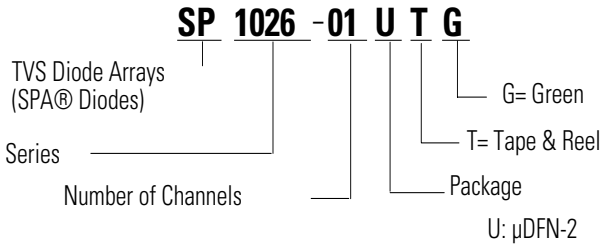

**Ordering Information**

Part Number	Package	Min. Order Qty.
SP1026-01UTG	$\mu$ DFN-2	15000

**Part Marking System**



**Embossed Carrier Tape & Reel Specification –  $\mu$ DFN-2**

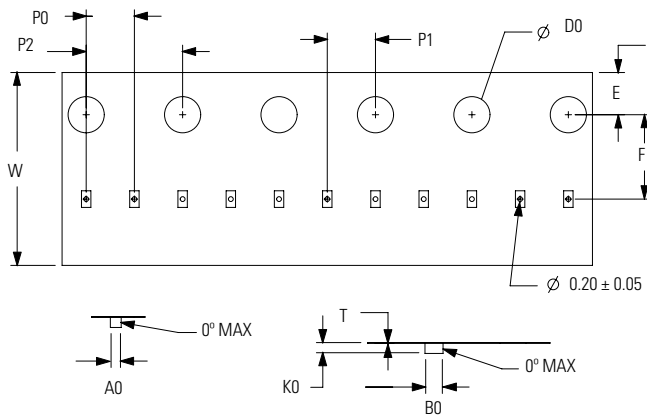

Symbol	Millimetres		Inches	
	Min	Max	Min	Max
<b>A0</b>	0.33	0.40	0.013	0.016
<b>B0</b>	0.63	0.70	0.025	0.028
<b>D0</b>	1.40	1.60	0.055	0.063
<b>E</b>	1.65	1.85	0.065	0.073
<b>F</b>	3.45	3.55	0.136	0.140
<b>K0</b>	0.30	0.39	0.012	0.015
<b>P0</b>	1.90	2.10	0.075	0.083
<b>P1</b>	1.95	2.05	0.077	0.081
<b>P2</b>	3.90	4.10	0.154	0.161
<b>T</b>	0.13	0.25	0.005	0.010
<b>W</b>	7.90	8.30	0.311	0.327

