

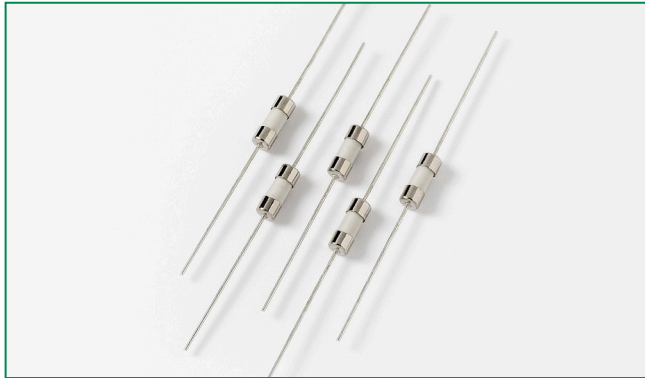



677 Series, 3.6x10mm, Time-Lag Fuse



Agency Approvals

Agency	Agency File Number	Ampere Range
	CQC09012032902	0.250 - 6.3A
	222984	0.250 - 6.3A
	E10480	0.250 - 6.3A
	40006258	0.250 - 6.3A

Additional Information



Datashheet



Resources



Samples

Description

The 3.6 x 10mm Time-Lag Fuse with ceramic body construction permits higher interrupting ratings and voltage ratings. Ideal for applications where high current loads are expected.

Features

- Available in cartridge and axial lead format and with various forming dimensions
- Halogen free, Lead-free and RoHS compliant
- Meets the requirements of IEC 60127-3, Standard Sheet 4.
- Time-Lag, ceramic body fuse in a compact package.





Applications

- Lighting
- Adapter applications
- Power supply

Electrical Characteristics for Series

% of Ampere Rating	Opening Time
150%	60 minutes, Minimum
210%	2 minutes, Maximum
275%	400msec., Min.; 10 sec. Max.
400%	150msec., Min.; 0.3 sec. Max.
1000%	20msec., Min.; 150msec Max.

Electrical Specification by Item

Ampere Rating (A)	Amp Code	Voltage Rating (V)	Interrupting Rating	Nominal Cold Resistance (Ohms)	Nominal Melting I ² t (A ² sec)	Agency Approvals			
									
.250	.250	250	35A@250VAC	0.00063	0.312	x	x	x	x
.315	.315	250		0.00046	0.422	x	x	x	x
.400	.400	250		0.00036	0.755	x	x	x	x
.500	.500	250		0.00031	1.32	x	x	x	x
.630	.630	250		0.000178	2.55	x	x	x	x
.800	.800	250		0.000125	3.25	x	x	x	x
001.	001.	250		0.000092	6.95	x	x	x	x
002.	002.	250		0.000035	20.8	x	x	x	x
004.	004.	250	40A@250VAC	0.000016	95	x	x	x	x
005.	006.	250	50A@250VAC	0.000014	140	x	x	x	x
01.6	01.6	250	35A@250VAC	0.000048	18.2	x	x	x	x
02.5	02.5	250		0.000028	32.5	x	x	x	x
06.3	06.3	280	63A@250VAC	0.000009	240	x	x	x	x
1.25	1.25	250	35A@250VAC	0.000065	12.1	x	x	x	x
3.15	3.15	250		0.00002	40.8	x	x	x	x

I²t test at 10x rated current

Temperature Re-rating Curve

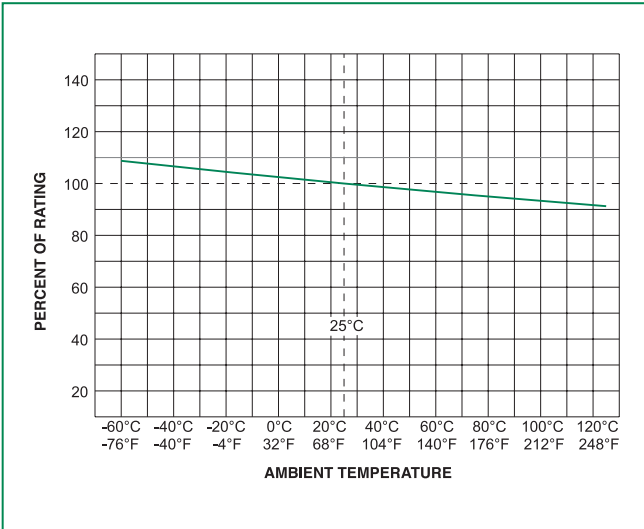

Note:
Rerating depicted in this curve is in addition to the standard derating of 25% for continuous operation.

Average Time Current Curves

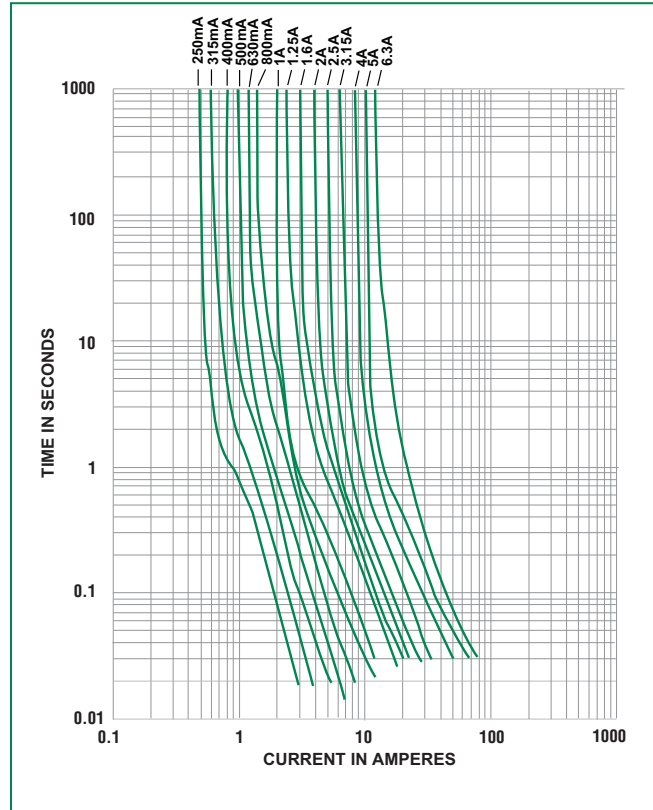

Soldering Parameters - Wave Soldering

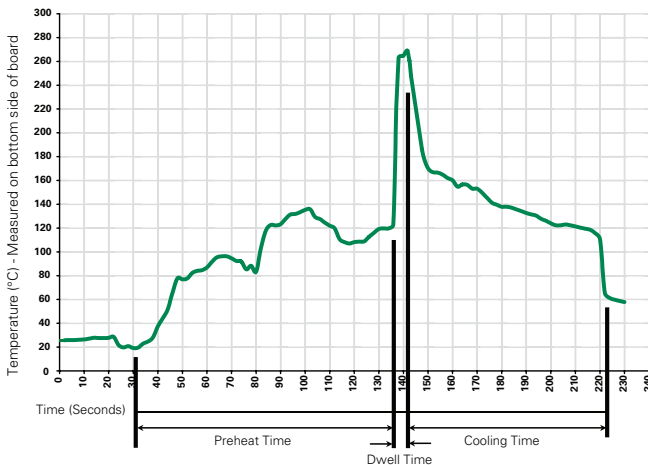

Recommended Process Parameters:

Wave Parameter	Lead-Free Recommendation
Preheat: (Depends on Flux Activation Temperature)	(Typical Industry Recommendation)
Temperature Minimum:	100°C
Temperature Maximum:	150°C
Preheat Time:	60-180 seconds
Solder Pot Temperature:	260°C Maximum
Solder Dwell Time:	2-5 seconds

Recommended Hand-Solder Parameters:

Solder Iron Temperature: 350°C +/- 5°C
Heating Time: 5 seconds max.

Note: These devices are not recommended for IR or Convection Reflow process.

Product Characteristics

Materials	Body: Ceramic Cap: Nickel-plated Brass Leads: Tin-plated Copper
Terminal Strength	MIL-STD-202, Method 211, Test Condition A
Solderability	MIL-STD-202 Method 208
Product Marking	Cap1: Brand logo, current and voltage ratings Cap2: Series and agency approval marks

Operating Temperature	-55°C to +125°C
Thermal Shock	MIL-STD-202, Method 107, Test Condition B (5 cycles, -65°C to +125°C)
Vibration	MIL-STD-202, Method 201
Humidity	MIL-STD-202, Method 103, Test Condition A (High RH (95%) and Elevated temperature (40°C) for 240 hours)
Salt Spray	MIL-STD-202, Method 101, Test Condition B

Dimensions

Measurements displayed in millimeters (inches)

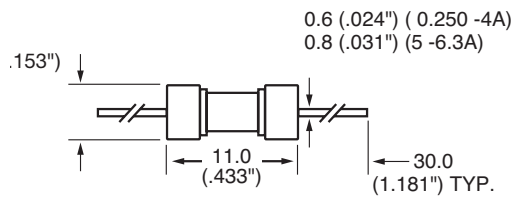

Axial Lead Material: Solder coated copper.

Part Numbering System

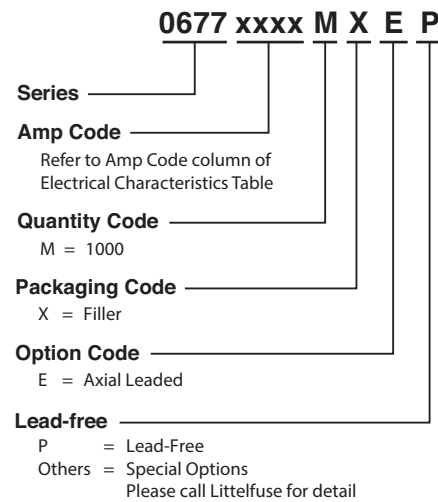

Packaging

Packaging Option	Packaging Specification	Quantity	Quantity and Packaging Code	Taping Width
Bulk	N/A	1000	MXE	N/A
Tape and Reel	EIA-296	1500	DRT4	56.5mm