

**High Voltage  
XPT™ IGBT  
w/ Diode**
**IXYK30N170CV1  
IXYX30N170CV1**

$$V_{CES} = 1700V$$

$$I_{C110} = 30A$$

$$V_{CE(sat)} \leq 4.0V$$

$$t_{fi(typ)} = 95ns$$

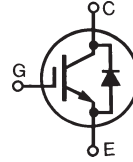

Symbol	Test Conditions	Maximum Ratings	
$V_{CES}$	$T_J = 25^\circ C$ to $175^\circ C$	1700	V
$V_{CGR}$	$T_J = 25^\circ C$ to $175^\circ C$ , $R_{GE} = 1M\Omega$	1700	V
$V_{GES}$	Continuous	$\pm 20$	V
$V_{GEM}$	Transient	$\pm 30$	V
$I_{C25}$	$T_C = 25^\circ C$	100	A
$I_{C110}$	$T_C = 110^\circ C$	30	A
$I_{F110}$	$T_C = 110^\circ C$	38	A
$I_{CM}$	$T_C = 25^\circ C$ , 1ms	250	A
<b>SSOA (RBSOA)</b>	$V_{GE} = 15V$ , $T_{VJ} = 150^\circ C$ , $R_G = 2.7\Omega$ Clamped Inductive Load	$I_{CM} = 120$ 1360	A V
$P_C$	$T_C = 25^\circ C$	937	W
$T_J$		-55 ... +175	$^\circ C$
$T_{JM}$		175	$^\circ C$
$T_{stg}$		-55 ... +175	$^\circ C$
$T_L$	Maximum Lead Temperature for Soldering	300	$^\circ C$
$T_{SOLD}$	1.6 mm (0.062in.) from Case for 10s	260	$^\circ C$
$M_d$	Mounting Torque (TO-264)	1.13/10	Nm/lb.in
$F_C$	Mounting Force (PLUS247)	20..120 / 4.5..27	N/lb
<b>Weight</b>	TO-264	10	g
	PLUS247	6	g

TO-264 (IXYK)

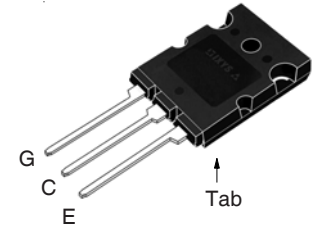

PLUS247 (IXYX)

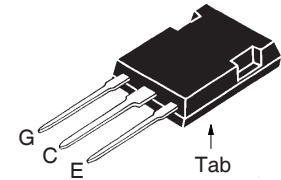

G = Gate      D = Collector  
S = Emitter    Tab = Collector

**Features**

- International Standard Packages
- High Voltage Package
- High Blocking Voltage
- Low Saturation Voltage

**Advantages**

- Low Gate Drive Requirement
- High Power Density

**Applications**

- Switch-Mode and Resonant-Mode Power Supplies
- Uninterruptible Power Supplies (UPS)
- Laser Generators
- Capacitor Discharge Circuits
- AC Switches

Symbol	Test Conditions ( $T_J = 25^\circ C$ , Unless Otherwise Specified)	Characteristic Values		
		Min.	Typ.	Max.
$BV_{CES}$	$I_C = 250\mu A$ , $V_{GE} = 0V$	1700		V
$V_{GE(th)}$	$I_C = 250\mu A$ , $V_{CE} = V_{GE}$	3.0		V
$I_{CES}$	$V_{CE} = 0.8 \cdot V_{CES}$ , $V_{GE} = 0V$ $T_J = 125^\circ C$			25 $\mu A$ 4 mA
$I_{GES}$	$V_{CE} = 0V$ , $V_{GE} = \pm 20V$			$\pm 100$ nA
$V_{CE(sat)}$	$I_C = 30A$ , $V_{GE} = 15V$ , Note 1 $T_J = 150^\circ C$		3.5 4.6	V V

Symbol Test Conditions		Characteristic Values		
(T <sub>J</sub> = 25°C Unless Otherwise Specified)		Min.	Typ.	Max.
<b>g<sub>fs</sub></b>	I <sub>C</sub> = 30A, V <sub>CE</sub> = 10V, Note 1	17	28	S
<b>R<sub>Gi</sub></b>	Gate Input Resistance		2.8	Ω
<b>C<sub>ies</sub></b>	V <sub>CE</sub> = 25V, V <sub>GE</sub> = 0V, f = 1MHz		3100	pF
<b>C<sub>oes</sub></b>			210	pF
<b>C<sub>res</sub></b>			55	pF
<b>Q<sub>g(on)</sub></b>	I <sub>C</sub> = 30A, V <sub>GE</sub> = 15V, V <sub>CE</sub> = 0.5 • V <sub>CES</sub>		150	nC
<b>Q<sub>ge</sub></b>			15	nC
<b>Q<sub>gc</sub></b>			65	nC
<b>t<sub>d(on)</sub></b>	<b>Inductive load, T<sub>J</sub> = 25°C</b> I <sub>C</sub> = 30A, V <sub>GE</sub> = 15V V <sub>CE</sub> = 0.5 • V <sub>CES</sub> , R <sub>G</sub> = 2.7Ω Note 2		16	ns
<b>t<sub>ri</sub></b>			33	ns
<b>E<sub>on</sub></b>			3.6	mJ
<b>t<sub>d(off)</sub></b>			143	ns
<b>t<sub>fi</sub></b>			95	ns
<b>E<sub>off</sub></b>			1.8	mJ
<b>t<sub>d(on)</sub></b>	<b>Inductive load, T<sub>J</sub> = 150°C</b> I <sub>C</sub> = 30A, V <sub>GE</sub> = 15V V <sub>CE</sub> = 0.5 • V <sub>CES</sub> , R <sub>G</sub> = 2.7Ω Note 2		16	ns
<b>t<sub>ri</sub></b>			33	ns
<b>E<sub>on</sub></b>			5.5	mJ
<b>t<sub>d(off)</sub></b>			193	ns
<b>t<sub>fi</sub></b>			134	ns
<b>E<sub>off</sub></b>			3.5	mJ
<b>R<sub>thJC</sub></b>				0.16 °C/W
<b>R<sub>thCS</sub></b>			0.15	°C/W

**Reverse Diode (FRED)**

Symbol Test Conditions		Characteristic Value		
(T <sub>J</sub> = 25°C, Unless Otherwise Specified)		Min.	Typ.	Max.
<b>V<sub>F</sub></b>	I <sub>F</sub> = 30A, V <sub>GE</sub> = 0V, Note 1			3.5 V
<b>I<sub>RM</sub></b>	I <sub>F</sub> = 30A, V <sub>GE</sub> = 0V, -di <sub>F</sub> /dt = 500A/μs, V <sub>R</sub> = 1200V, T <sub>J</sub> = 150°C		3.7	V
<b>t<sub>rr</sub></b>			32	A
<b>R<sub>thJC</sub></b>				0.36°C/W

**Notes:**

1. Pulse test, t ≤ 300μs, duty cycle, d ≤ 2%.
2. Switching times & energy losses may increase for higher V<sub>CE</sub>(clamp), T<sub>J</sub> or R<sub>G</sub>.

**PRELIMINARY TECHNICAL INFORMATION**

The product presented herein is under development. The Technical Specifications offered are derived from a subjective evaluation of the design, based upon prior knowledge and experience, and constitute a "considered reflection" of the anticipated result. IXYS reserves the right to change limits, test conditions, and dimensions without notice.

IXYS Reserves the Right to Change Limits, Test Conditions, and Dimensions.

IXYS MOSFETs and IGBTs are covered by one or more of the following U.S. patents:	4,835,592	4,931,844	5,049,961	5,237,481	6,162,665	6,404,065 B1	6,683,344	6,727,585	7,005,734 B2	7,157,338B2
	4,860,072	5,017,508	5,063,307	5,381,025	6,259,123 B1	6,534,343	6,710,405 B2	6,759,692	7,063,975 B2	
	4,881,106	5,034,796	5,187,117	5,486,715	6,306,728 B1	6,583,505	6,710,463	6,771,478 B2	7,071,537	

**TO-264 Outline**

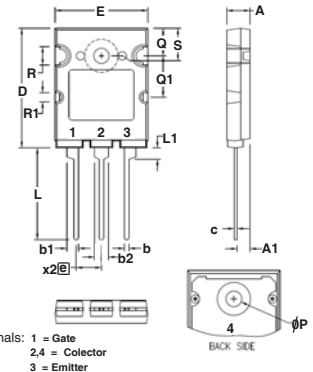

Terminals: 1 = Gate  
2,4 = Collector  
3 = Emitter

SYM	INCHES		MILLIMETERS	
	MIN	MAX	MIN	MAX
A	.185	.209	4.70	5.30
A1	.102	.118	2.60	3.00
b	.035	.049	0.90	1.25
b1	.091	.106	2.30	2.70
b2	.110	.126	2.80	3.20
c	.020	.033	0.50	0.85
D	1.012	1.035	25.70	26.30
E	.776	.799	19.70	20.30
e	.215BSC		5.46 BSC	
L	.768	.807	19.50	20.50
L1	.091	.106	2.30	2.70
φP	.122	.138	3.10	3.50
Q	.228	.244	5.80	6.20
Q1	.346	.362	8.80	9.20
φR	.150	.165	3.80	4.20
φR1	.071	.087	1.80	2.20
S	.228	.244	5.80	6.20

**PLUS 247™ Outline**

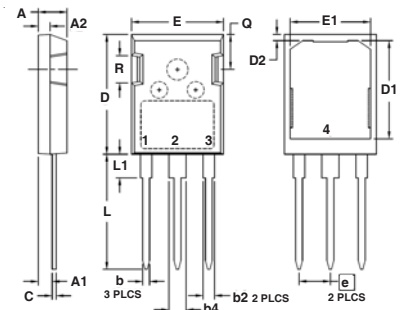

Terminals: 1 - Gate  
2,4 - Collector  
3 - Emitter

SYM	INCHES		MILLIMETERS	
	MIN	MAX	MIN	MAX
A	.190	.205	4.83	5.21
A1	.090	.100	2.29	2.54
A2	.075	.085	1.91	2.16
b	.045	.055	1.14	1.40
b2	.075	.087	1.91	2.20
b4	.115	.126	2.92	3.20
C	.024	.031	0.61	0.80
D	.819	.840	20.80	21.34
D1	.650	.690	16.51	17.53
D2	.035	.050	0.89	1.27
E	.620	.635	15.75	16.13
E1	.520	.560	13.08	14.22
e	.215 BSC		5.45 BSC	
L	.780	.810	19.81	20.57
L1	.150	.170	3.81	4.32
Q	.220	.244	5.59	6.20
R	.170	.190	4.32	4.83

Fig. 1. Output Characteristics @  $T_J = 25^\circ\text{C}$

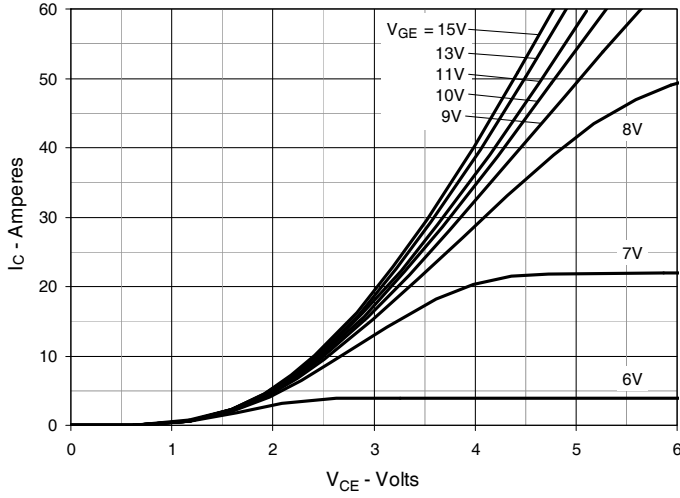

Fig. 2. Extended Output Characteristics @  $T_J = 25^\circ\text{C}$

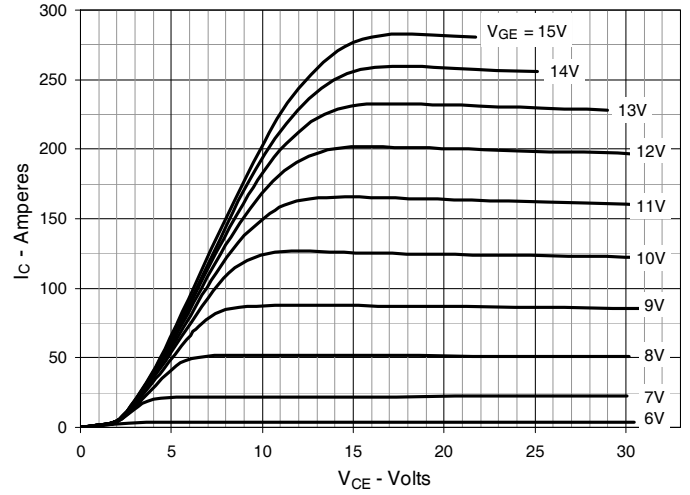

Fig. 3. Output Characteristics @  $T_J = 150^\circ\text{C}$

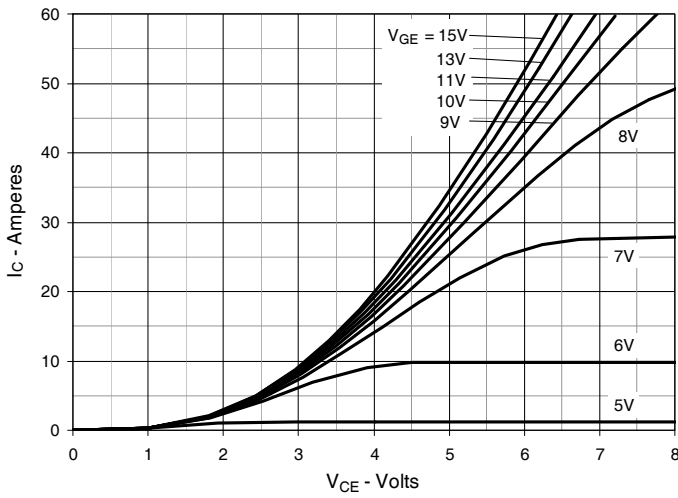

Fig. 4. Dependence of  $V_{CE(sat)}$  on Junction Temperature

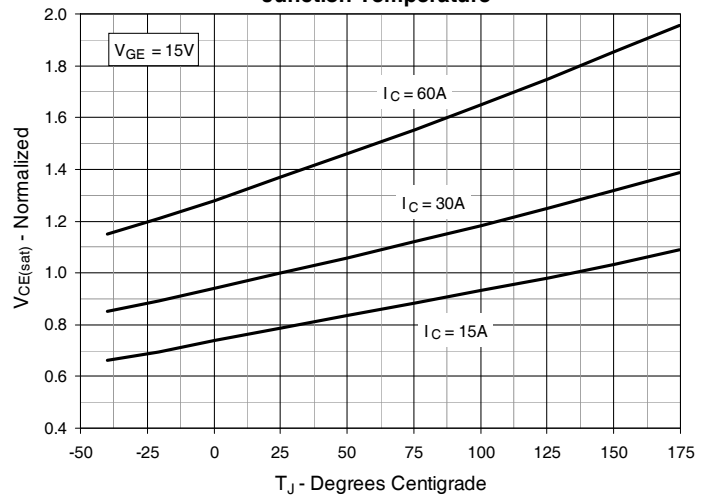

Fig. 5. Collector-to-Emitter Voltage vs. Gate-to-Emitter Voltage

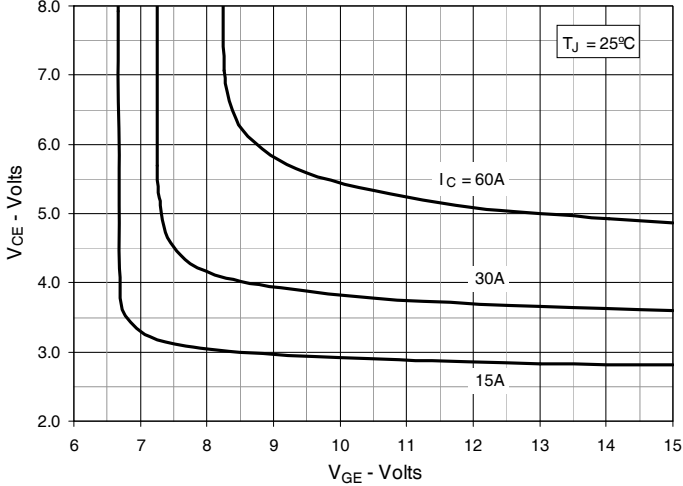
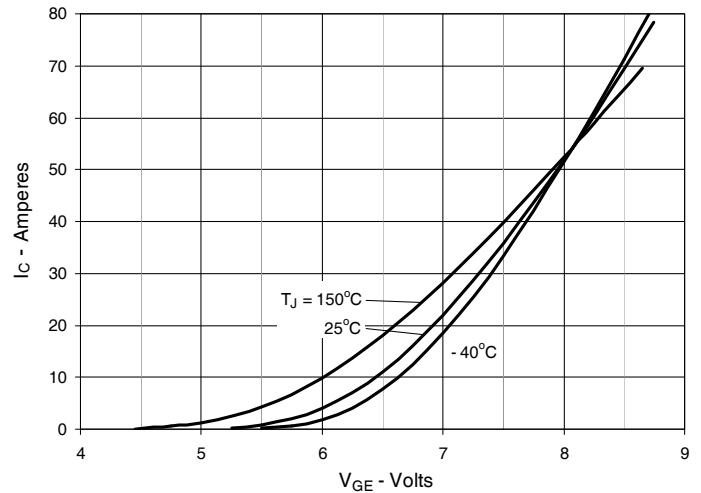
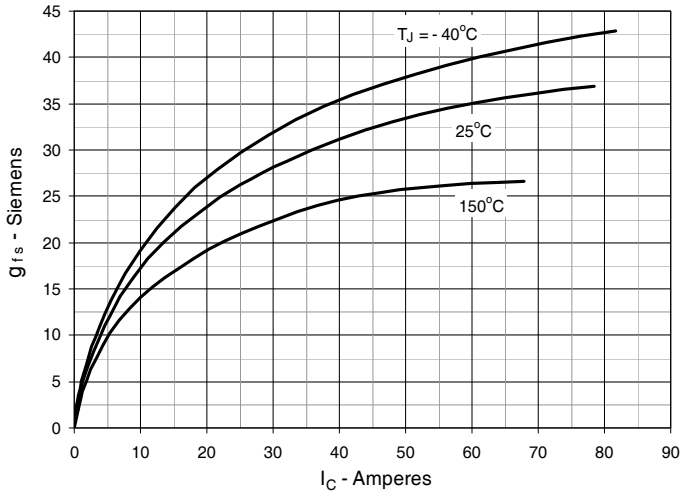

Fig. 6. Input Admittance



**Fig. 7. Transconductance**



**Fig. 8. Gate Charge**

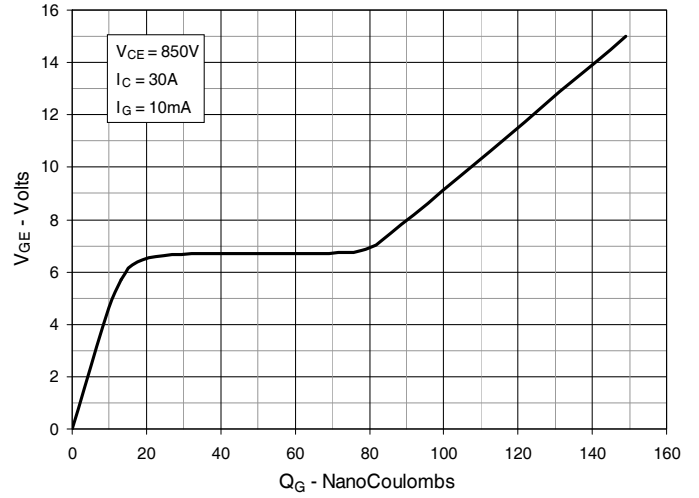

**Fig. 9. Capacitance**

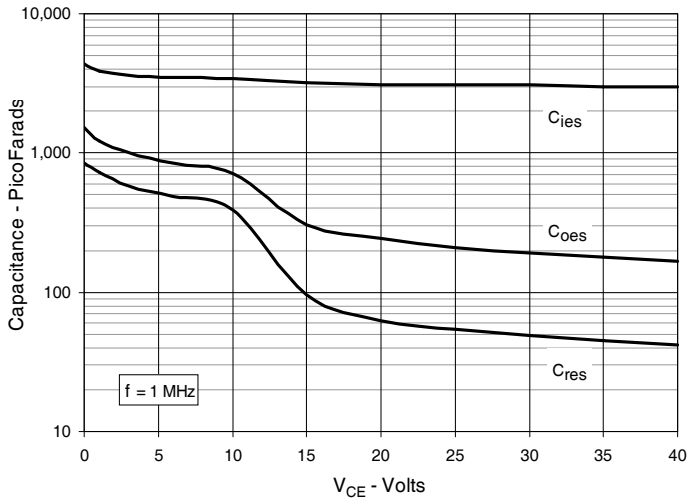

**Fig. 10. Reverse-Bias Safe Operating Area**

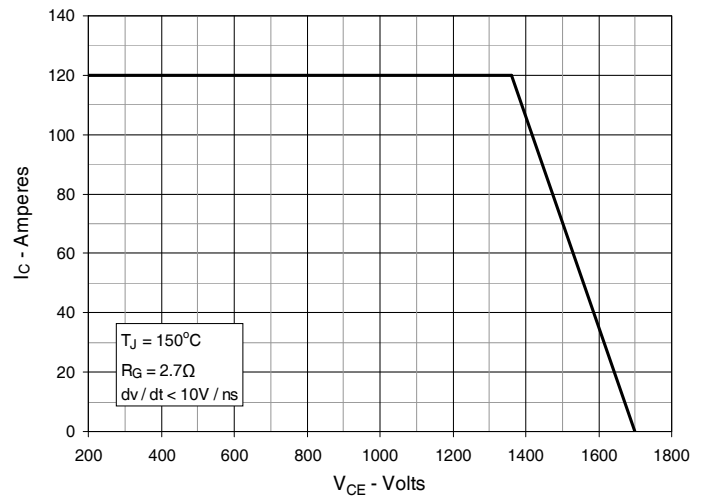

**Fig. 11. Maximum Transient Thermal Impedance (IGBT)**

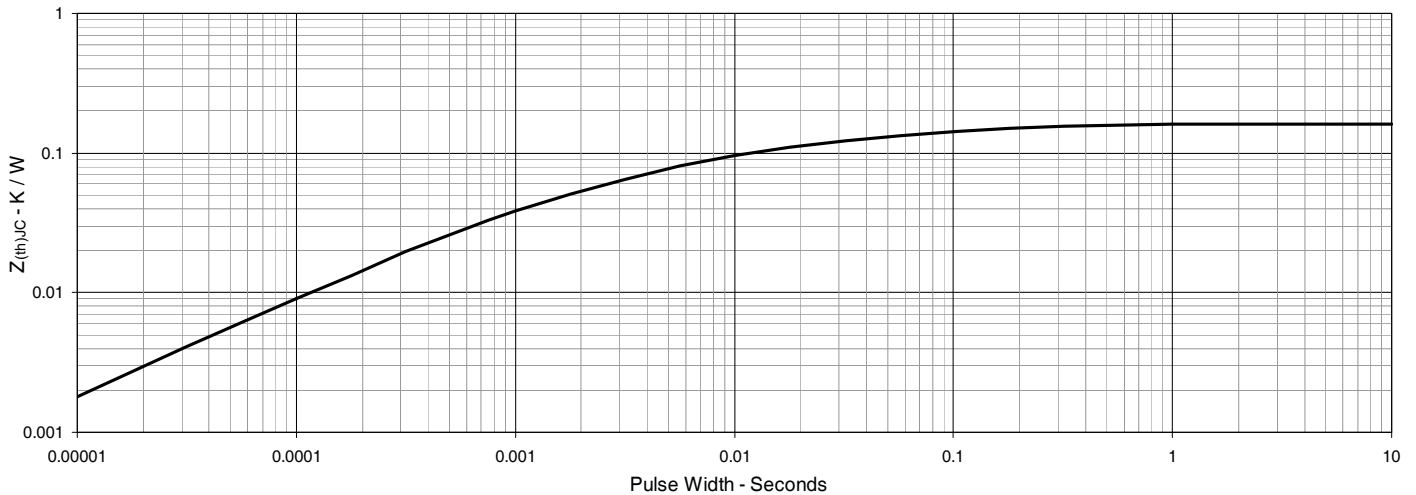

**Fig. 12. Inductive Switching Energy Loss vs. Gate Resistance**

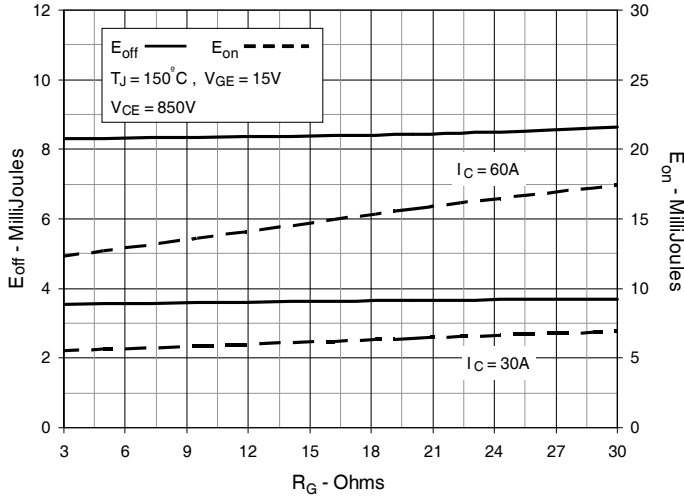

**Fig. 13. Inductive Switching Energy Loss vs. Collector Current**

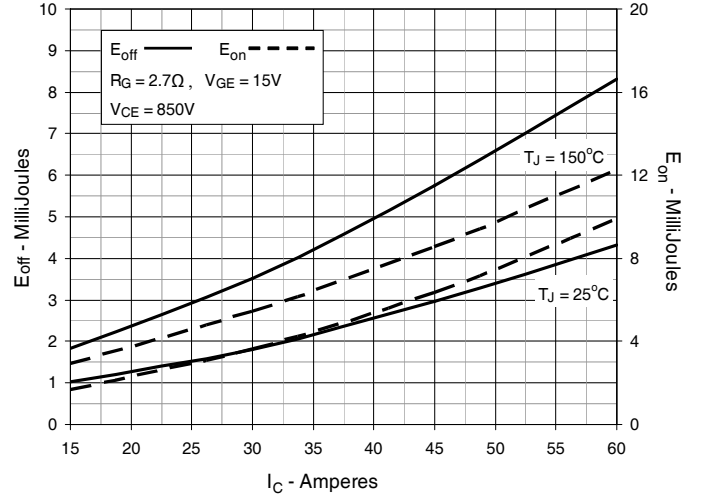

**Fig. 14. Inductive Switching Energy Loss vs. Junction Temperature**

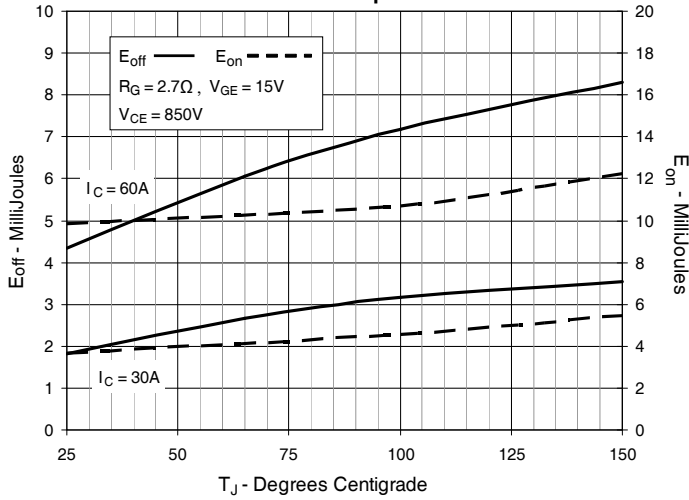

**Fig. 15. Inductive Turn-off Switching Times vs. Gate Resistance**

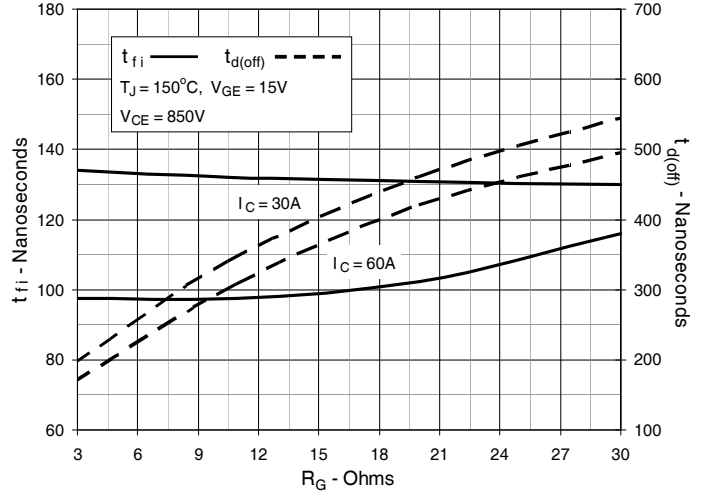

**Fig. 16. Inductive Turn-off Switching Times vs. Collector Current**

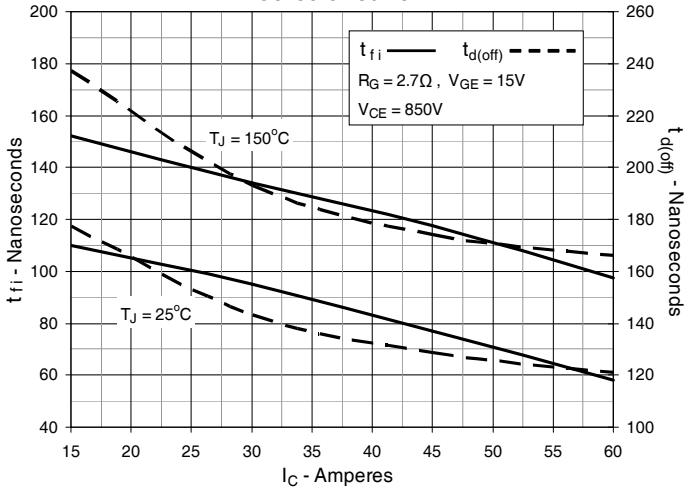

**Fig. 17. Inductive Turn-off Switching Times vs. Junction Temperature**

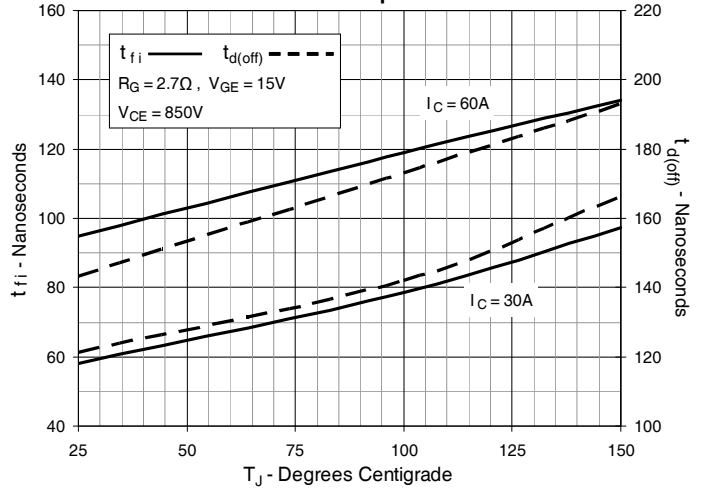

**Fig. 18. Inductive Turn-on Switching Times vs. Gate Resistance**

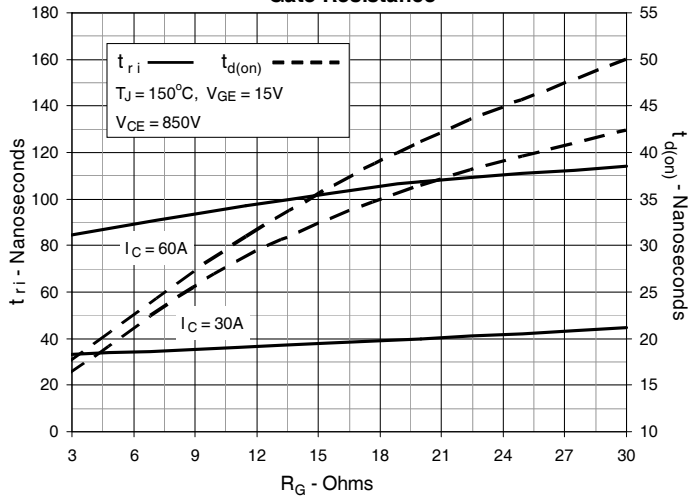

**Fig. 19. Inductive Turn-on Switching Times vs. Collector Current**

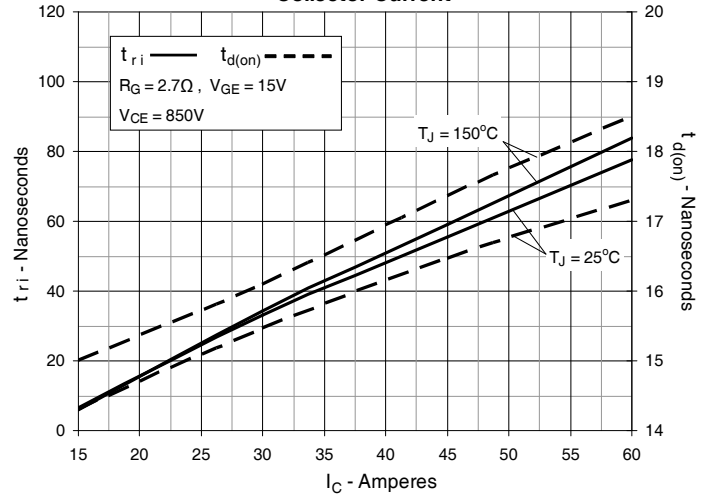

**Fig. 20. Inductive Turn-on Switching Times vs. Junction Temperature**

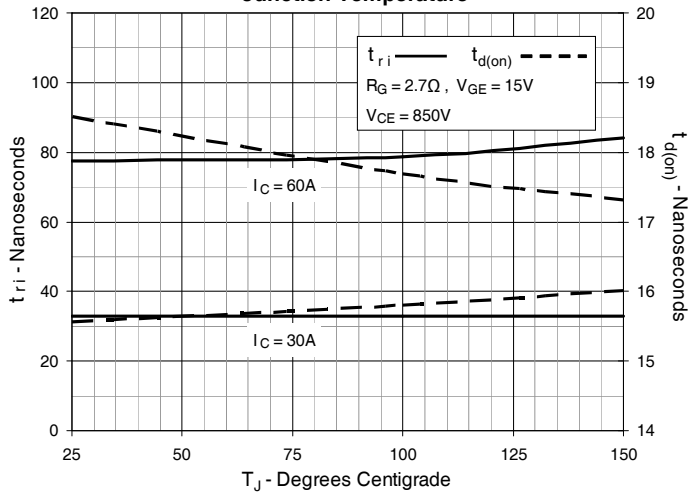

Fig. 21. Diode Forward Characteristics

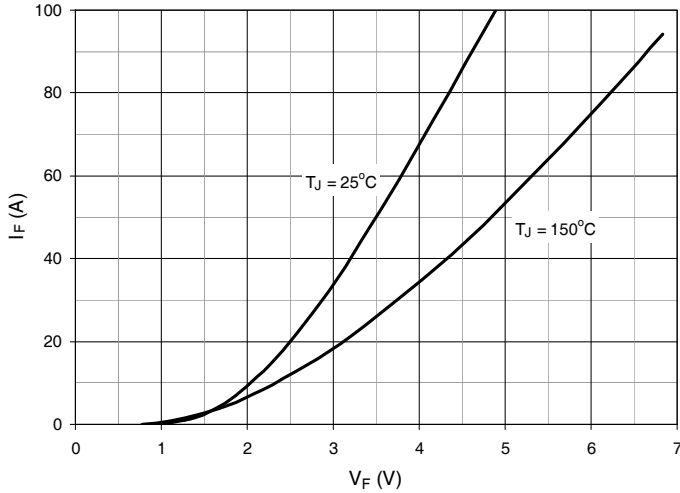

Fig. 22. Reverse Recovery Charge vs.  $-di_F/dt$

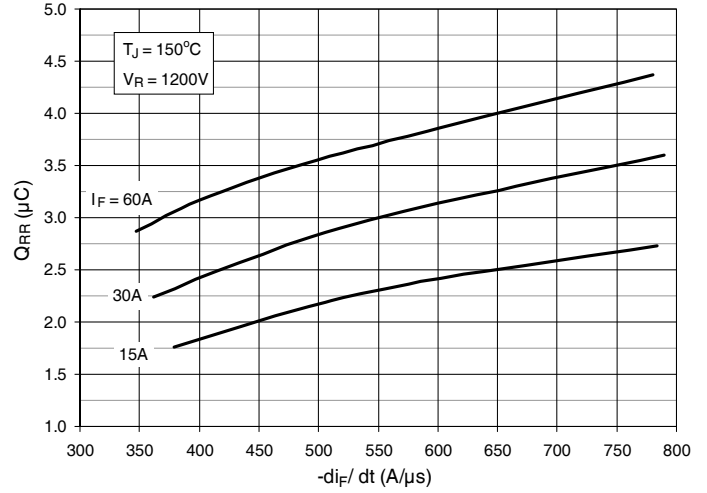

Fig. 23. Reverse Recovery Current vs.  $-di_F/dt$

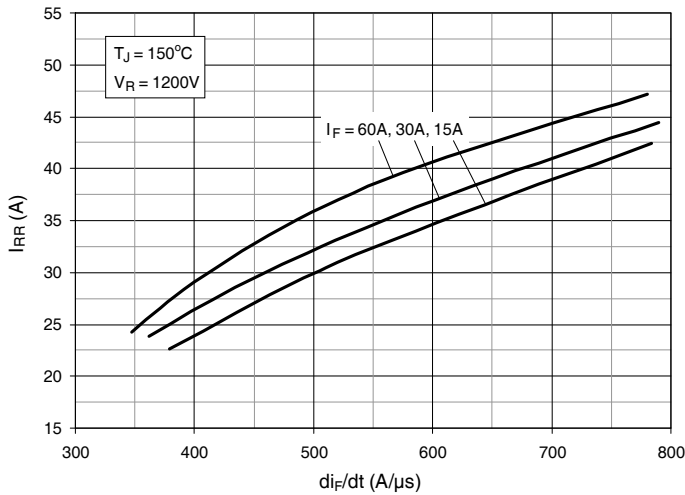

Fig. 24. Reverse Recovery Time vs.  $-di_F/dt$

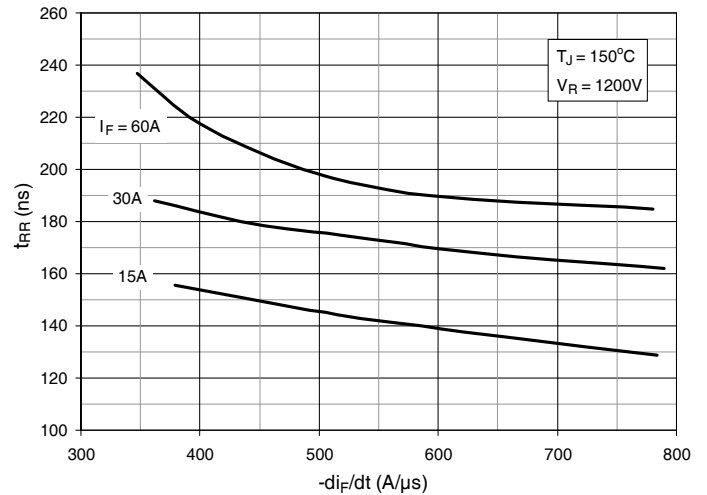

Fig. 25. Dynamic Parameters  $Q_{RR}$ ,  $I_{RR}$  vs. Junction Temperature

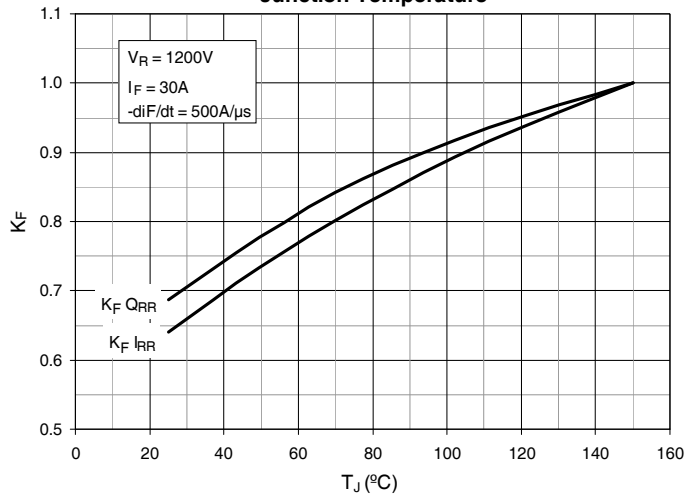
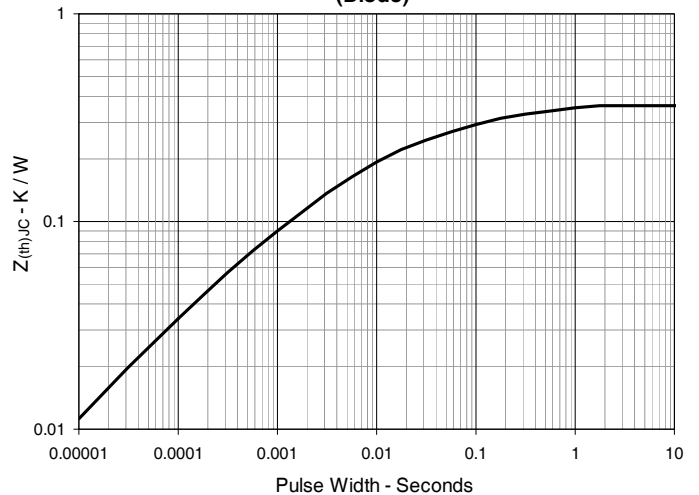

Fig. 26. Maximum Transient Thermal Impedance (Diode)





---

Disclaimer Notice - Information furnished is believed to be accurate and reliable. However, users should independently evaluate the suitability of and test each product selected for their own applications. Littelfuse products are not designed for, and may not be used in, all applications. Read complete Disclaimer Notice at [www.littelfuse.com/disclaimer-electronics](http://www.littelfuse.com/disclaimer-electronics).