

TP6KE Series

Axial Leaded – 600W

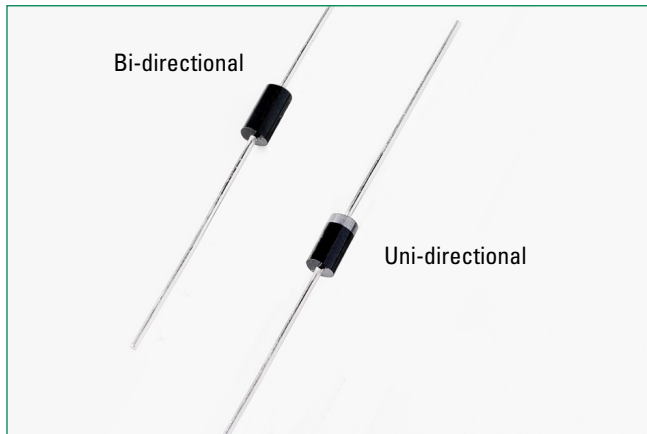

Additional Information



Resources



Accessories



Samples

Agency Approvals

Agency	Agency File Number
	E230531

Maximum Ratings and Thermal Characteristics

($T_A=25^\circ\text{C}$ unless otherwise noted)

Parameter	Symbol	Value	Unit
Peak Pulse Power Dissipation by 10/1000 μs Test Waveform (Fig.2) (Note 1)	P_{PPM}	600	W
Steady State Power Dissipation on Infinite Heat Sink at $T_L=75^\circ\text{C}$ (Fig. 6)	P_D	5.0	W
Peak Forward Surge Current, 8.3ms Single Half Sine Wave Unidirectional Only (Note 2)	I_{FSM}	100	A
Maximum Instantaneous Forward Voltage at 50A for Unidirectional Only	V_F	3.5	V
Operating Junction and Storage Temperature Range	T_J, T_{STG}	-55 to 175	$^\circ\text{C}$
Typical Thermal Resistance Junction to Lead	R_{uJL}	20	$^\circ\text{C}/\text{W}$
Typical Thermal Resistance Junction to Ambient	R_{uJA}	75	$^\circ\text{C}/\text{W}$

Notes:

- Non-repetitive current pulse, per Fig. 4 and derated above T_J (initial) = 25°C per Fig. 3.
- Measured on 8.3ms single half sine wave or equivalent square wave, duty cycle=4 per minute maximum.

Description

The AEC-Q101 qualified TP6KE Series is designed specifically to protect sensitive electronic equipment from voltage transients induced by lightning and other transient voltage events.

Features & Benefits

- Hi reliability application and automotive grade AEC-Q101 qualified
- Glass passivated chip junction in DO-15 Package
- 600W peak pulse capability at 10/1000 μs waveform, repetition rate (duty cycles):0.01%
- Fast response time: typically less than 1.0ps from 0 Volts to BV min
- Excellent clamping capability
- Typical failure mode is short from over-specified voltage or current
- Whisker test is conducted based on JEDEC JESD201A per its table 4a and 4c
- IEC-61000-4-2 ESD 30kV(Air), 30kV (Contact)
- ESD protection of data lines in accordance with IEC 61000-4-2 (IEC801-2)
- EFT protection of data lines in accordance with IEC 61000-4-4 (IEC801-4)
- Low incremental surge resistance
- High temperature to reflow soldering guaranteed: 260 $^\circ\text{C}$ /40sec / 0.375"/(9.5mm) lead length, 5 lbs., (2.3kg) tension
- $VBR @ T_J = VBR @ 25^\circ\text{C} \times (1 + \alpha_T \times (T_J - 25))$ (α_T : Temperature Coefficient, typical value is 0.1%)
- Plastic package has underwriters laboratory flammability classification 94V-0
- Lead-free matte tin plated package
- Halogen free and RoHS compliant

Applications

TVS devices are ideal for the protection of I/O interfaces, VCC bus and other vulnerable circuits used in telecom, computer, industrial and consumer electronic applications.

Functional Diagram

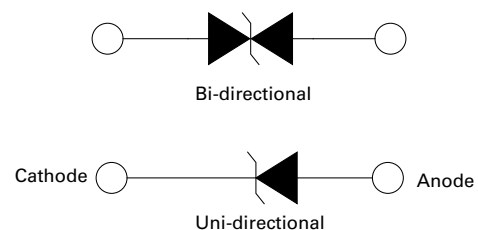

TP6KE Series

Axial Leaded – 600W

Electrical Characteristics ($T_A=25^\circ\text{C}$ unless otherwise noted)

Part Number (Uni)	Part Number (Bi)	Reverse Stand off Voltage V_R (Volts)	Breakdown Voltage V_{BR} (Volts) @ I_T		Test Current I_T (mA)	Maximum Clamping Voltage V_C @ I_{PP} (V)	Maximum Peak Pulse Current I_{PP} (A)	Maximum Reverse Leakage I_R @ V_R (μA)	Agency Approval
			MIN	MAX					
TP6KE13A	TP6KE13CA	11.10	12.40	13.70	1	18.2	33.5	1	X
TP6KE15A	TP6KE15CA	12.80	14.30	15.80	1	21.2	28.8	1	X
TP6KE16A	TP6KE16CA	13.60	15.20	16.80	1	22.5	27.1	1	X
TP6KE18A	TP6KE18CA	15.30	17.10	18.90	1	25.2	24.2	1	X
TP6KE20A	TP6KE20CA	17.10	19.00	21.00	1	27.7	22.0	1	X
TP6KE22A	TP6KE22CA	18.80	20.90	23.10	1	30.6	19.9	1	X
TP6KE24A	TP6KE24CA	20.50	22.80	25.20	1	33.2	18.4	1	X
TP6KE27A	TP6KE27CA	23.10	25.70	28.40	1	37.5	16.3	1	X
TP6KE30A	TP6KE30CA	25.60	28.50	31.50	1	41.4	14.7	1	X
TP6KE33A	TP6KE33CA	28.20	31.40	34.70	1	45.7	13.3	1	X
TP6KE36A	TP6KE36CA	30.80	34.20	37.80	1	49.9	12.2	1	X
TP6KE39A	TP6KE39CA	33.30	37.10	41.00	1	53.9	11.3	1	X
TP6KE43A	TP6KE43CA	36.80	40.90	45.20	1	59.3	10.3	1	X
TP6KE47A	TP6KE47CA	40.20	44.70	49.40	1	64.8	9.4	1	X
TP6KE51A	TP6KE51CA	43.60	48.50	53.60	1	70.1	8.7	1	X
TP6KE56A	TP6KE56CA	47.80	53.20	58.80	1	77.0	7.9	1	X
TP6KE62A	TP6KE62CA	53.00	58.90	65.10	1	85.0	7.2	1	X
TP6KE68A	TP6KE68CA	58.10	64.60	71.40	1	92.0	6.6	1	X
TP6KE75A	TP6KE75CA	64.10	71.30	78.80	1	103.0	5.9	1	X
TP6KE82A	TP6KE82CA	70.10	77.90	86.10	1	113.0	5.4	1	X
TP6KE91A	TP6KE91CA	77.80	86.50	95.50	1	125.0	4.9	1	X

For parts without A, the V_{BR} is $\pm 10\%$ and V_C is 5% higher than with A parts

I-V Curve Characteristics

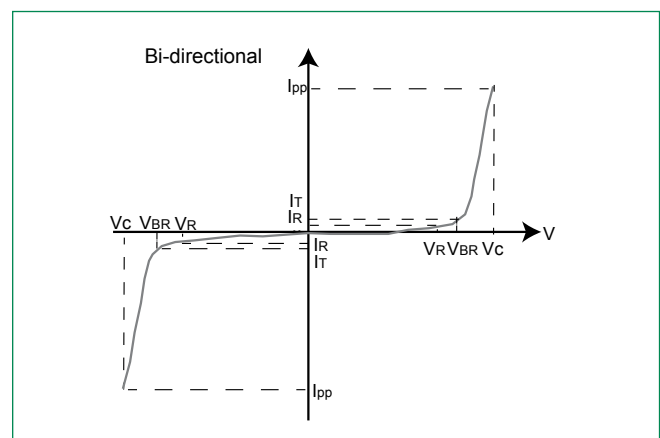
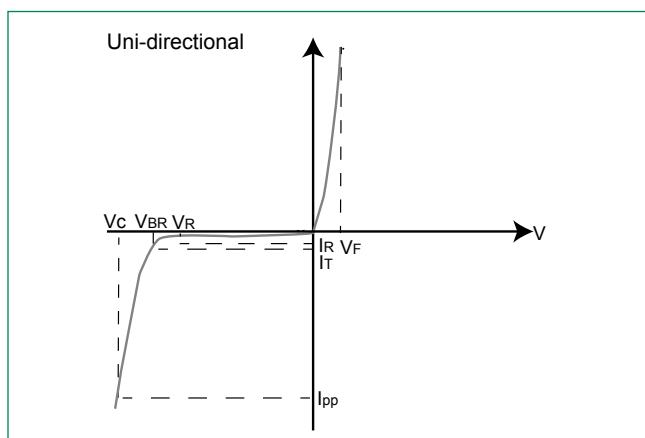

P_{PPM} Peak Pulse Power Dissipation -- Max power dissipation
 V_R Stand-off Voltage -- Maximum voltage that can be applied to the TVS without operation
 V_{BR} Breakdown Voltage -- Maximum voltage that flows through the TVS at a specified test current (I_T)
 V_C Clamping Voltage -- Peak voltage measured across the TVS at a specified I_{PPM} (peak impulse current)
 I_R Reverse Leakage Current -- Current measured at V_R
 V_F Forward Voltage Drop for Uni-directional

TP6KE Series

Axial Leaded – 600W

Ratings and Characteristic Curves ($T_A=25^\circ\text{C}$ unless otherwise noted)

Figure 1 -
TVS Transients Clamping Waveform

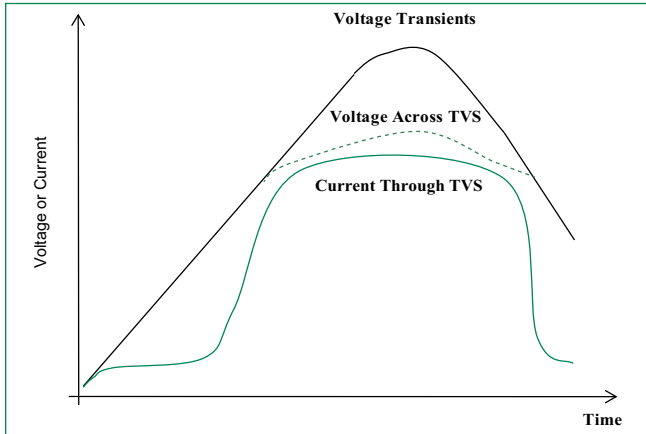

Figure 2 -
Peak Pulse Power Rating

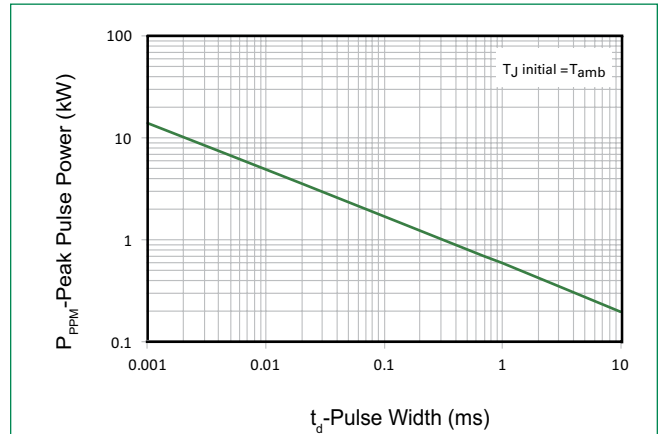

Figure 3 -
Peak Pulse Power Derating Curve

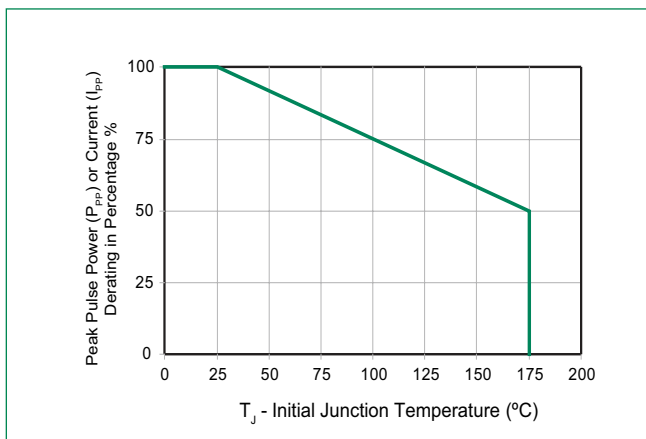

Figure 4 -
Pulse Waveform

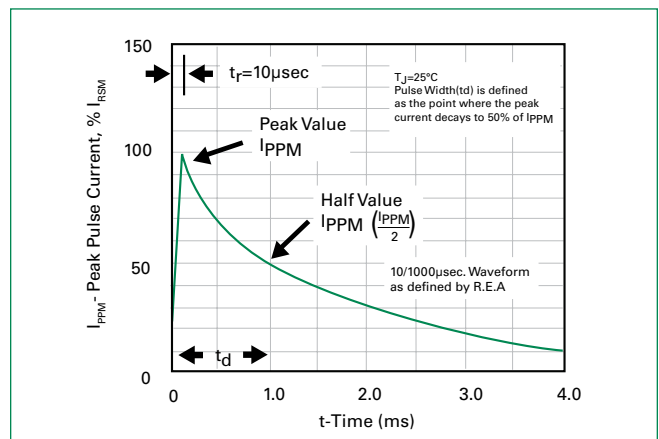

Figure 5 -
Typical Junction Capacitance

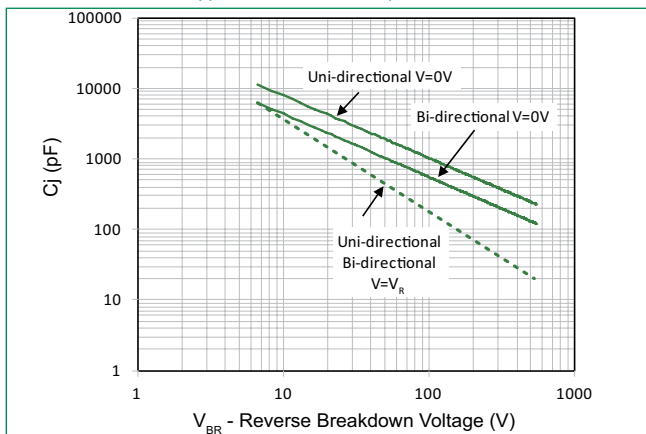
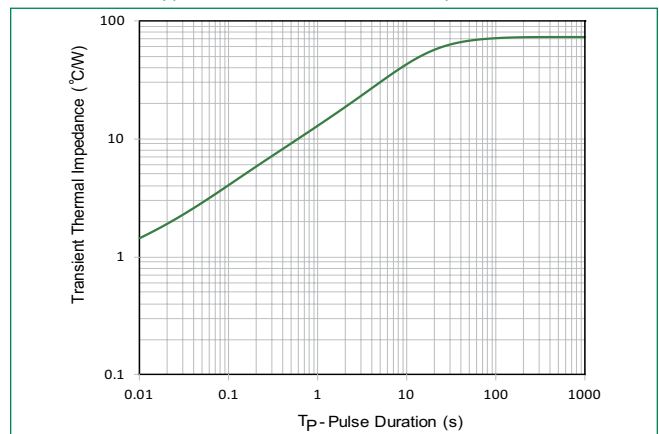

Figure 6 -
Typical Transient Thermal Impedance



TP6KE Series

Axial Leaded – 600W

Figure 7 -
Maximum Non-Repetitive Peak Forward Surge Current
Uni-Directional Only

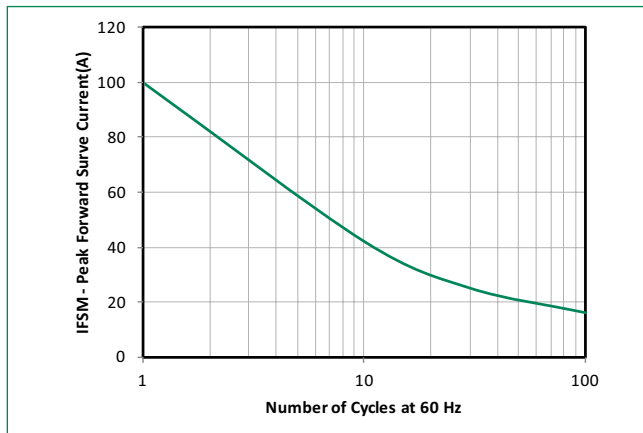

Flow/Wave Soldering (Solder Dipping)

Peak Temperature :	265°C
Dipping Time :	10 seconds
Soldering :	1 time

Physical Specificationst

Weight	0.015oz., 0.4g
Case	JEDEC DO-204AC (DO-15) molded plastic body over passivated junction.
Polarity	Color band denotes the cathode except Bipolar.
Terminal	Matte Tin axial leads, solderable per JESD22-B102.

Environmental Specifications

High Temp. Storage	JESD22-A103
HTRB	JESD22-A108
Temperature Cycling	JESD22-A104
H3TRB	JESD22-A101
RSH	JESD22-B106

Dimensions

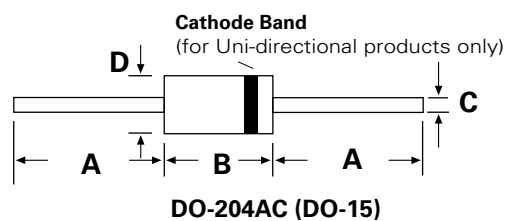

Dimensions	Inches		Millimeters	
	Min	Max	Min	Max
A	1.000	-	25.40	-
B	0.230	0.300	5.80	7.60
C	0.028	0.034	0.71	0.86
D	0.104	0.140	2.60	3.60

TP6KE Series

Axial Leaded – 600W

Part Numbering System

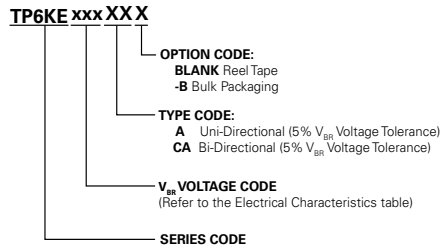

Part Marking System

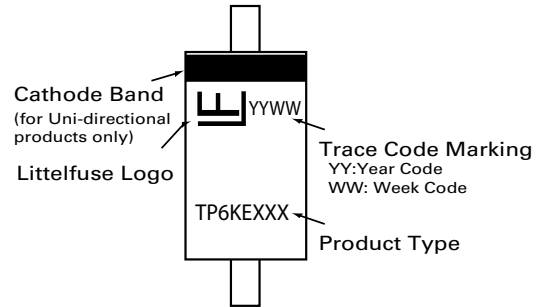

Packaging

Part Number	Component Package	Quantity	Packaging Option	Packaging Specification
TP6KExxxXX	DO-15 (DO-204AC)	4000	Tape & Reel	EIA STD RS-296
TP6KExxxXX-B	DO-15 (DO-204AC)	1000	BULK	Littelfuse Spec.

Tape and Reel Specification

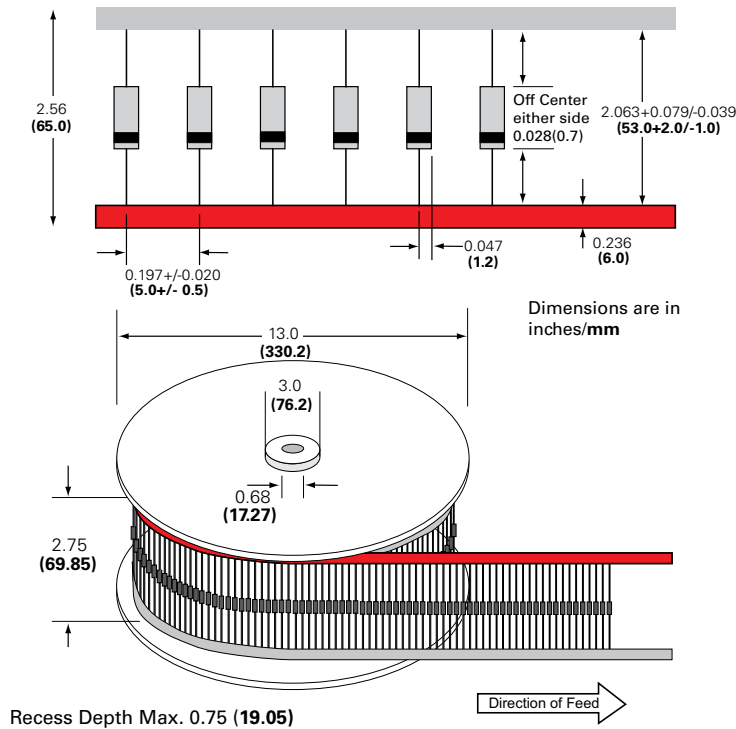

Disclaimer Notice - Information furnished is believed to be accurate and reliable. However, users should independently evaluate the suitability of and test each product selected for their own applications. Littelfuse products are not designed for, and may not be used in, all applications. Read complete Disclaimer Notice at <http://www.littelfuse.com/disclaimer-electronics>.