

TP5KP Series

Axial Leaded – 5 kW

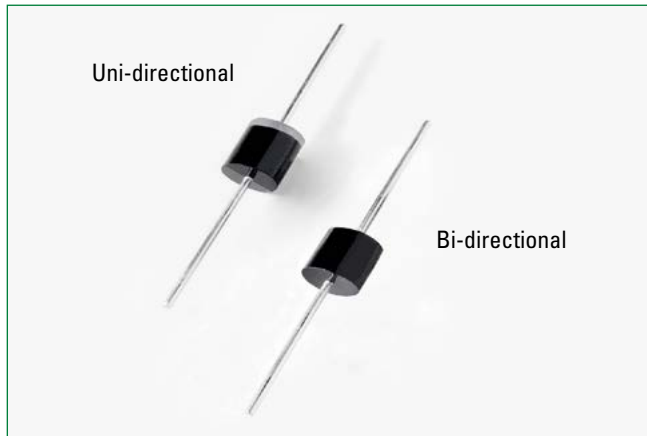

Web Resources



Download ECAD models, order samples, and find technical resources at www.littelfuse.com

Agency Approvals

Agency	Agency File Number
	E230531

Maximum Ratings and Thermal Characteristics ($T_A = 25^\circ\text{C}$ unless otherwise noted)

Parameter	Symbol	Value	Unit
Peak Pulse Power Dissipation by 10/1000 μs Test Waveform (Fig.2)(Note 1)	P_{PPM}	5000	W
Steady State Power Dissipation on Infinite Heat Sink at $T_J = 75^\circ\text{C}$	P_D	8.0	W
Peak Forward Surge Current, 8.3ms Single Half Sine Wave Unidirectional Only (Note 2)	I_{FSM}	400	A
Maximum Instantaneous Forward Voltage at 100A for Unidirectional Only (Note 3)	V_F	3.5	V
Operating Junction Temperature Range	T_J	-55 to 150	$^\circ\text{C}$
Storage Temperature Range	T_{STG}	-55 to 175	$^\circ\text{C}$
Typical Thermal Resistance Junction to Lead	$R_{\theta JL}$	8.0	$^\circ\text{C}/\text{W}$
Typical Thermal Resistance Junction to Ambient	$R_{\theta JA}$	40	$^\circ\text{C}/\text{W}$

Notes:

- Non-repetitive current pulse, per Fig. 4 and derated above T_J (initial) $= 25^\circ\text{C}$ per Fig. 3.
- Measured on 8.3ms single half sine wave or equivalent square wave, duty cycle=4 per minute maximum.



Description

The TP5KP Series is designed specifically to protect sensitive electronic equipment from voltage transients induced by lightning and other transient voltage events.

Features & Benefits

- Hi reliability application and automotive grade AEC Q101 qualified
- Glass passivated chip junction in P600 package
- 5000W peak pulse capability at 10/1000 μs waveform, repetition rate (duty cycles):0.01%
- Fast response time: typically less than 1.0ps from 0 Volts to BV min
- Excellent clamping capability
- Typical failure mode is short from over-specified voltage or current
- Whisker test is conducted based on JEDEC JESD201A per its table 4a and 4c
- IEC-61000-4-2 ESD 30kV(Air), 30kV (Contact)
- ESD protection of data lines in accordance with IEC 61000-4-2
- EFT protection of data lines in accordance with IEC 61000-4-4
- Low incremental surge resistance
- Typical I_R less than 2 μA when $V_{BR \text{ min}} > 12\text{V}$
- High temperature to reflow soldering guaranteed: 260 $^\circ\text{C}/10\text{sec} / 0.375''$, (9.5mm) lead length, 5 lbs., (2.3kg) tension
- $V_{BR} @ T_J = V_{BR} @ 25^\circ\text{C} \times (1 + \alpha T \times (T_J - 25))$ (αT : Temperature Coefficient, typical value is 0.1%)
- Plastic package is flammability rated V-0 per Underwriters Laboratories
- Matte tin lead-free plated
- Halogen free and RoHS compliant
- Pb-free E3 means 2nd level interconnect is Pb-free and the terminal finish material is tin(Sn) (IPC/JEDEC J-STD-609A.01)

Applications

TVS devices are ideal for the protection of I/O interfaces, V_{CC} bus and other vulnerable circuits used in telecom, computer, industrial and consumer electronic applications.

Functional Diagram

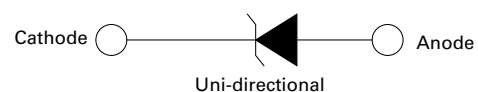
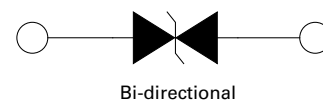

TP5KP Series

Axial Leaded – 5 kW

Electrical Characteristics ($T_A=25^\circ\text{C}$ unless otherwise noted)

Part Number (Uni)	Part Number (Bi)	Reverse Stand off Voltage V_R (Volts)	Breakdown Voltage V_{BR} (Volts) @ I_T		Test Current I_T (mA)	Maximum Clamping Voltage V_C @ I_{PP} (V)	Maximum Peak Pulse Current I_{PP} (A)	Maximum Reverse Leakage I_R @ V_R (μA)	Agency Approval
			MIN	MAX					
TP5KP11A	TP5KP11CA	11.0	12.20	13.50	5	18.2	280.2	2	X
TP5KP12A	TP5KP12CA	12.0	13.30	14.70	5	19.9	256.3	2	X
TP5KP13A	TP5KP13CA	13.0	14.40	15.90	5	21.5	237.2	2	X
TP5KP14A	TP5KP14CA	14.0	15.60	17.20	5	23.2	219.8	2	X
TP5KP15A	TP5KP15CA	15.0	16.70	18.50	5	24.4	209.0	2	X
TP5KP16A	TP5KP16CA	16.0	17.80	19.70	5	26.0	196.2	2	X
TP5KP17A	TP5KP17CA	17.0	18.90	20.90	5	27.6	184.8	2	X
TP5KP18A	TP5KP18CA	18.0	20.00	22.10	5	29.2	174.7	2	X
TP5KP20A	TP5KP20CA	20.0	22.20	24.50	5	32.4	157.4	2	X
TP5KP22A	TP5KP22CA	22.0	24.00	26.90	5	35.5	143.7	2	X
TP5KP24A	TP5KP24CA	24.0	26.70	29.50	5	38.9	131.1	2	X
TP5KP26A	TP5KP26CA	26.0	28.90	31.90	5	42.1	121.1	2	X
TP5KP28A	TP5KP28CA	28.0	31.10	34.40	5	45.4	112.3	2	X
TP5KP30A	TP5KP30CA	30.0	33.30	36.80	5	48.4	105.4	2	X
TP5KP33A	TP5KP33CA	33.0	36.70	40.60	5	53.3	95.7	2	X
TP5KP36A	TP5KP36CA	36.0	40.00	44.20	5	58.1	87.8	2	X
TP5KP40A	TP5KP40CA	40.0	44.40	49.10	5	64.5	79.1	2	X
TP5KP43A	TP5KP43CA	43.0	47.80	52.80	5	69.4	73.5	2	X
TP5KP45A	TP5KP45CA	45.0	50.00	55.30	5	72.7	70.2	2	X
TP5KP48A	TP5KP48CA	48.0	53.30	58.90	5	77.4	65.9	2	X
TP5KP51A	TP5KP51CA	51.0	56.70	62.70	5	82.4	61.9	2	X
TP5KP54A	TP5KP54CA	54.0	60.00	66.30	5	87.1	58.6	2	X
TP5KP58A	TP5KP58CA	58.0	64.40	71.20	5	93.6	54.5	2	X
TP5KP60A	TP5KP60CA	60.0	66.70	73.70	5	96.8	52.7	2	X
-	TP5KP64CA	64.0	71.1	78.6	5	103.0	49.5	2	X

I-V Curve Characteristics

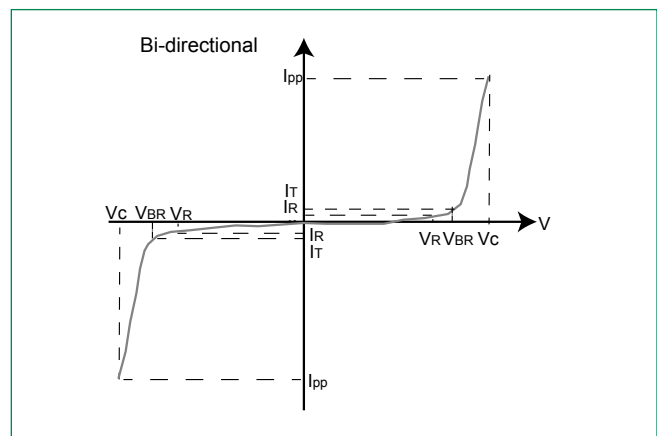
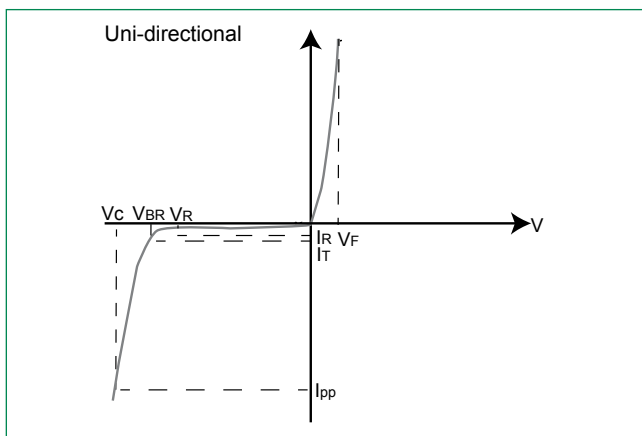

P_{PPM} Peak Pulse Power Dissipation -- Max power dissipation
 V_R Stand-off Voltage -- Maximum voltage that can be applied to the TVS without operation
 V_{BR} Breakdown Voltage -- Maximum voltage that flows though the TVS at a specified test current (I_T)
 V_C Clamping Voltage -- Peak voltage measured across the TVS at a specified I_{PPM} (peak impulse current)
 I_R Reverse Leakage Current -- Current measured at V_R
 V_F Forward Voltage Drop for Uni-directional

TP5KP Series

Axial Leaded – 5 kW

Ratings and Characteristic Curves ($T_A=25^\circ\text{C}$ unless otherwise noted)

Figure 1 - TVS Transients Clamping Waveform

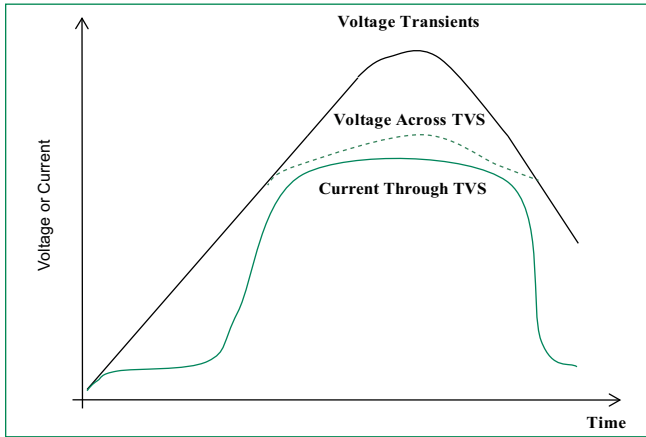

Figure 2 - Peak Pulse Power Rating Curve

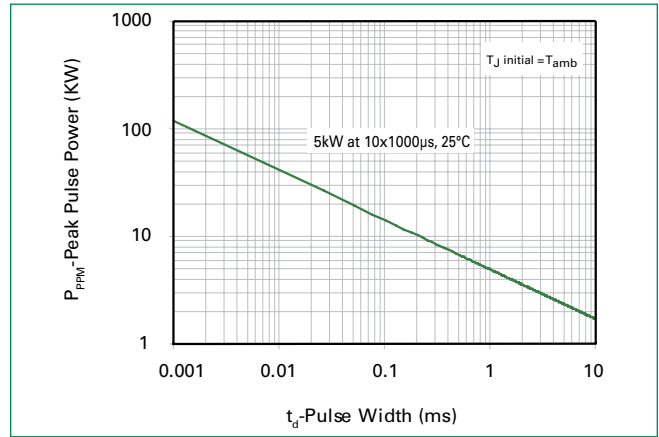

Figure 3 - Peak Pulse Power Derating Curve

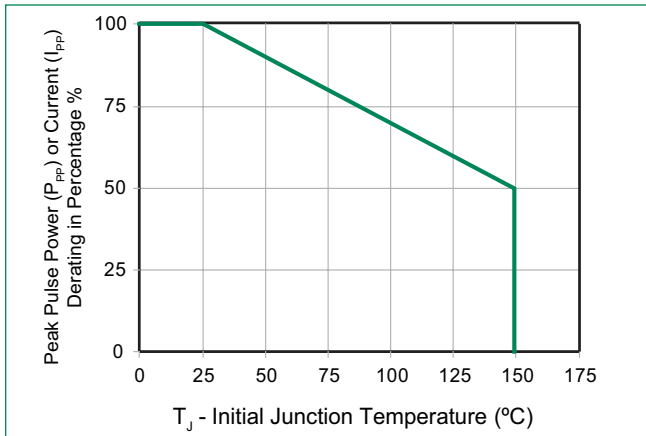

Figure 4 - Pulse Waveform

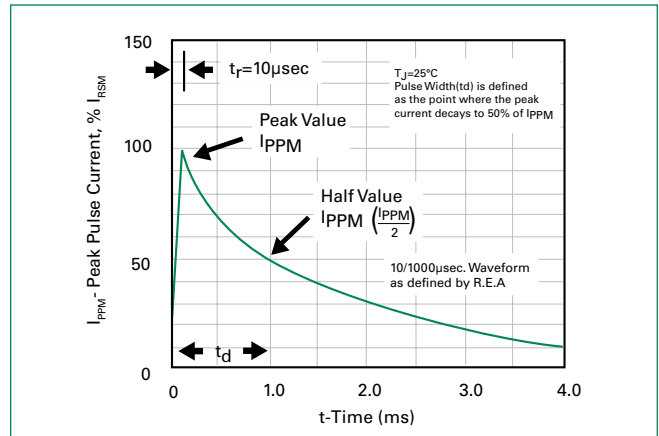

Figure 5 - Typical Junction Capacitance

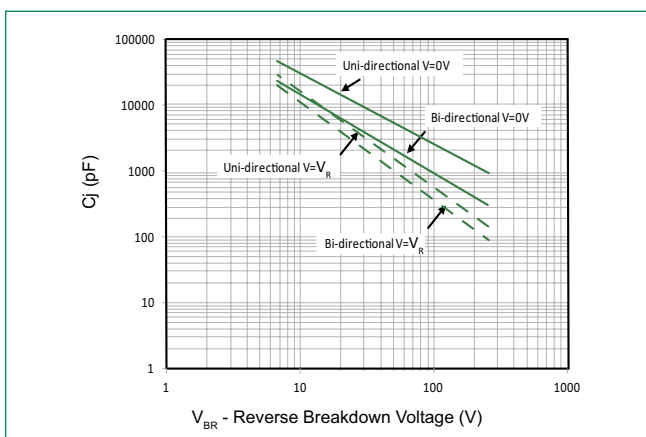
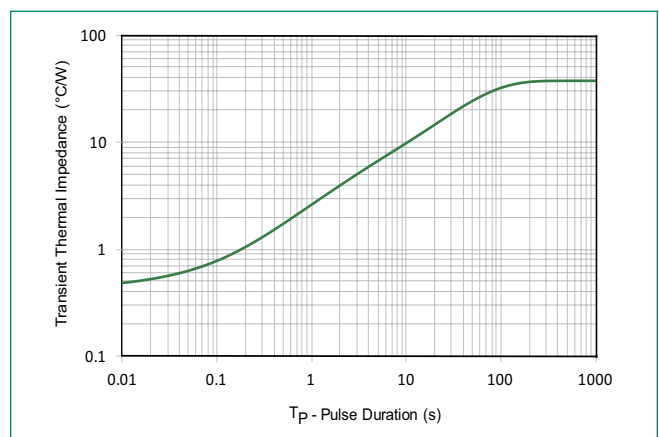

Figure 6 - Typical Transient Thermal Impedance



TP5KP Series

Axial Leaded – 5 kW

Figure 7 - Maximum Non-Repetitive Peak Forward Surge Current Uni-Directional Only

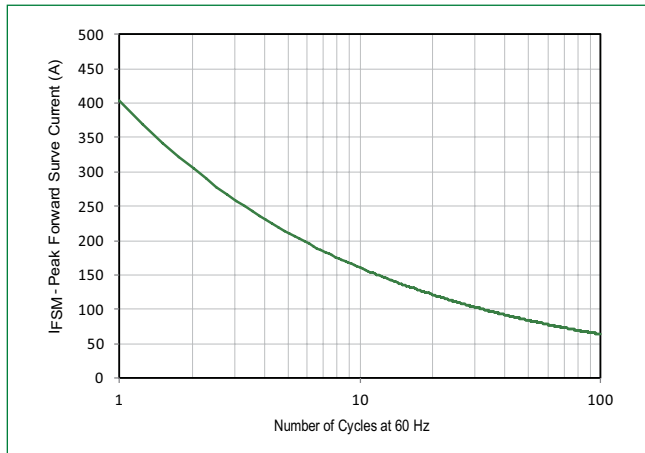
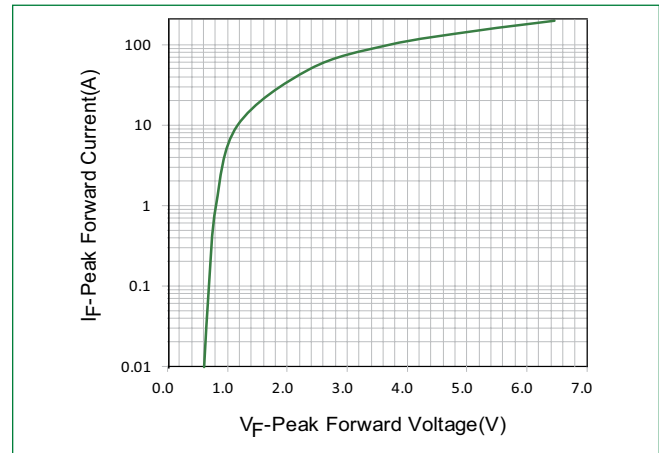
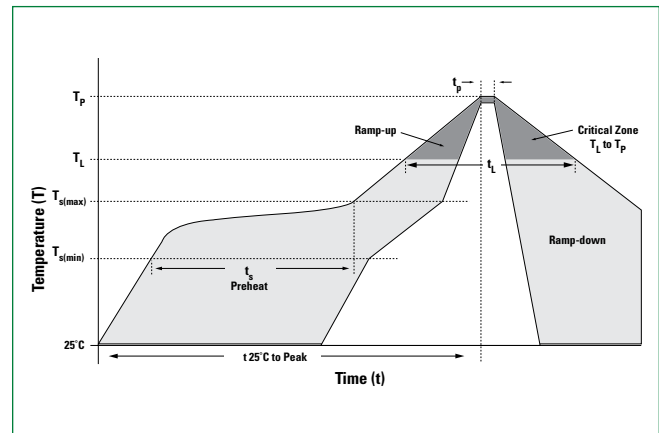

Figure 8 - Peak Forward Voltage Drop vs Peak Forward Current (Typical Values)



Soldering Parameters

Reflow Condition	Lead-free assembly	
Pre Heat	- Temperature Min ($T_{s(min)}$)	150°C
	- Temperature Max ($T_{s(max)}$)	200°C
	- Time (min to max) (t_s)	60 - 120 secs
Average ramp up rate (Liquidus Temp (T_A) to peak)	3°C/second max	
$T_{s(max)}$ to T_A - Ramp-up Rate	3°C/second max	
Reflow	- Temperature (T_A) (Liquidus)	217°C
	- Time (min to max) (t_s)	60 – 150 seconds
Peak Temperature (T_p)	260 ^{+0/-5} °C	
Time within 5°C of actual peak Temperature (t_p)	30 seconds	
Ramp-down Rate	6°C/second max	
Time 25°C to peak Temperature (T_p)	8 minutes Max.	
Do not exceed	260°C	



Physical Specifications

Weight	0.07oz., 2.1g
Case	P600 molded plastic body over passivated junction.
Polarity	Color band denotes the cathode except Bipolar.
Terminal	Matte Tin axial leads, solderable per JESD22-B102.

Flow/Wave Soldering (Solder Dipping)

Peak Temperature :	265°C
Dipping Time :	10 seconds
Soldering :	1 time

Environmental Specifications

High Temp. Storage	JESD22-A103
HTRB	JESD22-A108
Temperature Cycling	JESD22-A104
H3TRB	JESD22-A101
RSH	JESD22-B106

TP5KP Series

Axial Leaded – 5 kW

Dimensions

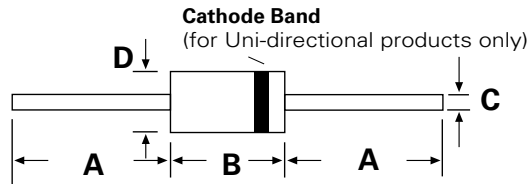

Dimensions	Inches		Millimeters	
	Min	Max	Min	Max
A	1.000	-	25.40	-
B	0.340	0.360	8.60	9.10
C	0.048	0.052	1.22	1.32
D	0.340	0.360	8.60	9.10

P600

Part Numbering System

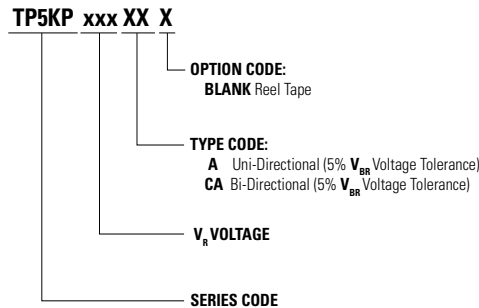

Part Marking System

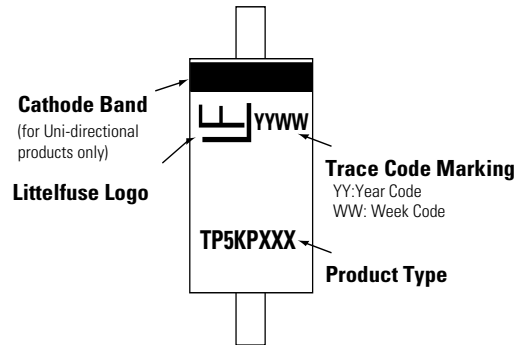

Packing Options

Part Number	Component Package	Quantity	Packaging Option	Packaging Specification
TP5KPxxxXX	P600	800	Tape & Reel	EIA STD RS-296

Tape and Reel Specification

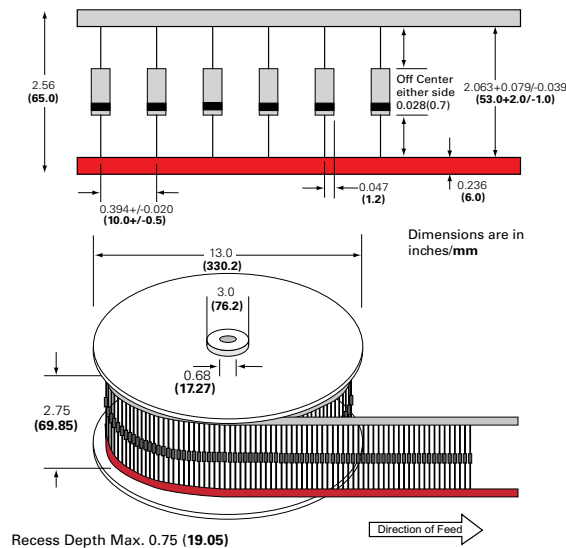

Disclaimer Notice - Information furnished is believed to be accurate and reliable. However, users should independently evaluate the suitability of and test each product selected for their own applications. Littelfuse products are not designed for, and may not be used in, all applications. Read complete Disclaimer Notice at <http://www.littelfuse.com/disclaimer-electronics>.