

# SZ1SMA Series

## Surface Mount > 400W



### Web Resources



Download ECAD models, order samples, and find technical resources at [www.littelfuse.com](http://www.littelfuse.com)

### Agency Approvals

Agency	Agency File Number
	E128662

### Maximum Ratings and Thermal Characteristics

Parameter	Symbol	Value	Unit
Peak Power Dissipation (Note 1) @ $T_L = 25^\circ\text{C}$ , Pulse Width = 1 ms	$P_{PK}$	400	W
DC Power Dissipation @ $T_L = 75^\circ\text{C}$ Measured Zero Lead Length (Note 2) Derate Above $75^\circ\text{C}$ Thermal Resistance from Junction-to-Lead	$P_D$	2.0	W
	$R_{\theta JL}$	20	mW/°C
DC Power Dissipation (Note 3) @ $T_A = 25^\circ\text{C}$ Derate Above $25^\circ\text{C}$ Thermal Resistance from Junction-to-Ambient	$P_D$	1.2	W
	$R_{\theta JA}$	8.3	mW/°C
Forward Surge Current (Note 4) @ $T_A = 25^\circ\text{C}$ (for uni-directional)	$I_{FSM}$	40	A
Operating and Storage Temperature Range	$T_J$	-65 to	°C
	$T_{stg}$	+175	

Stresses exceeding those listed in the Maximum Ratings table may damage the device. If any of these limits are exceeded, device functionality should not be assumed, damage may occur and reliability may be affected.

- 10 X 1000  $\mu\text{s}$ , non-repetitive.
- 1" square copper pad, FR-4 board.
- FR-4 board, using Littelfuse minimum recommended footprint
- 1/2 sine wave (or equivalent square wave), PW = 8.3 ms, duty cycle = 4 pulses per minute maximum. (for uni-directional)

### Description

The SZ1SMA series is designed to protect voltage sensitive components from high voltage, high energy transients. They have excellent clamping capability, high surge capability, low zener impedance and fast response time. The SZ1SMA series is supplied in cost-effective, highly reliable DO-214AC package and it is ideal for use in automotive electronic applications.

### Features & Benefits

- Zener Transient Overvoltage Suppressors
- Working Peak Reverse Voltage Range -5V to 170V for uni-directional and 10 V to 78 V for bi-directional
- Standard Zener Breakdown Voltage Range -11.1 V to 95.83 V for bi-directional, 6.4 V to 209 V for uni-directional
- Peak Power - 400 W @ 1 ms
- ESD protection of data lines in accordance with IEC 61000-4-2 30kV(Air), 30kV (Contact)
- ESD Rating of Class 3 (> 16 kV) per Human Body Model
- Response Time is Typically < 1 ns
- Flat Handling Surface for Accurate Placement
- Package Design for Top Slide or Bottom Circuit
- $V_{BR} @ T_J = V_{BR} @ 25^\circ\text{C} \times (1 + \alpha_T \times (T_J - 25))$  ( $\alpha_T$ : Temperature Coefficient)
- Board Mounting
- Low Profile Package
- Pb-free means 2nd level interconnect is Pb-free and the terminal finish material is tin(Sn) (IPC/JEDEC J-STD-609A.01)
- SZ Prefix for Automotive and Other Applications Requiring Unique Site and Control Change Requirements; AEC-Q101 Qualified and PPAP Capable
- Recognized to UL 497B as an Isolated Loop Circuit Protector
- RoHS-compliant and halogen-free

### Functional Diagram

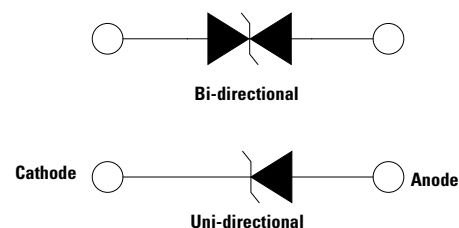

# SZ1SMA Series

## Surface Mount > 400W

### I-V Curve Characteristics ( $T_A = 25^\circ\text{C}$ unless otherwise noted) – For Bi-directional

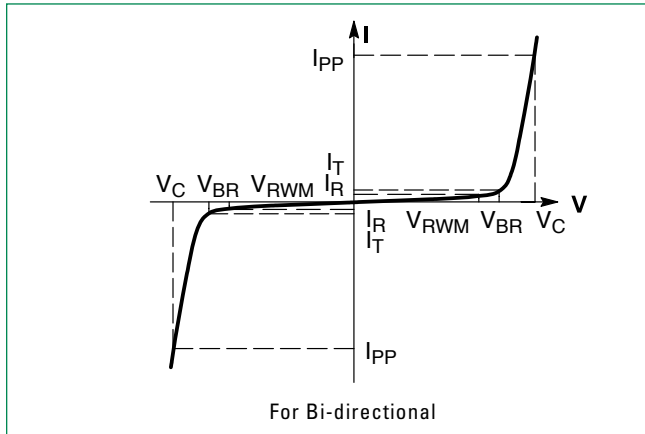

Symbol	Parameter
$I_{PP}$	Maximum Reverse Peak Pulse Current
$V_C$	Clamping Voltage @ $I_{PP}$
$V_{RWM}$	Working Peak Reverse Voltage
$I_R$	Maximum Reverse Leakage Current @ $V_{RWM}$
$V_{BR}$	Breakdown Voltage @ $I_T$
$I_T$	Test Current

### I-V Curve Characteristics ( $T_A = 25^\circ\text{C}$ unless otherwise noted, $V_F = 3.5\text{V Max.}$ @ $I_F = 30\text{A}$ for all types) (Note 5) – For Uni-directional

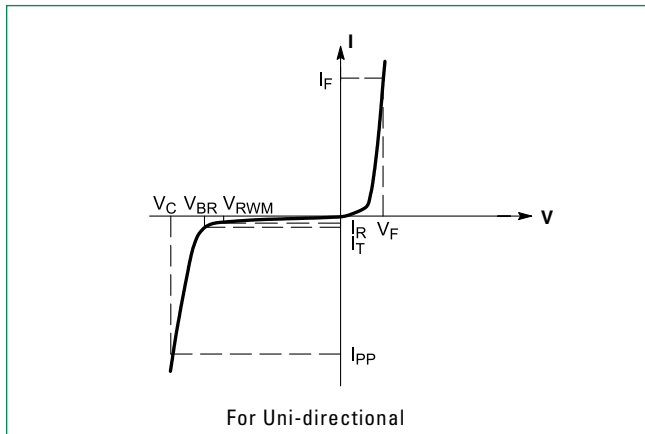

Symbol	Parameter
$I_{PP}$	Maximum Reverse Peak Pulse Current
$V_C$	Clamping Voltage @ $I_{PP}$
$V_{RWM}$	Working Peak Reverse Voltage
$I_R$	Maximum Reverse Leakage Current @ $V_{RWM}$
$V_{BR}$	Breakdown Voltage @ $I_T$
$I_T$	Test Current
$I_F$	Forward Current
$V_F$	Forward Voltage @ $I_F$

5. 1/2 sine wave or equivalent, PW = 8.3 ms, non-repetitive duty cycle.

# SZ1SMA Series

## Surface Mount > 400W

### Electrical Characteristics – For Uni-directional

Device	Device Marking	$V_{RWM}$ <sup>Note 6</sup>	$I_R$ @ $V_{RWM}$	Breakdown Voltage				$V_C$ @ $I_{PP}$ <sup>Note 8</sup>		C Typ. <sup>Note 9</sup>	Agency Approval
				$V_{BR}$ @ $I_T$ (V) <sup>Note 7</sup>			@ $I_T$	$V_C$	$I_{PP}$		
				MIN	NOM	MAX					
SZ1SMA5.0AT3G	QE	5.0	400	6.40	6.70	7.00	10	9.2	43.5	2035	X
SZ1SMA6.0AT3G	QG	6.0	400	6.67	7.02	7.37	10	10.3	38.8	1730	X
SZ1SMA6.5AT3G	QK	6.5	250	7.22	7.60	7.98	10	11.2	35.7	1605	X
SZ1SMA8.0AT3G	QR	8.0	25	8.89	9.36	9.83	1	13.6	29.4	1035	X
SZ1SMA8.5AT3G	QT	8.5	5.0	9.44	9.92	10.40	1	14.4	27.8	1265	X
SZ1SMA9.0AT3G	QV	9.0	2.5	10.00	10.55	11.10	1	15.4	26.0	1200	X
SZ1SMA10AT3G	QX	10	2.5	11.10	11.70	12.30	1	17.0	23.5	1090	X
SZ1SMA11AT3G	OZ	11	2.5	12.20	12.85	13.50	1	18.2	22.0	1000	X
SZ1SMA12AT3G	RE	12	2.5	13.30	14.00	14.70	1	19.9	20.1	925	X
SZ1SMA13AT3G	RG	13	2.5	14.40	15.15	15.90	1	21.5	18.6	860	X
SZ1SMA14AT3G	RH	14	2.5	15.60	16.40	17.20	1	23.2	17.2	800	X
SZ1SMA15AT3G	RM	15	2.5	16.70	17.60	18.50	1	24.4	16.4	758	X
SZ1SMA16AT3G	RP	16	2.5	17.80	18.75	19.70	1	26.0	15.4	715	X
SZ1SMA17AT3G	RR	17	2.5	18.90	19.90	20.90	1	27.6	14.5	680	X
SZ1SMA18AT3G	RT	18	2.5	20.00	21.05	22.10	1	29.2	13.7	645	X
SZ1SMA20AT3G	RV	20	2.5	22.20	23.35	24.50	1	32.4	12.3	585	X
SZ1SMA22AT3G	RX	22	2.5	24.40	25.65	26.90	1	35.5	11.3	540	X
SZ1SMA24AT3G	RZ	24	2.5	26.70	28.10	29.50	1	38.9	10.3	500	X
SZ1SMA26AT3G	SE	26	2.5	28.90	30.40	31.90	1	42.1	9.5	460	X
SZ1SMA28AT3G	SG	28	2.5	31.10	32.75	34.40	1	45.4	8.8	430	X
SZ1SMA30AT3G	SK	30	1.0	33.30	35.05	36.80	1	48.4	8.3	405	X
SZ1SMA33AT3G	SM	33	2.5	36.70	38.65	40.60	1	53.3	7.5	375	X
SZ1SMA36AT3G	SP	36	2.5	40.00	42.10	44.20	1	58.1	6.9	345	X
SZ1SMA40AT3G	SR	40	2.5	44.40	46.75	49.10	1	64.5	6.2	315	X
SZ1SMA43AT3G	ST	43	2.5	47.80	50.30	52.80	1	69.4	5.8	295	X
SZ1SMA45AT3G	SV	45	2.5	50.00	52.65	55.30	1	72.2	5.5	280	X
SZ1SMA48AT3G	SX	48	2.5	53.30	56.10	58.90	1	77.4	5.2	265	X
SZ1SMA51AT3G	SZ	51	2.5	56.70	59.70	62.70	1	82.4	4.9	252	-
SZ1SMA54AT3G	TE	54	2.5	60.00	63.15	66.30	1	87.1	4.6	240	X
SZ1SMA58AT3G	TG	58	2.5	64.40	67.80	71.50	1	93.6	4.3	225	X
SZ1SMA60AT3G	TK	60	2.5	66.70	70.20	73.72	1	96.8	4.1	219	-
SZ1SMA70AT3G	TP	70	2.5	77.80	81.90	86.00	1	113.0	3.5	190	X
SZ1SMA75AT3G	TR	75	2.5	83.3	87.7	92.1	1	121.0	3.3	180	-
SZ1SMA78AT3G	TT	78	2.5	86.7	91.25	95.8	1	126.0	3.2	178	-
SZ1SMA85AT3G	TV	85	2.5	94.4	99.2	104	1	137.0	2.9	173	-
SZ1SMA90AT3G	TX	90	2.5	100	105.5	111	1	146.0	2.8	169	-
SZ1SMA100AT3G	TZ	100	2.5	111	117	123	1	162.0	2.5	162	-
SZ1SMA110AT3G	VE	110	2.5	122	128.5	135	1	177.0	2.3	155	-
SZ1SMA120AT3G	VG	120	2.5	133	140	147	1	193.0	2.1	148	-
SZ1SMA130AT3G	VK	130	2.5	144	151.5	159	1	209.0	1.9	142	-
SZ1SMA150AT3G	VM	150	2.5	167	176	185	1	243.0	1.7	127	-
SZ1SMA160AT3G	VP	160	2.5	178	187.5	197	1	259.0	1.6	119	-
SZ1SMA170AT3G	VR	170	2.5	189	199	209	1	275.0	1.5	112	-

# SZ1SMA Series

## Surface Mount > 400W

### Electrical Characteristics - For Bi-directional

Device	Device Marking	$V_{RWM}$ <sup>Note 6</sup>	$I_T @ V_{RWM}$	Breakdown Voltage			@ $I_T$	$V_C @ I_{PP}$ <sup>Note 8</sup>		Agency Approval
				$V_{BR} @ I_T$ (V) <sup>Note 7</sup>				$V_C$	$I_{PP}$	
				MIN	NOM	MAX				
SZ1SMA10CAT3G	QXC	10	2.5	11.10	11.69	12.27	1	17.0	23.5	X
SZ1SMA11CAT3G	QZC	11	2.5	12.20	12.85	13.50	1	18.2	22.0	-
SZ1SMA12CAT3G	REC	12	2.5	13.30	14.00	14.70	1	19.9	20.1	X
SZ1SMA13CAT3G	RGC	13	2.5	14.40	15.16	15.92	1	21.5	18.6	X
SZ1SMA14CAT3G	RHC	14	2.5	15.60	16.40	17.20	1	23.2	17.2	-
SZ1SMA15CAT3G	RMC	15	2.5	16.70	17.58	18.46	1	24.4	16.4	X
SZ1SMA16CAT3G	RPC	16	2.5	17.80	18.74	19.67	1	26.0	15.4	X
SZ1SMA17CAT3G	RRC	17	2.5	18.90	19.90	20.90	1	27.6	14.5	-
SZ1SMA18CAT3G	RTC	18	2.5	20.00	21.06	22.11	1	29.2	13.7	X
SZ1SMA20CAT3G	RVC	20	2.5	22.20	23.37	24.54	1	32.4	12.3	X
SZ1SMA22CAT3G	RXC	22	2.5	24.4	25.65	26.90	1	35.5	11.3	-
SZ1SMA24CAT3G	RZC	24	2.5	26.70	28.11	29.51	1	38.9	10.3	X
SZ1SMA26CAT3G	SEC	26	2.5	28.90	30.42	31.94	1	42.1	9.5	X
SZ1SMA28CAT3G	SGC	28	2.5	31.10	32.74	34.37	1	45.4	8.8	X
SZ1SMA30CAT3G	SKC	30	2.5	33.30	35.06	36.81	1	48.4	8.3	X
SZ1SMA33CAT3G	SMC	33	2.5	36.70	38.63	40.56	1	53.3	7.5	X
SZ1SMA36CAT3G	SPC	36	2.5	40.00	42.11	44.21	1	58.1	6.9	X
SZ1SMA40CAT3G	SRC	40	2.5	44.40	46.74	49.07	1	64.5	6.2	X
SZ1SMA43CAT3G	STC	43	2.5	47.80	50.30	52.80	1	69.4	5.8	-
SZ1SMA45CAT3G	SVC	45	2.5	50.00	52.65	55.30	1	72.2	5.5	-
SZ1SMA48CAT3G	SXC	48	2.5	53.30	56.11	58.91	1	77.4	5.2	X
SZ1SMA51CAT3G	SZC	51	2.5	56.70	59.70	62.70	1	82.4	4.9	-
SZ1SMA54CAT3G	TEC	54	2.5	60.00	63.15	66.30	1	87.1	4.6	-
SZ1SMA58CAT3G	TGC	58	2.5	64.40	67.79	71.18	1	93.6	4.3	X
SZ1SMA60CAT3G	TKC	60	2.5	66.70	70.21	73.72	1	96.8	4.1	X
SZ1SMA70CAT3G	TPC	70	2.5	77.80	81.90	85.99	1	113.0	3.5	X
SZ1SMA75CAT3G	TRC	75	2.5	83.30	87.70	92.10	1	121.0	3.3	-
SZ1SMA78CAT3G	TTC	78	2.5	86.70	91.27	95.83	1	126.0	3.2	X

6. A transient suppressor is normally selected according to the working peak reverse voltage ( $V_{RWM}$ ), which should be equal to or greater than the DC or continuous peak operating voltage level

7.  $V_{BR}$  measured at pulse test current  $I_T$  at an ambient temperature of 25°C

8. Surge current waveform per Figure 2 and derate per Figure 3

9. Bias voltage = 0 V, F = 1.0 MHz,  $T_j = 25^\circ\text{C}$ .

# SZ1SMA Series

## Surface Mount > 400W

### Ratings and Characteristic Curves

Figure 1. Pulse Rating Curve

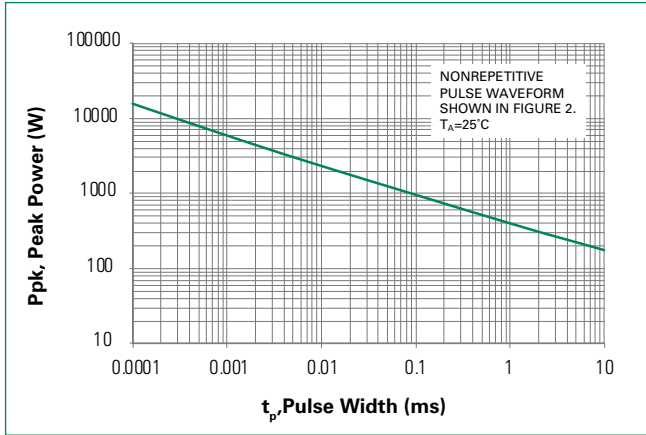

Figure 2. Pulse Waveform

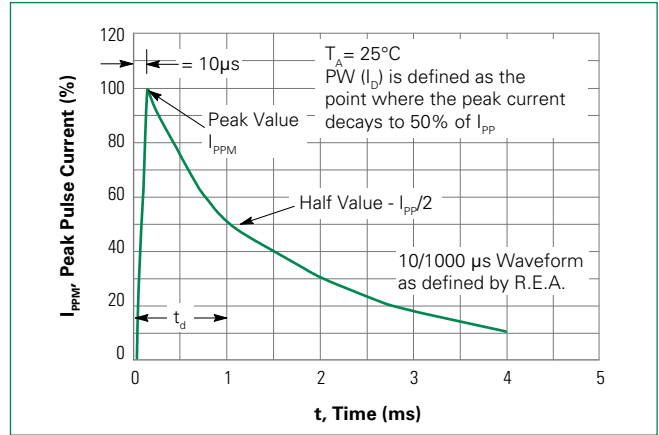

Figure 3 - Surge Derating Curve

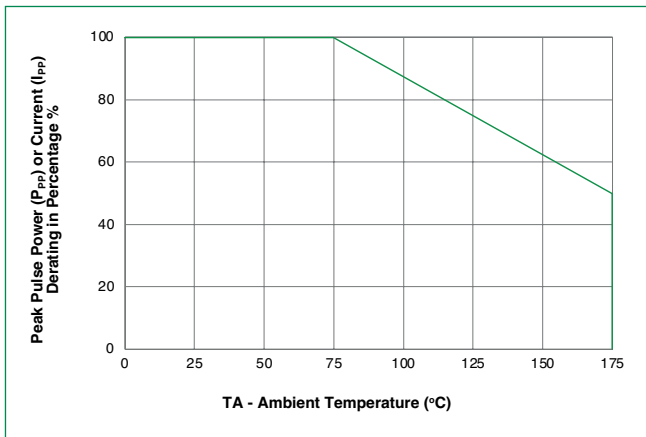

Figure 4. Typical Junction Capacitance vs. Bias Voltage

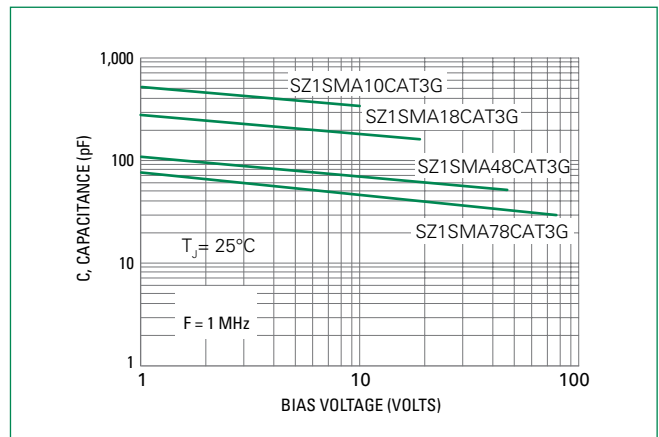

Figure 5. Typical Junction Capacitance vs. Bias Voltage

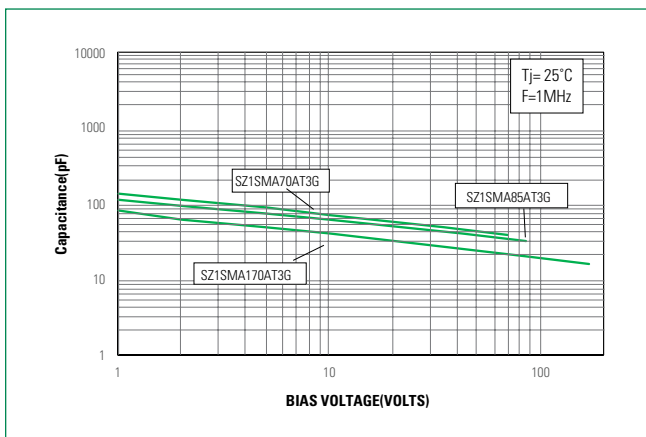
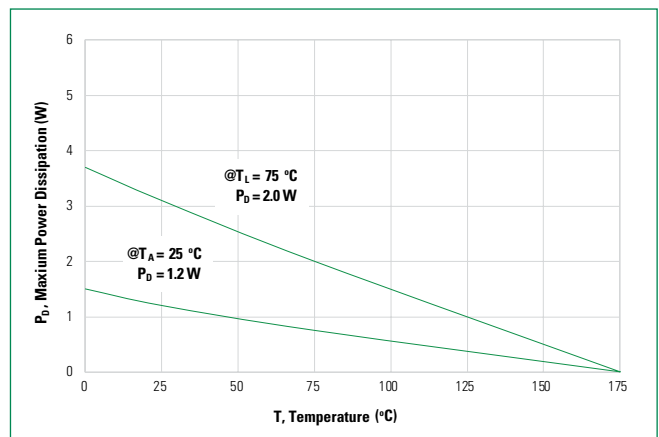

Figure 6. Steady State Power Derating



# SZ1SMA Series

## Surface Mount > 400W

### Soldering Parameters

<b>Reflow Condition</b>		Lead-free assembly
<b>Pre Heat</b>	- Temperature Min ( $T_{s(min)}$ )	150°C
	- Temperature Max ( $T_{s(max)}$ )	200°C
	- Time (min to max) ( $t_s$ )	60 – 120 secs
<b>Average ramp up rate (Liquidus Temp (<math>T_L</math>) to peak)</b>		3°C/second max
<b><math>T_{s(max)}</math> to <math>T_L</math> - Ramp-up Rate</b>		3°C/second max
<b>Reflow</b>	- Temperature ( $T_L$ ) (Liquidus)	217°C
	- Time (min to max) ( $t_L$ )	60 – 150 seconds
<b>Peak Temperature (<math>T_p</math>)</b>		260 <sup>+0/-5</sup> °C
<b>Time within 5°C of actual peak Temperature (<math>t_p</math>)</b>		30 seconds max
<b>Ramp-down Rate</b>		6°C/second max
<b>Time 25°C to peak Temperature (<math>T_p</math>)</b>		8 minutes max.
<b>Do not exceed</b>		260°C

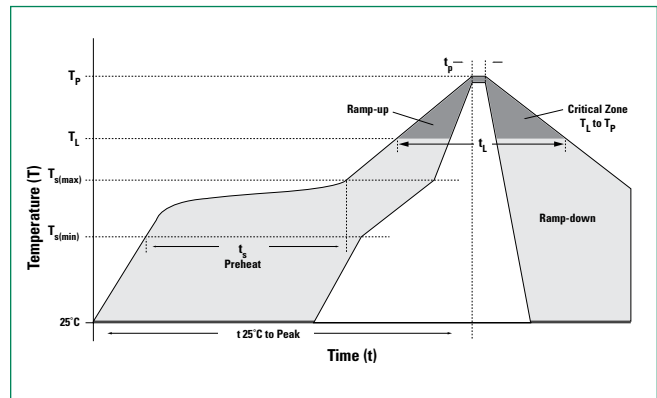

### Physical Specifications

<b>Weight</b>	0.00246 ounce, 0.0767 grams
<b>Case</b>	JEDEC DO214AC. Void-Free, Transfer-Molded, Thermosetting Plastic Epoxy Meets UL 94V-0
<b>Polarity</b>	Color band denotes cathode for unidirectional components.
<b>Terminal</b>	Matte Tin-plated leads, Solderable per JESD22-B102

### Environmental Specifications

<b>High Temp. Storage</b>	JESD22-A103
<b>HTRB</b>	JESD22-A108
<b>Temperature Cycling</b>	JESD22-A104
<b>MSL</b>	JEDEC-J-STD-020, Level 1
<b>H3TRB</b>	JESD22-A101
<b>RSH</b>	JESD22-A111

### Soldering Footprint

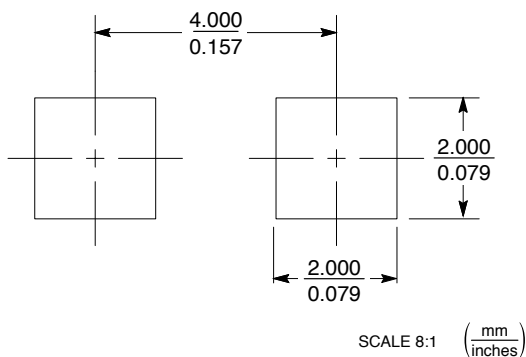

### Dimensions

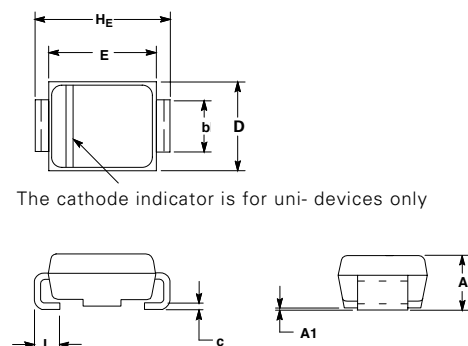

### Ordering Information

Device**	Package	Shipping
SZ1SMAxxAT3G	SMA (Pb-Free)	5,000 /Tape & Reel
SZ1SMAxxCAT3G	SMA (Pb-Free)	5,000 /Tape & Reel

\*\*The "T3" suffix refers to a 13 inch reel

Dim	Inches			Millimeters		
	Min	Nom	Max	Min	Nom	Max
<b>A</b>	0.078	0.083	0.087	1.97	2.10	2.20
<b>A1</b>	0.002	0.004	0.008	0.05	0.10	0.20
<b>b</b>	0.050	0.057	0.064	1.27	1.45	1.63
<b>c</b>	0.006	0.011	0.016	0.15	0.28	0.41
<b>D</b>	0.090	0.103	0.115	2.29	2.60	2.92
<b>E</b>	0.160	0.170	0.180	4.06	4.32	4.57
<b>H<sub>E</sub></b>	0.190	0.205	0.220	4.83	5.21	5.59
<b>L</b>	0.030	0.045	0.060	0.76	1.14	1.52

# SZ1SMA Series

## Surface Mount > 400W

### Part Marking System

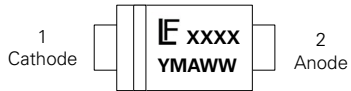

XXXX = Device Code (max four digits)  
 Y = Year  
 M = Month  
 A = Assembly Location  
 WW = Lot Code

### Part Numbering System

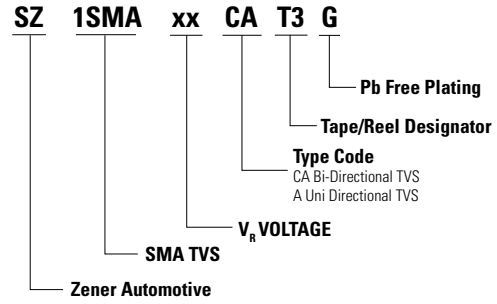

### Tape and Reel Specification

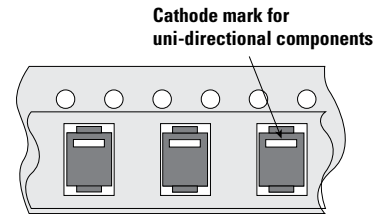
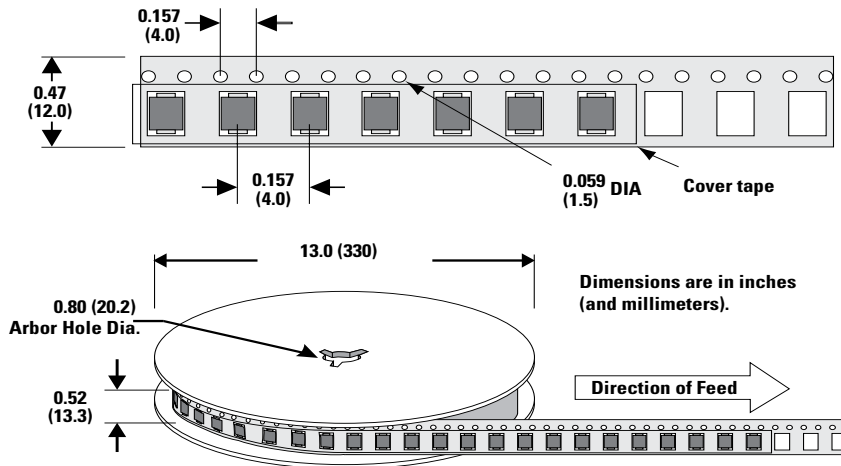

**Disclaimer Notice** - Information furnished is believed to be accurate and reliable. However, users should independently evaluate the suitability of and test each product selected for their own applications. Littelfuse products are not designed for, and may not be used in, all applications. Read complete Disclaimer Notice at: [www.littelfuse.com/disclaimer-electronics](http://www.littelfuse.com/disclaimer-electronics).