

SZ1.5SMC Series

Surface Mount > 1500W



Web Resources



Download ECAD models, order samples, and find technical resources at www.littelfuse.com

Agency Approvals

Agency	Agency File Number
	E128662

Maximum Ratings and Thermal Characteristics

Parameter	Symbol	Value	Unit
Peak Power Dissipation (Note 1) @ $T_L = 25^\circ\text{C}$, Pulse Width = 1 ms	P_{PK}	1500	W
DC Power Dissipation @ $T_L = 75^\circ\text{C}$ Measured Zero Lead Length (Note 2)	P_D	5.4	W
Derate Above 75°C		54.6	mW/ $^\circ\text{C}$
Thermal Resistance from Junction-to-Lead	$R_{\theta JL}$	18.3	$^\circ\text{C}/\text{W}$
DC Power Dissipation (Note 3) @ $T_A = 25^\circ\text{C}$	P_D	2.0	W
Derate Above 25°C		13.3	mW/ $^\circ\text{C}$
Thermal Resistance from Junction-to-Ambient	$R_{\theta JA}$	75	$^\circ\text{C}/\text{W}$
Forward Surge Current (Note 4) @ $T_A = 25^\circ\text{C}$	I_{FSM}	200	A
Operating and Storage Temperature Range	T_J, T_{stg}	-65 to +175	$^\circ\text{C}$

Stresses exceeding Maximum Ratings may damage the device. Maximum Ratings are stress ratings only. Functional operation above the Recommended Operating Conditions is not implied. Extended exposure to stresses above the Recommended Operating Conditions may affect device reliability.

- 10 x 1000 μs , non-repetitive.
- 1 in square copper pad, FR-4 board.
- FR-4 board, using Littelfuse minimum recommended footprint, as shown in 403-03 case outline dimensions spec.
- 1/2 sine wave (or equivalent square wave), $P_w = 8.3$ ms, duty cycle = 4 pulses per minute maximum.

Description

The SZ1.5SMC series is designed to protect voltage sensitive components from high voltage, high energy transients. They have excellent clamping capability, high surge capability, low zener impedance and fast response time. The SZ1.5SMC series is supplied in cost-effective, highly reliable DO-214AB package and it is ideal for use in automotive electronic applications.

Features & Benefits

- Zener Transient Overvoltage Suppressors
- Working Peak Reverse Voltage Range – 5.8 V to 171 V
- Standard Zener Breakdown Voltage Range – 6.45 V to 210 V
- Peak Power – 1500 W @ 1 ms
- ESD protection of data lines in accordance with IEC 61000-4-2 30kV(Air), 30kV (Contact)
- ESD Rating of Class 3 (> 16 KV) per Human Body Model
- Maximum Clamp Voltage @ Peak Pulse Current
- Low Leakage < 5 μA Above 10 V
- $V_{BR @ T_J} = V_{BR @ 25^\circ\text{C}} \times (1 + \alpha T \times (T_J - 25))$ (α : Temperature Coefficient)
- Recognized to UL 497B as an Isolated Loop Circuit Protector
- Maximum Temperature Coefficient Specified
- Response Time is Typically < 1 ns
- Pb-Free Packages are Available
- SZ Prefix for Automotive and Other Applications Requiring Unique Site and Control Change Requirements; AEC-Q101 Qualified and PPAP Capable

Functional Diagram

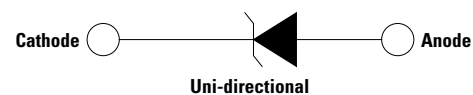

SZ1.5SMC Series

Surface Mount > 1500W

Electrical Characteristics ($T_A = 25^\circ\text{C}$ unless otherwise noted)

Device	Device Marking	V_{RWM} (Note 6)	$I_F @$ V_{RWM}	Breakdown Voltage				$V_C @ I_{PP}$ (Note 8)		MV BR TYP.	Agency Approval
				V_{BR} (V) (Note 7)			@ I_T	V_C	I_{PP}		
				Min	Nom	Max					
SZ1.5SMC6.8AT3G	6V8A	5.8	1000	6.45	6.8	7.14	10	10.5	143	0.057	x
SZ1.5SMC7.5AT3G	7V5A	6.4	500	7.13	7.5	7.88	10	11.3	132	0.061	x
SZ1.5SMC8.2AT3G	8V2A	7.02	200	7.79	8.20	8.61	10	12.1	124.0	0.065	x
SZ1.5SMC9.1AT3G	9V1A	7.78	50	8.65	9.10	9.55	1	13.4	112.0	0.068	x
SZ1.5SMC10AT3G	10A	8.55	10	9.5	10	10.5	1	14.5	103	0.073	x
SZ1.5SMC11AT3G	11A	9.40	10	10.50	11.05	11.60	1	15.6	96.0	0.075	x
SZ1.5SMC12AT3G	12A	10.2	5	11.4	12	12.6	1	16.7	90	0.078	x
SZ1.5SMC13AT3G	13A	11.1	5	12.4	13	13.7	1	18.2	82	0.081	x
SZ1.5SMC15AT3G	15A	12.8	5	14.3	15	15.8	1	21.2	71	0.084	x
SZ1.5SMC16AT3G	16A	13.6	5	15.2	16	16.8	1	22.5	67	0.086	x
SZ1.5SMC18AT3G	18A	15.3	5	17.1	18	18.9	1	25.2	59.5	0.088	x
SZ1.5SMC20AT3G	20A	17.1	5	19	20	21	1	27.7	54	0.09	x
SZ1.5SMC22AT3G	22A	18.8	5	20.9	22	23.1	1	30.6	49	0.092	x
SZ1.5SMC24AT3G	24A	20.5	5	22.8	24	25.2	1	33.2	45	0.094	x
SZ1.5SMC27AT3G	27A	23.1	5	25.7	27	28.4	1	37.5	40	0.096	x
SZ1.5SMC30AT3G	30A	25.6	5	28.5	30	31.5	1	41.4	36	0.097	x
SZ1.5SMC33AT3G	33A	28.2	5	31.4	33	34.7	1	45.7	33	0.098	x
SZ1.5SMC36AT3G	36A	30.8	5	34.2	36	37.8	1	49.9	30	0.099	x
SZ1.5SMC39AT3G	39A	33.3	5	37.1	39	41	1	53.9	28	0.1	x
SZ1.5SMC43AT3G	43A	36.8	5	40.9	43	45.2	1	59.3	25.3	0.101	x
SZ1.5SMC47AT3G	47A	40.2	5	44.7	47	49.4	1	64.8	23.2	0.101	x
SZ1.5SMC51AT3G	51A	43.6	5	48.5	51	53.6	1	70.1	21.4	0.102	x
SZ1.5SMC56AT3G	56A	47.8	5	53.2	56	58.8	1	77	19.5	0.103	x
SZ1.5SMC62AT3G	62A	53	5	58.9	62	65.1	1	85	17.7	0.104	x
SZ1.5SMC68AT3G	68A	58.1	5	64.6	68	71.4	1	92	16.3	0.104	x
SZ1.5SMC75AT3G	75A	64.1	5	71.3	75	78.8	1	103	14.6	0.105	x
SZ1.5SMC82AT3G	82A	70.1	5	77.9	82	86.1	1	113	13.3	0.105	x
SZ1.5SMC91AT3G	91A	77.8	5	86.5	91	95.5	1	125	12	0.106	x
SZ1.5SMC100AT3G	100A	85.50	5	95.00	100.00	105.00	1	137.0	11.0	0.106	-
SZ1.5SMC110AT3G	110A	94.00	5	105.00	110.50	116.00	1	152.0	9.9	0.107	-
SZ1.5SMC120AT3G	120A	102.00	5	114.00	120.00	126.00	1	165.0	9.1	0.107	-
SZ1.5SMC130AT3G	130A	111.00	5	124.00	130.50	137.00	1	179.0	8.4	0.107	-
SZ1.5SMC150AT3G	150A	128.00	5	143.00	150.50	158.00	1	207.0	7.3	0.108	-
SZ1.5SMC160AT3G	160A	136.00	5	152.00	160.00	168.00	1	219.0	6.9	0.108	-
SZ1.5SMC170AT3G	180A	145.00	5	162.00	170.50	179.00	1	234.0	6.4	0.108	-
SZ1.5SMC180AT3G	180A	154.00	5	171.00	180.00	189.00	1	246.0	6.1	0.108	-
SZ1.5SMC200AT3G	200A	171.00	5	190.00	200.00	210.00	1	274.0	5.5	0.108	-

Notes:

- A transient suppressor is normally selected according to the maximum working peak reverse voltage (V_{RWM}), which should be equal to or greater than the DC or continuous peak operating voltage level.
- V_{BR} measured at pulse test current I_T at an ambient temperature of 25°C .
- Surge current waveform per Figure 2 and derate per Figure 3 of the General Data - 1500 Watt at the beginning of this group.

SZ1.5SMC Series

Surface Mount > 1500W

I-V Curve Characteristics ($T_A = 25^\circ\text{C}$ unless otherwise noted, $V_F = 3.5\text{ V Max @ } I_F = 100\text{ A}$) (Note 5)

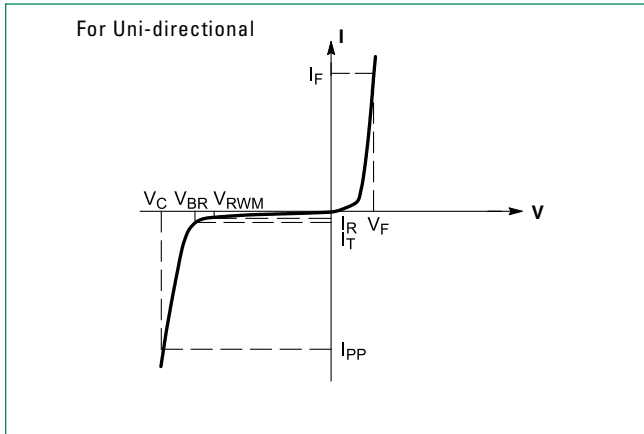

Symbol	Parameter
I_{PP}	Maximum Reverse Peak Pulse Current
V_C	Clamping Voltage @ I_{PP}
V_{RWM}	Working Peak Reverse Voltage
I_R	Maximum Reverse Leakage Current @ V_{RWM}
V_{BR}	Breakdown Voltage @ I_T
I_T	Test Current
I_F	Forward Current
V_F	Forward Voltage @ I_F

Note 5: 1/2 sine wave (or equivalent square wave), PW = 8.3 ms, non-repetitive duty cycle.

Ratings and Characteristic Curves

Figure 1. Pulse Rating Curve

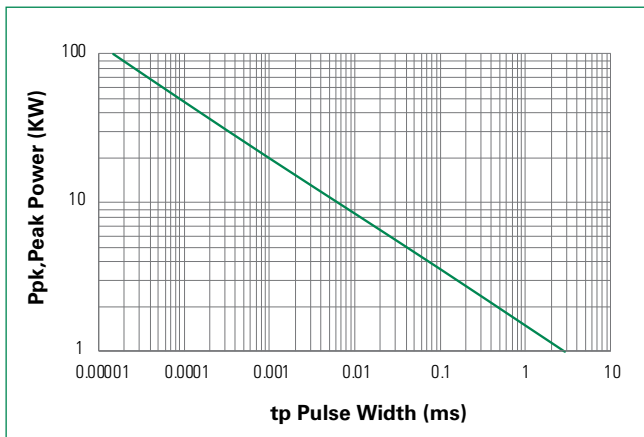

Figure 2. Pulse Waveform

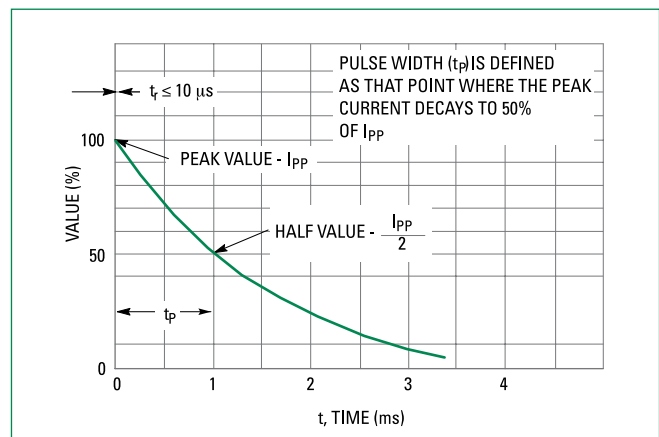

Figure 3. Surge Derating Curve

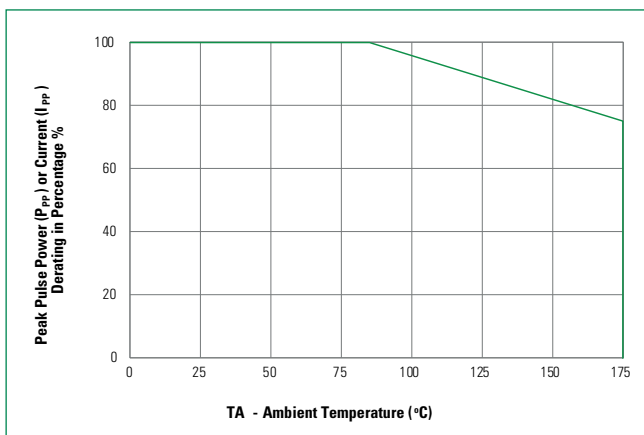
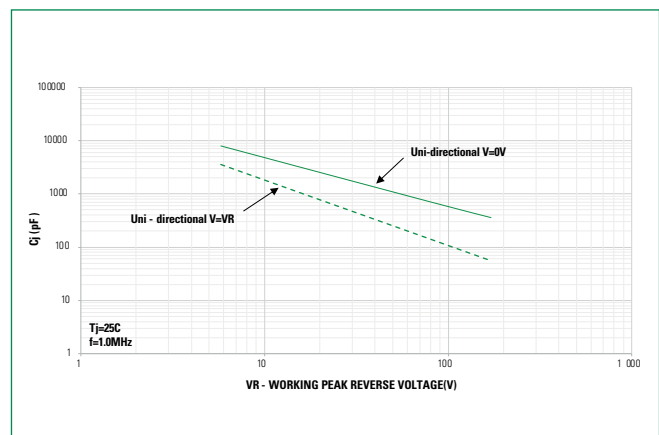

Figure 4. Typical Junction Capacitance



SZ1.5SMC Series

Surface Mount > 1500W

Soldering Parameters

Reflow Condition		Lead-free assembly
Pre Heat	- Temperature Min ($T_{s(\min)}$)	150°C
	- Temperature Max ($T_{s(\max)}$)	200°C
	- Time (min to max) (t_s)	60 – 120 secs
Average ramp up rate (Liquidus Temp (T_L) to peak)		3°C/second max
$T_{s(\max)}$ to T_L - Ramp-up Rate		3°C/second max
Reflow	- Temperature (T_L) (Liquidus)	217°C
	- Time (min to max) (t_L)	60 – 150 seconds
Peak Temperature (T_p)		260 ^{+0/-5} °C
Time within 5°C of actual peak Temperature (t_p)		30 seconds max
Ramp-down Rate		6°C/second max
Time 25°C to peak Temperature (T_p)		8 minutes max.
Do not exceed		260°C

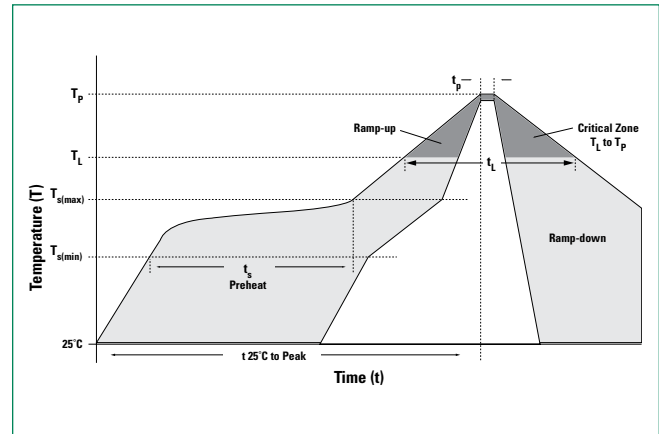

Physical Specifications

Weight	0.00733 ounce, 0.228 grams
Case	JEDEC DO214AB. Void-Free, Transfer-Molded, Thermosetting Plastic Epoxy Meets UL 94V-0
Polarity	Color band denotes cathode for unidirectional components.
Terminal	Matte Tin-plated leads, Solderable per JESD22-B102

Environmental Specifications

High Temp. Storage	JESD22-A103
HTRB	JESD22-A108
Temperature Cycling	JESD22-A104
MSL	JEDEC-J-STD-020, Level 1
H3TRB	JESD22-A101
RSH	JESD22-A111

Dimensions

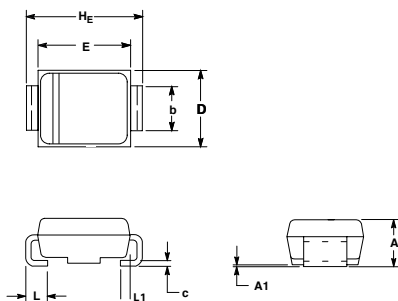

Soldering Footprint

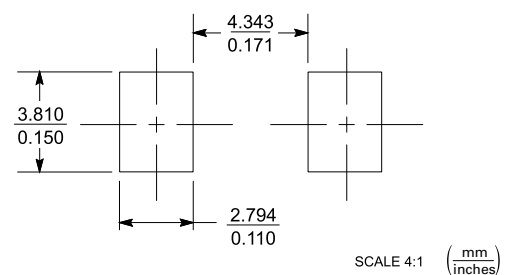

Ordering Information

Device	Package	Shipping
SZ1.5SMCxxAT3G	SMC (Pb-Free)	2,500 / Tape & Reel

Dim	Inches			Millimeters		
	Min	Nom	Max	Min	Nom	Max
A	0.079	0.087	0.095	2.00	2.22	2.41
A1	0.002	0.004	0.008	0.05	0.10	0.20
b	0.115	0.118	0.125	2.92	3.00	3.18
c	0.006	0.009	0.012	0.15	0.23	0.30
D	0.220	0.230	0.240	5.59	5.84	6.10
E	0.260	0.270	0.280	6.60	6.86	7.11
HE	0.305	0.313	0.320	7.75	7.94	8.13
L	0.030	0.040	0.050	0.76	1.02	1.27
L1	0.020 REF			0.51 REF		

SZ1.5SMC Series

Surface Mount > 1500W

Part Marking System

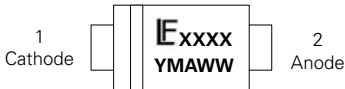

XXXX = Device Code (max four digits)
Y = Year
M = Month
A = Assembly Location
WW = Lot Code

Part Numbering System

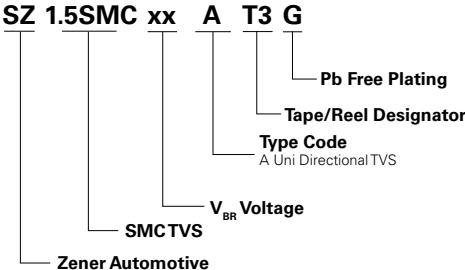

Tape and Reel Specification

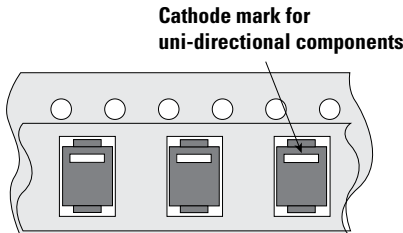
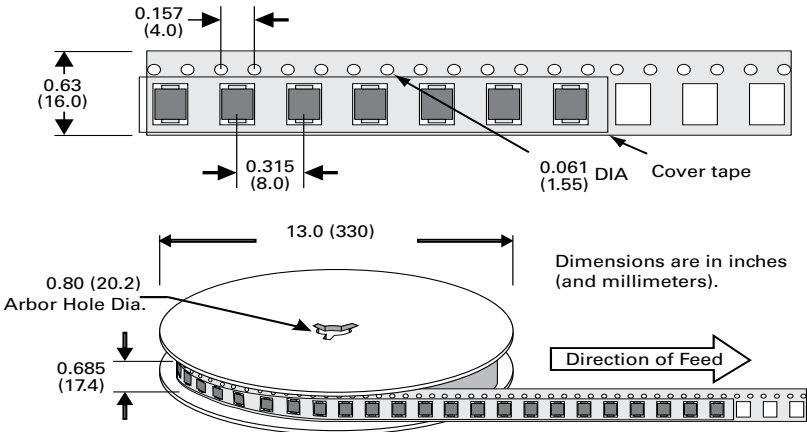

Disclaimer Notice - Information furnished is believed to be accurate and reliable. However, users should independently evaluate the suitability of and test each product selected for their own applications. Littelfuse products are not designed for, and may not be used in, all applications. Read complete Disclaimer Notice at: www.littelfuse.com/disclaimer-electronics.