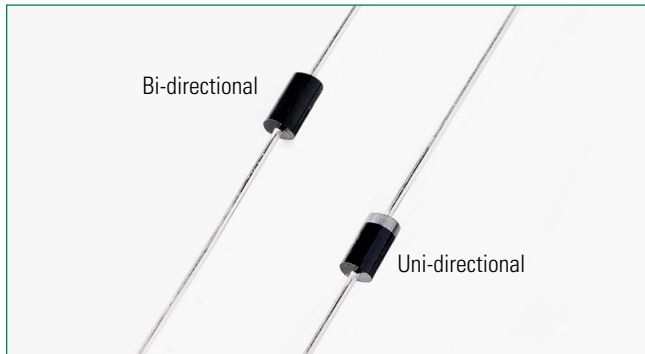


**SA Series**



**Agency Approvals**

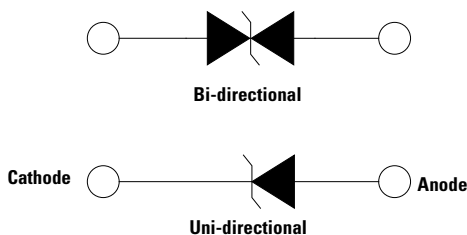
Agency	Agency File Number
	E230531

**Maximum Ratings and Thermal Characteristics (T<sub>A</sub> = 25°C unless otherwise noted)**

Parameter	Symbol	Value	Unit
Peak Pulse Power Dissipation by 10/1000µs Test Waveform (Fig.2)(Note 1)	P <sub>PPM</sub>	500	W
Steady State Power Dissipation on Infinite Heat Sink at T <sub>L</sub> = 75°C	P <sub>D</sub>	3.0	W
Peak Forward Surge Current, 8.3ms Single Half Sine Wave Unidirectional Only (Note 2)	I <sub>FSM</sub>	70	A
Maximum Instantaneous Forward Voltage at 35A for Unidirectional Only	V <sub>F</sub>	3.5	V
Operating Junction and Storage Temperature Range	T <sub>J</sub> , T <sub>STG</sub>	-65 to 175	°C
Typical Thermal Resistance Junction to Lead	R <sub>θJL</sub>	20	°C/W
Typical Thermal Resistance Junction to Ambient	R <sub>θJA</sub>	75	°C/W

**Notes:**  
 1. Non-repetitive current pulse, per Fig. 4 and derated above T<sub>J</sub> (initial) = 25°C per Fig. 3.  
 2. Measured on 8.3ms single half sine wave or equivalent square wave, duty cycle=4 per minute maximum.

**Functional Diagram**



**Description**

The SA Series is designed specifically to protect sensitive electronic equipment from voltage transients induced by lightning and other transient voltage events.

**Features**

- 500W peak pulse capability at 10/1000µs waveform, repetition rate (duty cycles):0.01 %
- V<sub>BR</sub> @ T<sub>J</sub> = V<sub>BR</sub> @ 25°C x (1 + α T (T<sub>J</sub> - 25)) (α T: Temperature Coefficient, typical value is 0.1 %)
- Glass passivated chip junction in DO-15 Package
- Fast response time: typically less than 1.0ps from 0 Volts to BV min
- Excellent clamping capability
- Typical failure mode is short from over-specified voltage or current
- Whisker test is conducted based on JEDEC JESD201A per its table 4a and 4c
- IEC-61000-4-2 ESD 30kV(Air), 30kV (Contact)
- ESD protection of data lines in accordance with IEC 61000-4-2
- EFT protection of data lines in accordance with IEC 61000-4-4
- Low incremental surge resistance
- Typical I<sub>R</sub> less than 1µA when V<sub>BR</sub> max > 13V
- High temperature to reflow soldering guaranteed: 260°C/40sec / 0.375"/(9.5mm) lead length, 5 lbs., (2.3kg) tension
- Plastic package is flammability rated V-0 per Underwriters Laboratories
- Matte tin lead-free plated
- Halogen free and RoHS compliant
- Pb-free E3 means 2nd level interconnect is Pb-free and the terminal finish material is tin(Sn) (IPC/ JEDEC J-STD-609A.01)


**Applications**

TVS devices are ideal for the protection of I/O interfaces, V<sub>CC</sub> bus and other vulnerable circuits used in telecom, computer, industrial and consumer electronic applications.

**Additional Information**



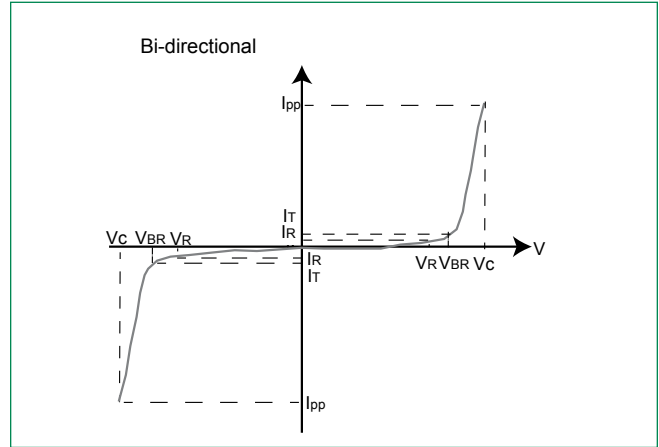
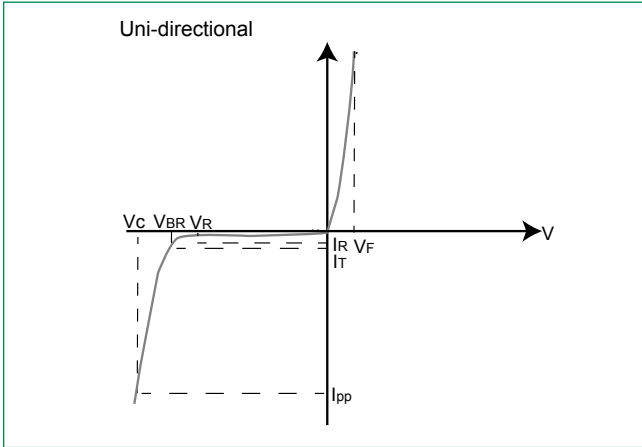
### Electrical Characteristics (T<sub>A</sub>=25°C unless otherwise noted)

Part Number (Uni)	Part Number (Bi)	Reverse Stand off Voltage V <sub>R</sub> (V)	Breakdown Voltage V <sub>BR</sub> (Volts) @ I <sub>T</sub>		Test Current I <sub>T</sub> (mA)	Maximum Clamping Voltage V <sub>C</sub> @ I <sub>PP</sub> (V)	Maximum Peak Pulse Current I <sub>PP</sub> (A)	Maximum Reverse Leakage I <sub>R</sub> @ V <sub>R</sub> (μA)	Agency Approval 
			Min.	Max.					
SA5.0A	SA5.0CA	5.0	6.40	7.00	10	9.2	55.4	600	X
SA6.0A	SA6.0CA	6.0	6.67	7.37	10	10.3	49.5	600	X
SA6.5A	SA6.5CA	6.5	7.22	7.98	10	11.2	45.5	400	X
SA7.0A	SA7.0CA	7.0	7.78	8.60	10	12.0	42.5	150	X
SA7.5A	SA7.5CA	7.5	8.33	9.21	1	12.9	39.5	50	X
SA8.0A	SA8.0CA	8.0	8.89	9.83	1	13.6	37.5	25	X
SA8.5A	SA8.5CA	8.5	9.44	10.40	1	14.4	35.4	10	X
SA9.0A	SA9.0CA	9.0	10.00	11.10	1	15.4	33.1	5	X
SA10A	SA10CA	10.0	11.10	12.30	1	17.0	30.0	3	X
SA11A	SA11CA	11.0	12.20	13.50	1	18.2	28.0	1	X
SA12A	SA12CA	12.0	13.30	14.70	1	19.9	25.6	1	X
SA13A	SA13CA	13.0	14.40	15.90	1	21.5	23.7	1	X
SA14A	SA14CA	14.0	15.60	17.20	1	23.2	22.0	1	X
SA15A	SA15CA	15.0	16.70	18.50	1	24.4	20.9	1	X
SA16A	SA16CA	16.0	17.80	19.70	1	26.0	19.6	1	X
SA17A	SA17CA	17.0	18.90	20.90	1	27.6	18.5	1	X
SA18A	SA18CA	18.0	20.00	22.10	1	29.2	17.5	1	X
SA20A	SA20CA	20.0	22.20	24.50	1	32.4	15.7	1	X
SA22A	SA22CA	22.0	24.40	26.90	1	35.5	14.4	1	X
SA24A	SA24CA	24.0	26.70	29.50	1	38.9	13.1	1	X
SA26A	SA26CA	26.0	28.90	31.90	1	42.1	12.1	1	X
SA28A	SA28CA	28.0	31.10	34.40	1	45.4	11.2	1	X
SA30A	SA30CA	30.0	33.30	36.80	1	48.4	10.5	1	X
SA33A	SA33CA	33.0	36.70	40.60	1	53.3	9.6	1	X
SA36A	SA36CA	36.0	40.00	44.20	1	58.1	8.8	1	X
SA40A	SA40CA	40.0	44.40	49.10	1	64.5	7.9	1	X
SA43A	SA43CA	43.0	47.80	52.80	1	69.4	7.3	1	X
SA45A	SA45CA	45.0	50.00	55.30	1	72.7	7.0	1	X
SA48A	SA48CA	48.0	53.30	58.90	1	77.4	6.6	1	X
SA51A	SA51CA	51.0	56.70	62.70	1	82.4	6.2	1	X
SA54A	SA54CA	54.0	60.00	66.30	1	87.1	5.9	1	X
SA58A	SA58CA	58.0	64.40	71.20	1	93.6	5.4	1	X
SA60A	SA60CA	60.0	66.70	73.70	1	96.8	5.3	1	X
SA64A	SA64CA	64.0	71.10	78.60	1	103.0	5.0	1	X
SA70A	SA70CA	70.0	77.80	86.00	1	113.0	4.5	1	X
SA75A	SA75CA	75.0	83.30	92.10	1	121.0	4.2	1	X
SA78A	SA78CA	78.0	86.70	95.80	1	126.0	4.0	1	X
SA85A	SA85CA	85.0	94.40	104.00	1	137.0	3.7	1	X
SA90A	SA90CA	90.0	100.00	111.00	1	146.0	3.5	1	X
SA100A	SA100CA	100.0	111.00	123.00	1	162.0	3.1	1	X
SA110A	SA110CA	110.0	122.00	135.00	1	177.0	2.9	1	X
SA120A	SA120CA	120.0	133.00	147.00	1	193.0	2.6	1	X
SA130A	SA130CA	130.0	144.00	159.00	1	209.0	2.4	1	X
SA150A	SA150CA	150.0	167.00	185.00	1	243.0	2.1	1	X
SA160A	SA160CA	160.0	178.00	197.00	1	259.0	2.0	1	X
SA170A	SA170CA	170.0	189.00	209.00	1	275.0	1.9	1	X
SA180A	SA180CA	180.0	200.00	221.00	1	289.0	1.7	1	X

For bidirectional type having V<sub>R</sub> of 10 volts and less, the I<sub>T</sub> limit is double.

For parts without A, the V<sub>BR</sub> is ± 10% and V<sub>C</sub> is 5% higher than with A parts, the parts without A are currently available, but not recommended for new designs. The parts with A are preferred.

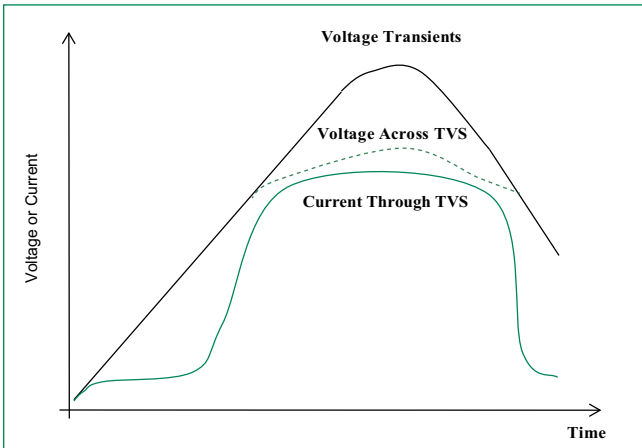
**I-V Curve Characteristics**



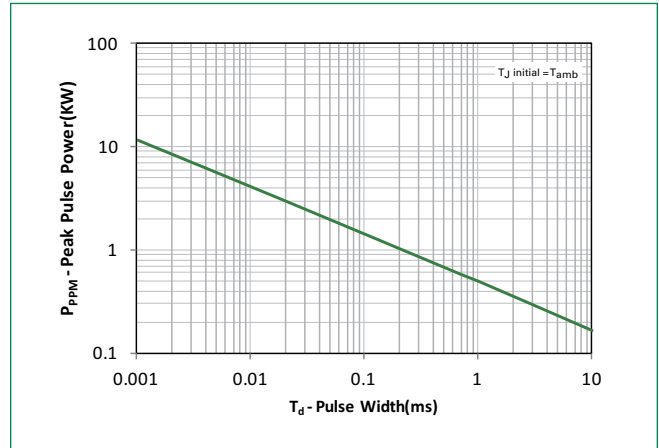
- $P_{PPM}$  **Peak Pulse Power Dissipation** – Max power dissipation
- $V_R$  **Stand-off Voltage** – Maximum voltage that can be applied to the TVS without operation
- $V_{BR}$  **Breakdown Voltage** – Maximum voltage that flows through the TVS at a specified test current ( $I_T$ )
- $V_C$  **Clamping Voltage** – Peak voltage measured across the TVS at a specified  $I_{ppm}$  (peak impulse current)
- $I_R$  **Reverse Leakage Current** – Current measured at  $V_R$
- $V_F$  **Forward Voltage Drop for Uni-directional**

**Ratings and Characteristic Curves** ( $T_A=25^\circ C$  unless otherwise noted)

**Figure 1 - TVS Transients Clamping Waveform**

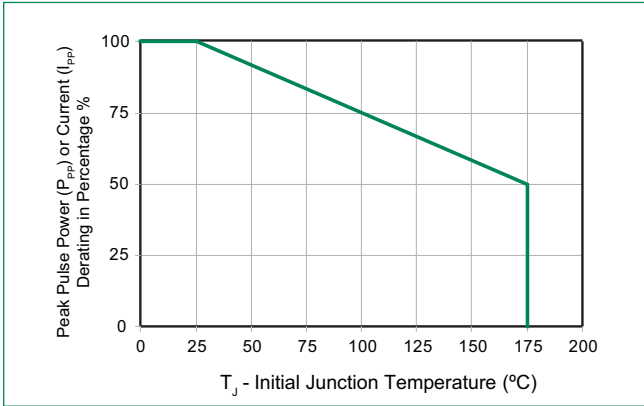


**Figure 2 - Peak Pulse Power Rating**

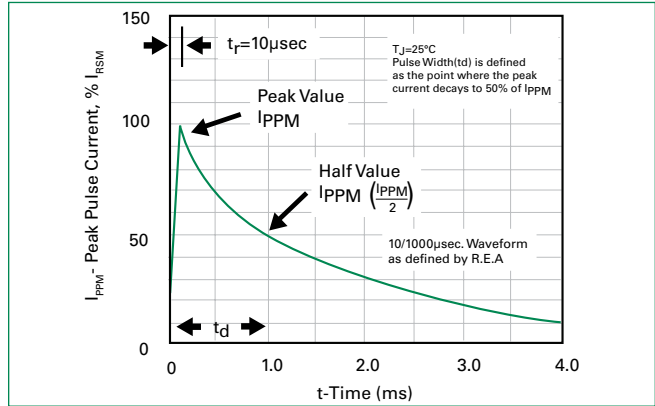


**Ratings and Characteristic Curves** ( $T_A=25^\circ\text{C}$  unless otherwise noted) (Continued)

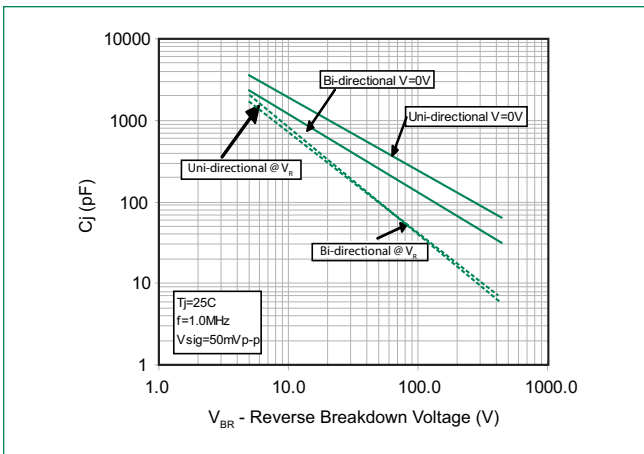
**Figure 3 - Peak Pulse Power Derating Curve**



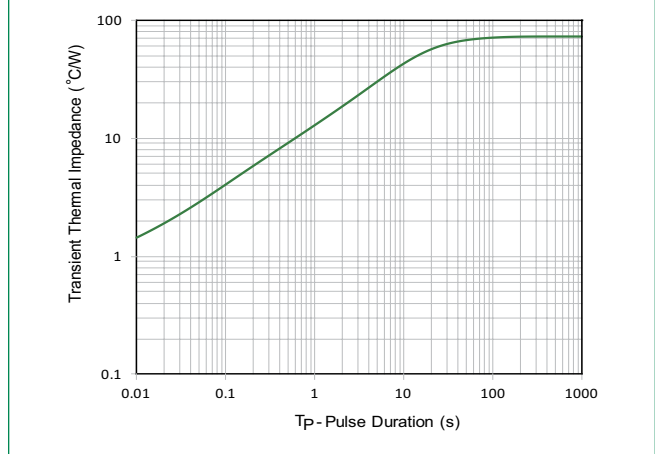
**Figure 4 - Pulse Waveform**



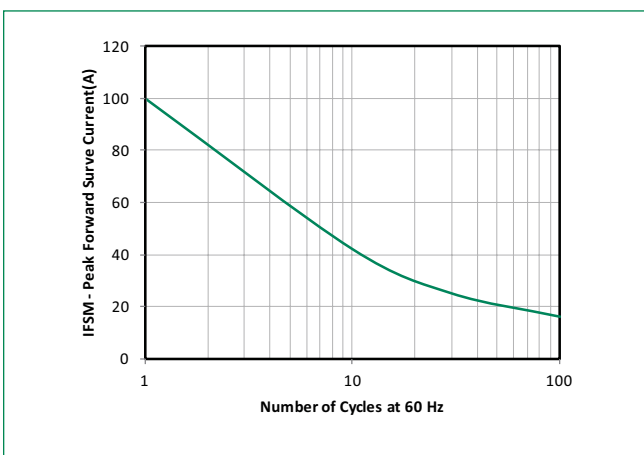
**Figure 5 - Typical Junction Capacitance**



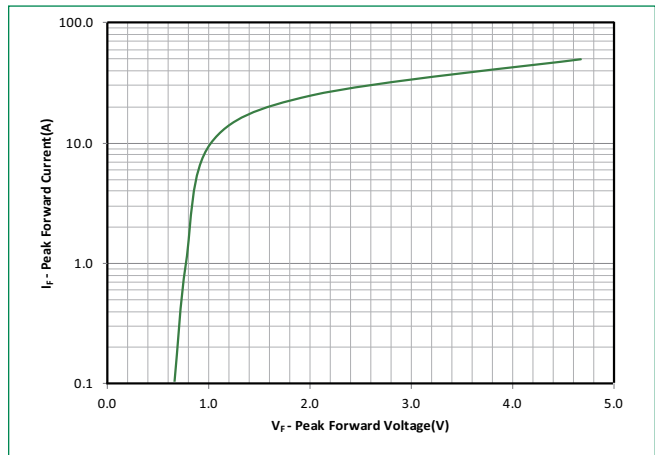
**Figure 6 - Typical Transient Thermal Impedance**



**Figure 7 - Maximum Non-Repetitive Forward Surge Current Uni-Directional Only**

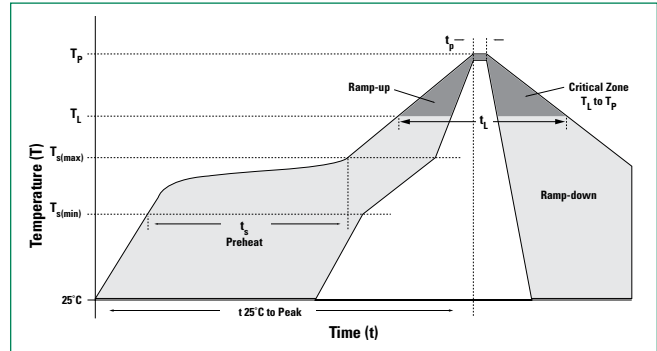


**Figure 8 - Peak Forward Voltage Drop vs Peak Forward Current (Typical Values)**



### Soldering Parameters

<b>Reflow Condition</b>		Lead-free assembly
<b>Pre Heat</b>	- Temperature Min ( $T_{s(min)}$ )	150°C
	- Temperature Max ( $T_{s(max)}$ )	200°C
	- Time (min to max) ( $t_s$ )	60 – 180 secs
<b>Average ramp up rate (Liquidus Temp (<math>T_A</math>) to peak</b>		3°C/second max
<b><math>T_{s(max)}</math> to <math>T_A</math> - Ramp-up Rate</b>		3°C/second max
<b>Reflow</b>	- Temperature ( $T_A$ ) (Liquidus)	217°C
	- Time (min to max) ( $t_s$ )	60 – 150 seconds
<b>Peak Temperature (<math>T_p</math>)</b>		260 <sup>+0/-5</sup> °C
<b>Time within 5°C of actual peak Temperature (<math>t_p</math>)</b>		20 – 40 seconds
<b>Ramp-down Rate</b>		6°C/second max
<b>Time 25°C to peak Temperature (<math>T_p</math>)</b>		8 minutes Max.
<b>Do not exceed</b>		260°C



### Flow/Wave Soldering (Solder Dipping)

<b>Peak Temperature :</b>	265°C
<b>Dipping Time :</b>	10 seconds
<b>Soldering :</b>	1 time

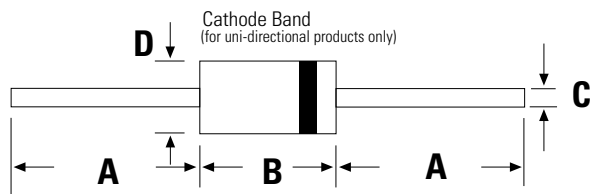
### Physical Specifications

<b>Weight</b>	0.015oz., 0.4g
<b>Case</b>	JEDEC DO-204AC (DO-15) molded plastic body over passivated junction.
<b>Polarity</b>	Color band denotes the cathode except Bipolar.
<b>Terminal</b>	Matte Tin axial leads, solderable per JESD22-B102.

### Environmental Specifications

<b>High Temp. Storage</b>	JESD22-A103
<b>HTRB</b>	JESD22-A108
<b>Temperature Cycling</b>	JESD22-A104
<b>H3TRB</b>	JESD22-A101
<b>RSH</b>	JESD22-B106

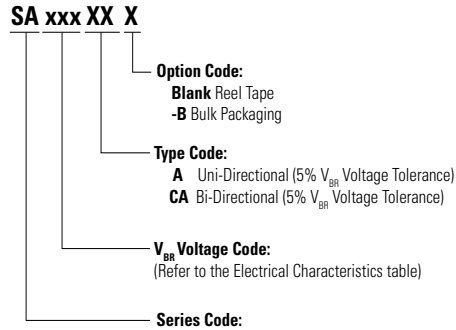
### Dimensions



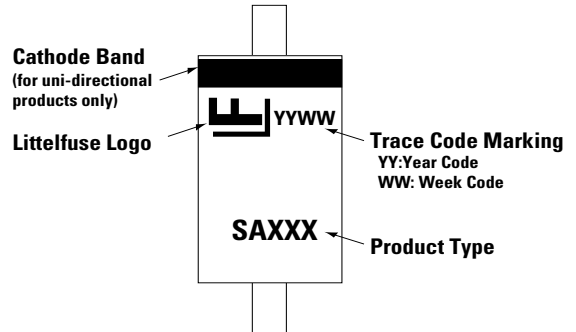
**DO-204AC (DO-15)**

Dimensions	Inches		Millimeters	
	Min	Max	Min	Max
<b>A</b>	1.000	-	25.40	-
<b>B</b>	0.230	0.300	5.80	7.60
<b>C</b>	0.028	0.034	0.71	0.86
<b>D</b>	0.104	0.140	2.60	3.60

### Part Numbering System



### Part Marking System



### Packaging

Part Number	Component Package	Quantity	Packaging Option	Packaging Specification
SAxxxXX	DO-204AC	4000	Tape & Reel	EIA STD RS-296
SAxxxXX-B	DO-204AC	1000	Bulk	Littelfuse Spec.

### Tape and Reel Specification

