

SR70 Series

70V 40A Diode Array



Additional Information



Resources



Accessories



Samples

Pinout

SOT-143-4

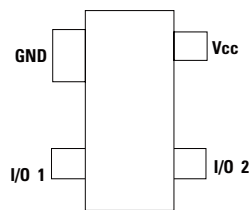

Description

The SR70 consists of four, low capacitance, rail-to-rail diodes that provide protection against ESD and lightning surge events. These robust diodes can safely absorb up to 40A ($t_p=8/20\mu s$) and repetitive ESD strikes at the maximum level (Level 4) specified in the IEC 61000-4-2 international standard without performance degradation.

Its low loading capacitance makes it ideal for protecting high-speed data lines such as VDSL and VDSL2.

Features & Benefits

- ESD, IEC61000-4-2, $\pm 30kV$ contact discharge, $\pm 30kV$ air discharge
- EFT, IEC61000-4-4, 80A ($t_p=5/50ns$)
- Lightning protection, IEC61000-4-5, 40A ($t_p=8/20\mu s$)
- Low capacitance of 2.0pF (TYP) per I/O
- Low clamp voltage
- Small SOT143 (JEDEC TO-253) packaging

Applications

- xDSL Lines
- Video Lines
- Customer Premises Equipment
- 10/100/1000 Ethernet

Application Example

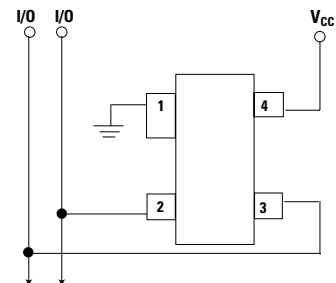

Functional Block Diagram

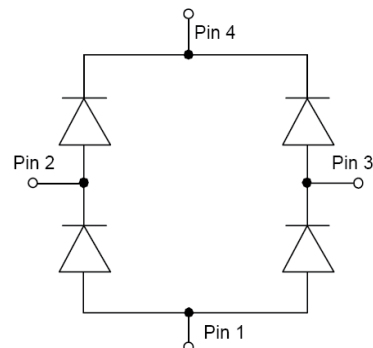

Life Support Note:

Not Intended for Use in Life Support or Life Saving Applications

The products shown herein are not designed for use in life sustaining or life saving applications unless otherwise expressly indicated.

SR70 Series

70V 40A Diode Array

Absolute Maximum Ratings

Symbol	Parameter	Value	Units
I_{PP}	Peak Current ($t_p=8/20\mu s$)	40.0	A
T_{OP}	Operating Temperature	-40 to 125	°C
T_{STOR}	Storage Temperature	-55 to 150	°C

Caution: Stresses above those listed in "Absolute Maximum Ratings" may cause permanent damage to the device. This is a stress only rating and operation of the device at these or any other conditions above those indicated in the operational sections of this specification is not implied.

Thermal Information

Parameter	Rating	Units
Storage Temperature Range	-55 to 150	°C
Maximum Junction Temperature	150	°C
Maximum Lead Temperature (Soldering 20-40s)	260	°C

Electrical Characteristics ($T_{OP}=25^\circ C$)

Parameter	Symbol	Test Conditions	Min	Typ	Max	Units
Reverse Standoff Voltage	V_{RWM}				70	V
Reverse Leakage Current	I_{LEAK}	$V_R=70V$			5	μA
Clamp Voltage ¹	V_C	$I_{PP}=1A, t_p=8/20\mu s, Fwd$		1.4		V
		$I_{PP}=10A, t_p=8/20\mu s, Fwd$		4.7		V
		$I_{PP}=30A, t_p=8/20\mu s, Fwd$		12		V
Dynamic Resistance	R_{DYN}	$(V_{C2}-V_{C1})/(I_{PP2}-I_{PP1})$		0.35		Ω
ESD Withstand Voltage ¹	V_{ESD}	IEC61000-4-2 (Contact)	± 30			kV
		IEC61000-4-2 (Air)	± 30			kV
Diode Capacitance ¹	$C_{I/O-GND}$	Reverse Bias=0V, f=1MHz		2.0	3.0	pF
	$C_{I/O-I/O}$	Reverse Bias=0V, f=1MHz		1.3	2.0	pF

Note: 1. Parameter is guaranteed by design and/or device characterization.

Capacitance vs. Reverse Bias

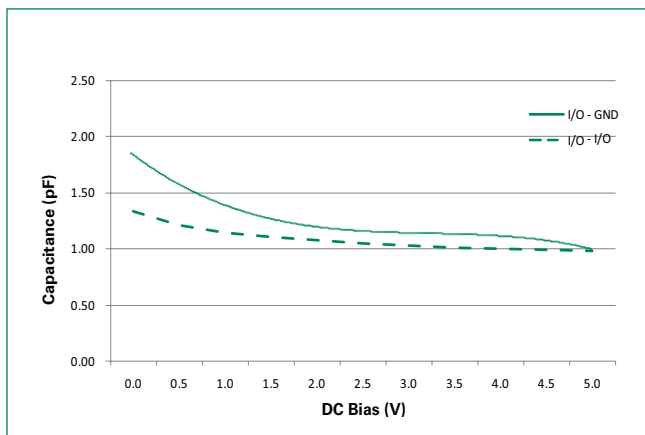

Pulse Waveform

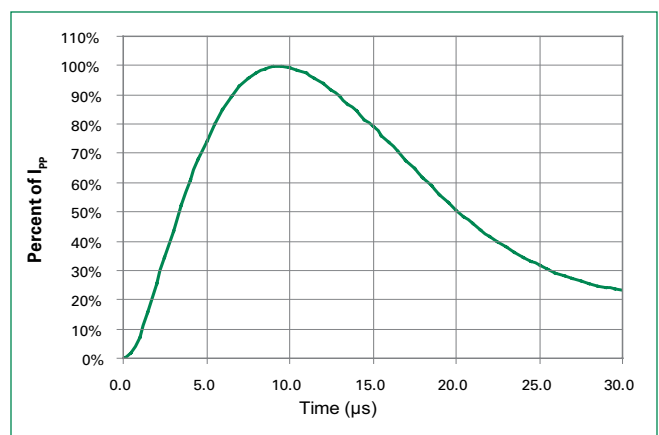

SR70 Series

70V 40A Diode Array

Clamping Voltage vs. I_{pp}

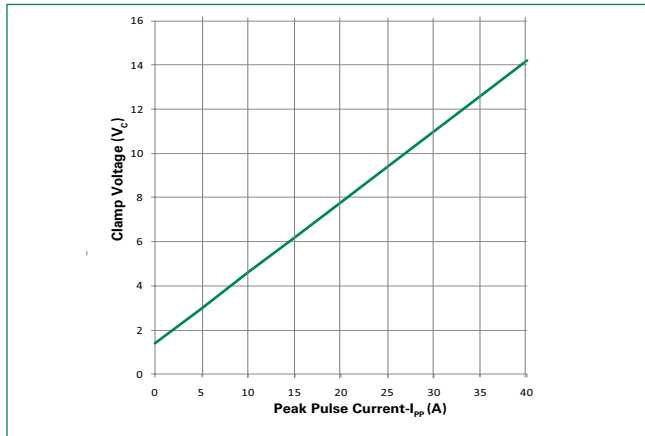

Product Characteristics

Lead Plating	Matte Tin
Lead Material	Copper Alloy
Lead Coplanarity	0.0004 inches (0.102mm)
Substitute Material	Silicon
Body Material	Molded Epoxy
Flammability	UL 94 V-0

Notes :

1. All dimensions are in millimeters
2. Dimensions include solder plating.
3. Dimensions are exclusive of mold flash & metal burr.
4. Blo is facing up for mold and facing down for trim/form, i.e. reverse trim/form.
5. Package surface matte finish VDI 11-13.

Soldering Parameters

Reflow Condition	Pb – Free assembly	
Pre Heat	- Temperature Min ($T_{s(min)}$)	150°C
	- Temperature Max ($T_{s(max)}$)	200°C
	- Time (min to max) (t_s)	60 – 180 secs
Average ramp up rate (Liquidus) Temp (T_L) to peak	3°C/second max	
$T_{s(max)}$ to T_L - Ramp-up Rate	3°C/second max	
Reflow	- Temperature (T_L) (Liquidus)	217°C
	- Temperature (t_L)	60 – 150 seconds
Peak Temperature (T_p)	260 ^{+0/-5} °C	
Time within 5°C of actual peak Temperature (t_p)	20 – 40 seconds	
Ramp-down Rate	6°C/second max	
Time 25°C to peak Temperature (T_p)	8 minutes Max.	
Do not exceed	260°C	

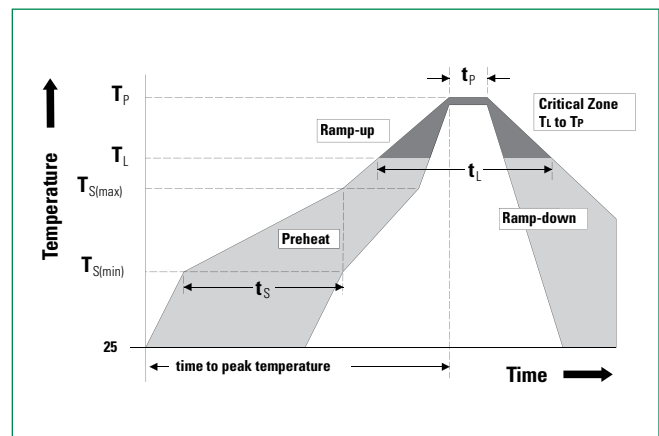

Part Numbering System

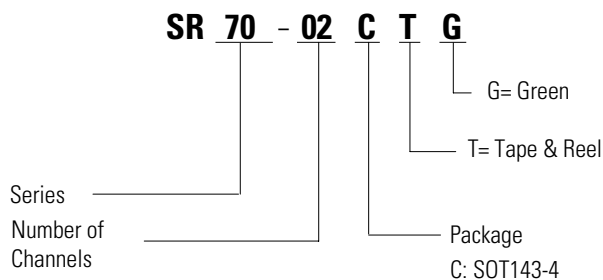

Ordering Information

Part Number	Package	Marking	Min. Order Qty.
SR70-02CTG	SOT143	702C	3000

Part Marking System

702C

SR70 Series

70V 40A Diode Array

Package Dimensions—SOT143

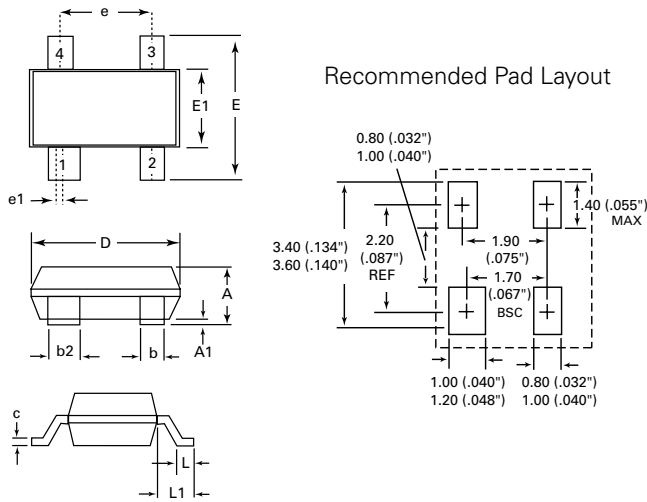

Package	SOT143			
Pins	4			
JEDEC	TO-253			
	Millimeters		Inches	
	Min	Max	Min	Max
A	0.8	1.22	0.03	0.048
A1	0.05	0.15	0.002	0.006
b	0.30	0.50	0.012	0.020
b2	0.76	0.89	0.030	0.035
c	0.08	0.20	0.003	0.008
D	2.80	3.04	0.110	0.120
E	2.10	2.64	0.082	0.104
E1	1.20	1.40	0.047	0.055
e	1.92 BSC		0.076 BSC	
e1	0.20 BSC		0.008 BSC	
L	0.4	0.6	0.016	0.024
L1	0.550 REF		0.022 REF	

Embossed Carrier Tape & Reel Specification—SOT143

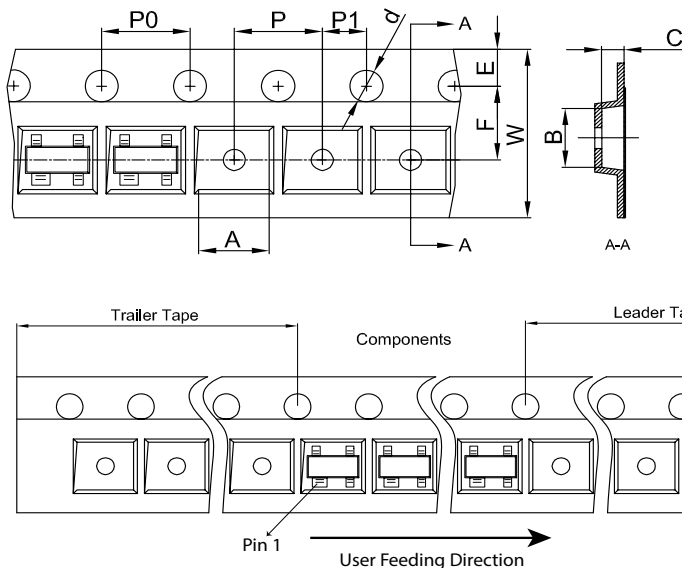

Symbol	Millimeters
A	3.19±0.10
B	2.8±0.10
C	1.31±0.10
d	∅ 1.50±0.10
E	1.75±0.10
F	3.50±0.10
P0	4.00±0.10
P	4.00±0.10
P1	2.00±0.10
W	8.00±0.10

Notes:
1. All dimensions are in millimeters

Disclaimer Notice - Information furnished is believed to be accurate and reliable. However, users should independently evaluate the suitability of and test each product selected for their own applications. Littelfuse products are not designed for, and may not be used in, all applications. Read complete Disclaimer Notice at www.littelfuse.com/disclaimer-electronics.