

SP4045 Series

Lightning Surge Protection

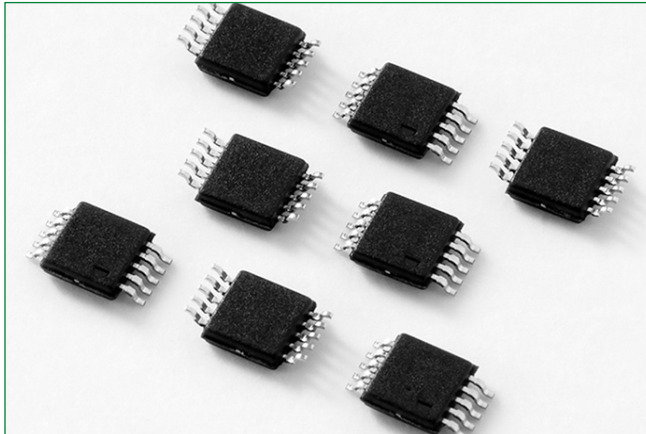

Additional Information



Resources



Accessories



Samples

Pinout

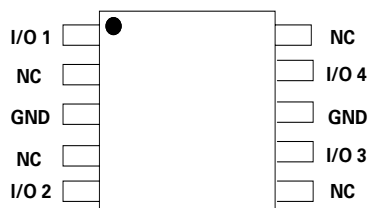

Description

The SP4045 integrates low capacitance diodes with an additional zener diode to protect each I/O pin against ESD and high surge events. This robust device can safely absorb up to 24A per IEC 61000-4-5 2nd edition ($t_p=8/20\mu s$) without performance degradation and a minimum $\pm 30kV$ ESD per IEC 61000-4-2 International Standard. Their low loading capacitance also makes them ideal for protecting high speed signal pins.

Features

- Signal-integrity-preserving straight through routing
- Low leakage current of $1\mu A$ (MAX) at 3.3V
- ESD, IEC 61000-4-2, $\pm 30kV$ contact, $\pm 30kV$ air
- EFT, IEC 61000-4-4, 40A (5/50ns)
- Lightning, IEC 61000-4-5 2nd edition, 24A (8/20 μs)
- Low capacitance of 1.5pF (TYP) per I/O
- AEC-Q101 qualified
- Halogen free, Lead free and RoHS compliant
- Moisture Sensitivity Level (MSL Level-1)

Applications

- HDBaseT Protector
- 10/100/1000 Ethernet
- 2.5 and 5 Gigabit Ethernet
- T1/E1 Secondary Protection
- T3/E3 Secondary Protection
- A/V Equipment
- Automotive Ethernet

Functional Block Diagram

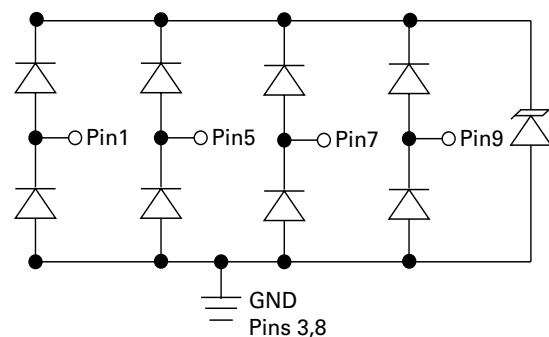

Life Support Note:

Not Intended for Use in Life Support or Life Saving Applications

The products shown herein are not designed for use in life sustaining or life saving applications unless otherwise expressly indicated.

SP4045 Series

Lightning Surge Protection

Absolute Maximum Ratings

Symbol	Parameter	Value	Units
I_{PP}	Peak Current ($t_p=8/20\mu s$)	24	A
P_{PK}	Peak Pulse Power ($t_p=8/20\mu s$)	600	W
T_{OP}	Operating Temperature	-40 to 125	°C
T_{STOR}	Storage Temperature	-55 to 150	°C

Caution: Stresses above those listed in "Absolute Maximum Ratings" may cause permanent damage to the device. This is a stress only rating and operation of the device at these or any other conditions above those indicated in the operational sections of this specification is not implied.

Thermal Information

Parameter	Rating	Units
Storage Temperature Range	-55 to 150	°C
Maximum Junction Temperature	150	°C
Maximum Lead Temperature (Soldering 20-40s)	260	°C

Electrical Characteristics ($T_{OP}=25^\circ C$)

Parameter	Symbol	Test Conditions	Min	Typ	Max	Units
Reverse Standoff Voltage	V_{RWM}				3.3	V
Snap Back Voltage	V_{SB}	$I_{SB}=50mA$	2.8			V
Reverse Leakage Current	I_{LEAK}	$V_R=3.3V$, I/O to GND		0.5	1.0	μA
Clamp Voltage ¹	V_C	$I_{PP}=1A$, $t_p=8/20\mu s$, Fwd		6.0		V
		$I_{PP}=2A$, $t_p=8/20\mu s$, Fwd		7.0		V
Dynamic Resistance ²	R_{DYN}	TLP $t_p=100ns$, Pin 1 to Pin 2		0.3		Ω
ESD Withstand Voltage ¹	V_{ESD}	IEC 61000-4-2 (Contact)	± 30			kV
		IEC 61000-4-2 (Air)	± 30			kV
Diode Capacitance ¹	$C_{I/O-GND}$	Reverse Bias=0V		1.5		pF

Note: 1. Parameter is guaranteed by design and/or device characterization.

2. Transmission Line Pulse (TLP) test setting : Std.TDR(50 Ω), $t_p=100ns$, $t_r=0.2ns$ ITLP and VTLP averaging window: star $t_1=70ns$ to end $t_2=80ns$

8/20 μs Pulse Waveform

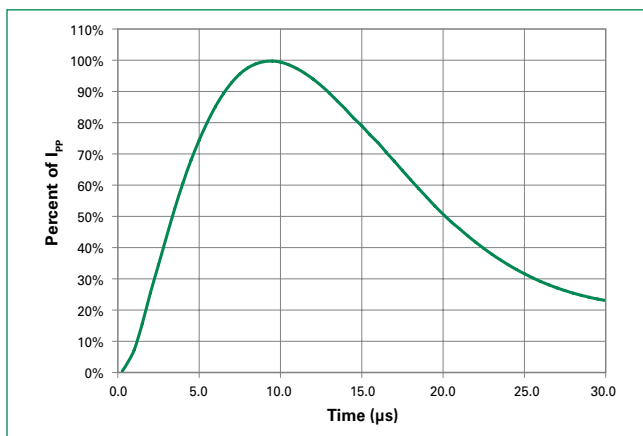

Capacitance vs. Reverse Bias

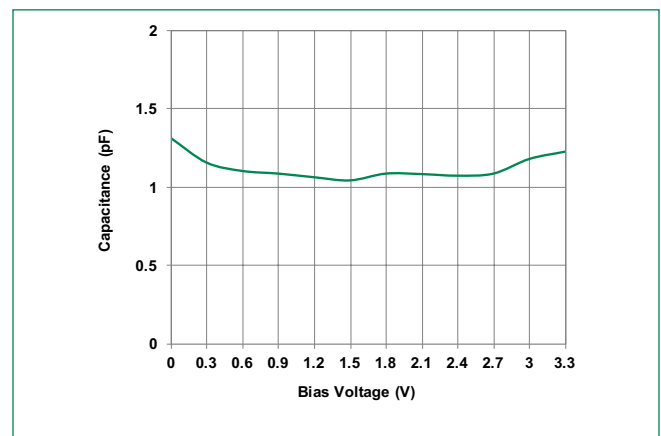

SP4045 Series

Lightning Surge Protection

Clamping Voltage vs. IPP

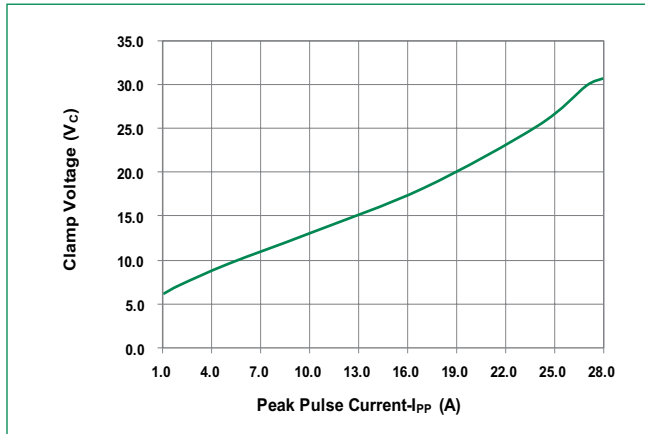

Transmission Line Pulsing (TLP) Plot (Pin 1 to Pin2)

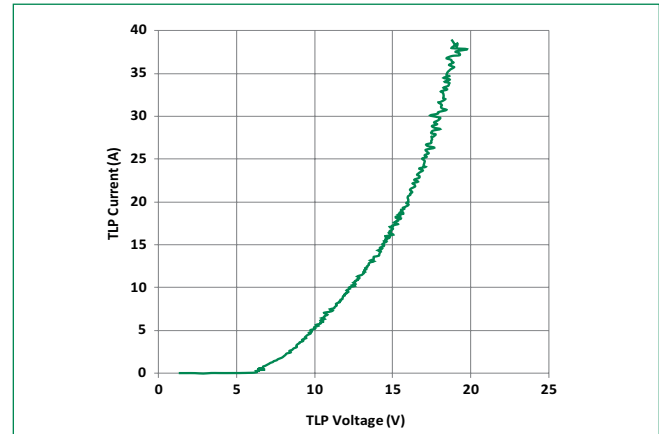

Soldering Parameters

Reflow Condition	Pb – Free assembly	
Pre Heat	- Temperature Min ($T_{s(min)}$)	150°C
	- Temperature Max ($T_{s(max)}$)	200°C
	- Time (min to max) (t_s)	60 – 120 secs
Average ramp up rate (Liquidus) Temp (T_L) to peak	3°C/second max	
$T_{s(max)}$ to T_L - Ramp-up Rate	3°C/second max	
Reflow	- Temperature (T_L) (Liquidus)	217°C
	- Temperature (t_L)	60 – 150 seconds
Peak Temperature (T_p)	260 ^{+0/-5} °C	
Time within 5°C of actual peak Temperature (t_p)	30 seconds	
Ramp-down Rate	6°C/second max	
Time 25°C to peak Temperature (T_p)	8 minutes Max.	
Do not exceed	260°C	

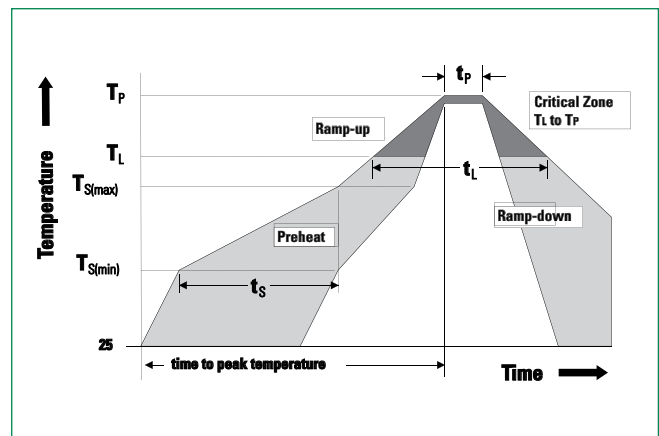

Part Numbering System

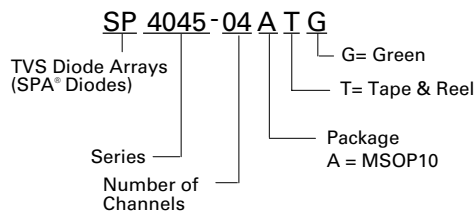

Ordering Information

Part Number	Package	Marking	Min. Order Qty.
SP4045-04ATG	MSOP-10	ⒺH4	4000

Product Characteristics

Lead Plating	Pre-Plated Frame
Lead Material	Copper Alloy
Lead Coplanarity	0.0004 inches (0.102mm)
Substrate material	Silicon
Body Material	V-0 per UL 94 Molded Epoxy

Notes :

- All dimensions are in millimeters
- Dimensions include solder plating.
- Dimensions are exclusive of mold flash & metal burr.
- Blo is facing up for mold and facing down for trim/form, i.e. reverse trim/form.
- Package surface matte finish VDI 11-13.

Part Marking System

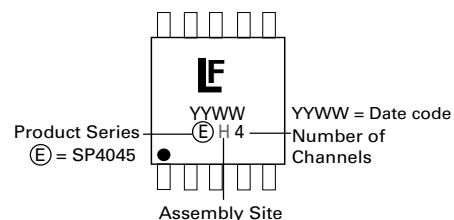

SP4045 Series

Lightning Surge Protection

Package Dimensions – MSOP-10

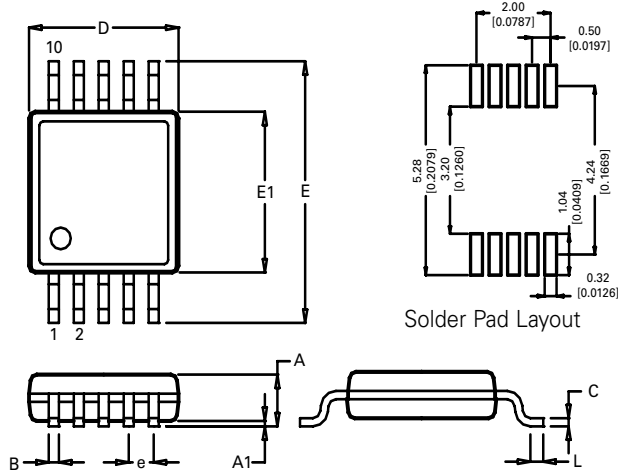

Package	MSOP			
Pins	10			
JEDEC	MO-187			
	Millimeters		Inches	
DIM	Min	Max	Min	Max
A	-	1.10	-	0.043
A1	0.00	0.15	0.000	0.006
B	0.17	0.27	0.007	0.011
c	0.08	0.23	0.003	0.009
D	2.90	3.10	0.114	0.122
E	4.67	5.10	0.184	0.200
E1	2.90	3.10	0.114	0.122
e	0.50 BSC		0.020 BSC	
L	0.40	0.80	0.016	0.032

Embossed Carrier Tape & Reel Specification – MSOP-10

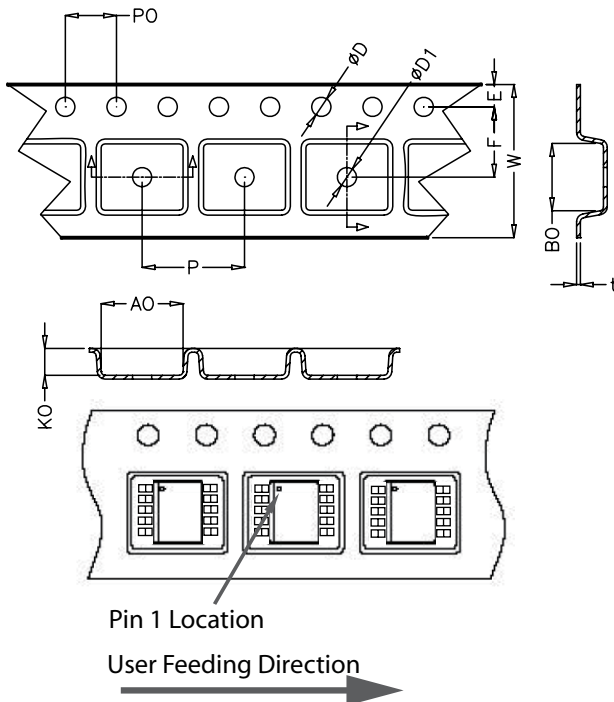

	Millimetres		Inches	
	Min	Max	Min	Max
E	1.65	1.85	0.065	0.073
F	5.40	5.60	0.213	0.220
D	1.50	1.60	0.059	0.063
D1	1.50 Min		0.059 Min	
P0	3.90	4.10	0.154	0.161
W	11.70	12.30	0.460	0.484
P	7.90	8.10	0.311	0.319
A0	5.20	5.40	0.205	0.213
B0	3.20	3.50	0.126	0.138
K0	1.20	1.50	0.047	0.059
t	0.30 +/- 0.05		0.012 +/- 0.002	

Disclaimer Notice - Information furnished is believed to be accurate and reliable. However, users should independently evaluate the suitability of and test each product selected for their own applications. Littelfuse products are not designed for, and may not be used in, all applications. Read complete Disclaimer Notice at www.littelfuse.com/disclaimer-electronics.