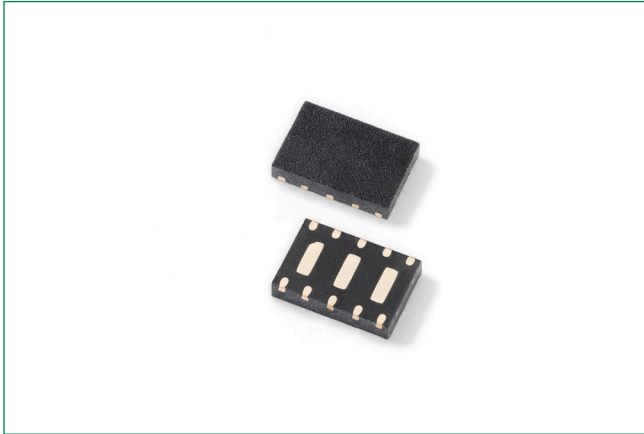
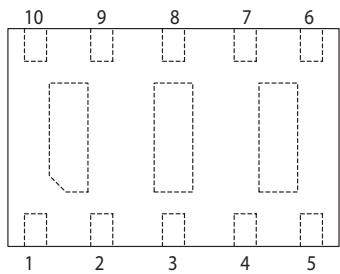
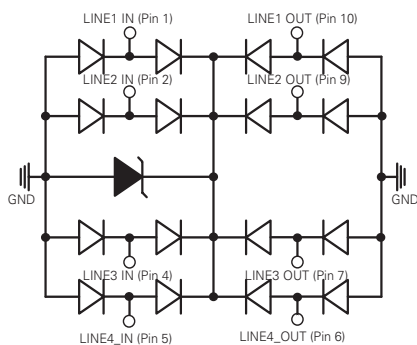

# SP2555NUTG Series

## Lightning Surge Protection

**HF** **RoHS** **Pb**

**Pinout**

**Functional Block Diagram**

## Description

The SP2555NUTG is a low-capacitance, TVS Diode Array designed to provide protection against ESD (electrostatic discharge), CDE (cable discharge events), EFT (electrical fast transients), and lightning induced surges for high-speed, differential data lines. It's packaged in a  $\mu$ DFN package (3.0 x 2.0mm) and each component can protect up to 4 channels or 2 differential pairs, up to 45A (IEC 61000-4-5 2nd edition,) and up to 30kV ESD (IEC 61000-4-2). The "flow-through" design minimizes signal distortion, reduces voltage overshoot, and provides a simplified PCB design.

The SP2555NUTG with its low capacitance and low clamping voltage makes it ideal for high-speed data interfaces such as 1GbE applications found in notebooks, switches, etc.

## Features & Benefits

- ESD, IEC 61000-4-2,  $\pm$ 30kV contact,  $\pm$ 30kV air
- EFT, IEC 61000-4-4, 40A (5/50ns)
- Lightning, IEC 61000-4-5 2nd Edition, 45A (8/20 $\mu$ s)
- Low capacitance of 2.5pF@0V (TYP) per I/O
- Low leakage current of 0.1 $\mu$ A (TYP) at 2.5V
- $\mu$ DFN-10 package is optimized for high-speed data line routing
- Provides protection for two differential data pairs (4 channels) up to 45A
- Low operating and clamping voltage
- AEC-Q101 qualified
- Halogen free, Lead free and RoHS compliant

## Applications

- 10/100/1000 Ethernet
- WAN/LAN Equipment
- Desktops, Servers and Notebooks
- LVDS Interfaces
- Integrated Magnetics
- Smart TV

## Application Example

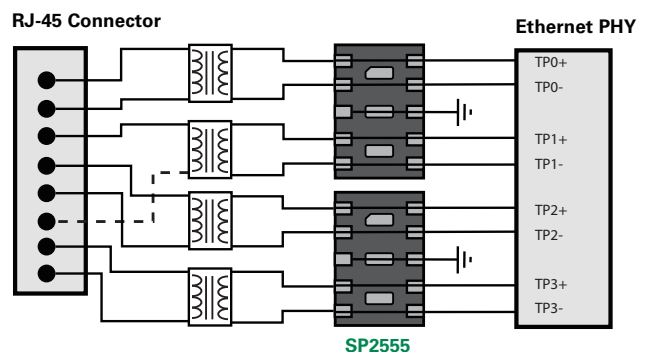

Life Support Note:

**Not Intended for Use in Life Support or Life Saving Applications**

The products shown herein are not designed for use in life sustaining or life saving applications unless otherwise expressly indicated.

# SP2555NUTG Series

## Lightning Surge Protection

### Absolute Maximum Ratings

| Symbol     | Parameter                            | Value      | Units |
|------------|--------------------------------------|------------|-------|
| $I_{PP}$   | Peak Current ( $t_p=8/20\mu s$ )     | 45         | A     |
| $P_{PK}$   | Peak Pulse Power ( $t_p=8/20\mu s$ ) | 1000       | W     |
| $T_{OP}$   | Operating Temperature                | -40 to 125 | °C    |
| $T_{STOR}$ | Storage Temperature                  | -55 to 150 | °C    |

**Caution:** Stresses above those listed in "Absolute Maximum Ratings" may cause permanent damage to the component. This is a stress only rating and operation of the component at these or any other conditions above those indicated in the operational sections of this specification is not implied.

### Electrical Characteristics ( $T_{OP}=25^\circ C$ )

| Parameter                       | Symbol                   | Test Conditions  | Min      | Typ | Max | Units    |
|---------------------------------|--------------------------|--|----------|-----|-----|----------|
| Reverse Standoff Voltage        | $V_{RWM}$                | $I_R \leq 1\mu A$  |          |     | 2.5 | V        |
| Reverse Leakage Current         | $I_R$                    | $V_{RWM} = 2.5V, T = 25^\circ C$   |          | 0.1 | 0.5 | $\mu A$  |
| Snap Back Voltage               | $V_{SB}$                 | $I_{SB} = 50mA$  | 2.0      |     |     | V        |
| Clamp Voltage                   | $V_C$                    | $I_{PP} = 1A, t_p = 8/20\mu s$ , Any I/O to Ground   |          | 4.5 |     | V        |
|                                 |                          | $I_{PP} = 10A, t_p = 8/20\mu s$ , Any I/O to Ground  |          | 7.5 |     |          |
|                                 |                          | $I_{PP} = 25A, t_p = 8/20\mu s$ , Any I/O to Ground  |          | 12  |     |          |
|                                 |                          | $I_{PP} = 45A, t_p = 8/20\mu s$ ,<br>Line-to-Line <sup>1</sup> , two I/O Pins<br>connected together on each line |          | 19  |     |          |
| Dynamic Resistance <sup>2</sup> | $R_{DYN}$                | TLP, $t_p=100ns$ , Any I/O to Ground   |          | 0.1 |     | $\Omega$ |
| ESD Withstand Voltage           | $V_{ESD}$                | IEC 61000-4-2 (Contact)  | $\pm 30$ |     |     | kV       |
|                                 |                          | IEC 61000-4-2 (Air)  | $\pm 30$ |     |     | kV       |
| Diode Capacitance               | $C_{I/O \text{ to GND}}$ | Between I/O Pins and Ground<br>$V_R = 0V, f = 1MHz$  |          | 2.5 |     | pF       |
|                                 | $C_{I/O \text{ to I/O}}$ | Between I/O Pins<br>$V_R = 0V, f = 1MHz$   |          | 1.2 |     | pF       |

**Notes:**

- Rating with 2 pins connected together per suggested diagram ( For example, pin1 is connected to pin 10, pin 2 is connected to Pin 9, Pin 4 is connected to pin 7 and pin 5 is connected to pin 6)
- Transmission Line Pulse (TLP) with 100ns width, 2ns rise time, and average window  $t_1=70ns$  to  $t_2=90ns$

# SP2555NUTG Series

## Lightning Surge Protection

**Capacitance vs. Reverse Bias**

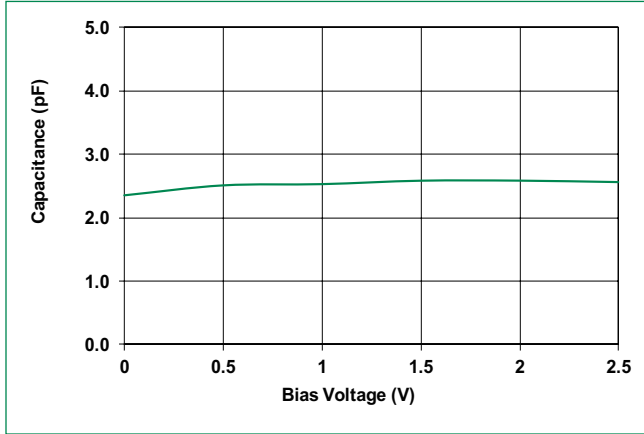

**Clamping Voltage vs.  $I_{pp}$  (I/O to GND)**

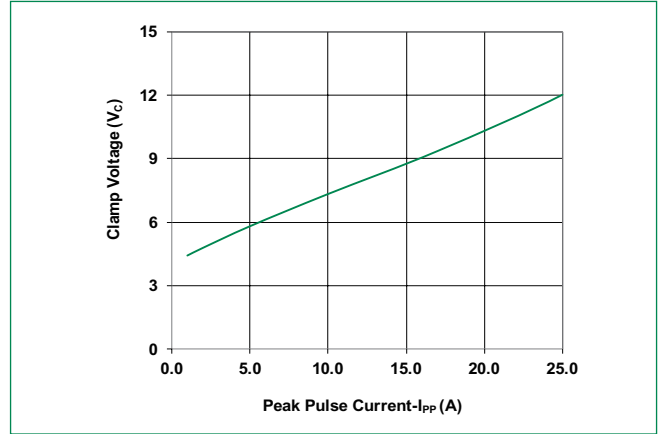

**Clamping Voltage vs.  $I_{pp}$  (Line-to-Line)**

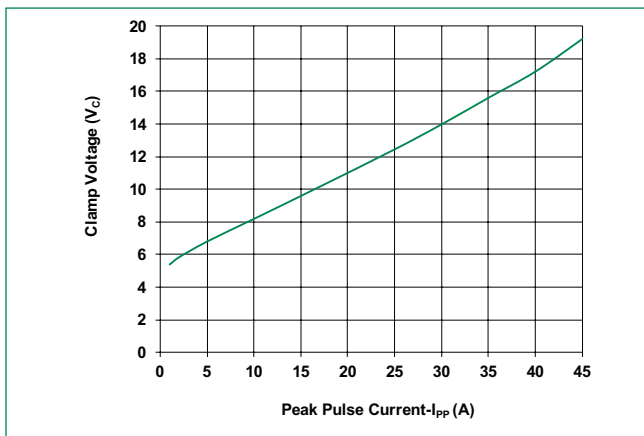

**8/20 $\mu$ S Pulse Waveform**

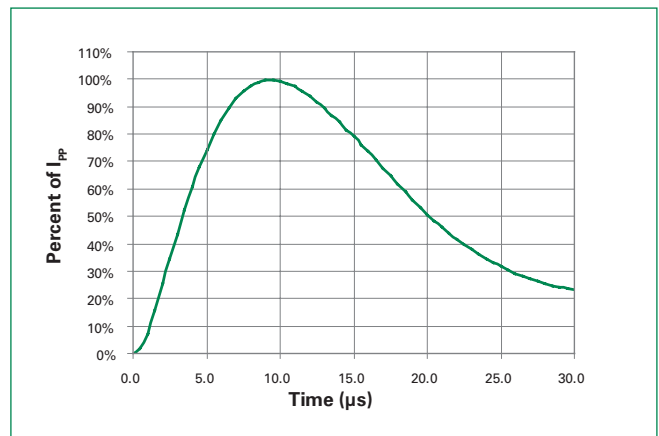

**Transmission Line Pulsing(TLP) Plot**

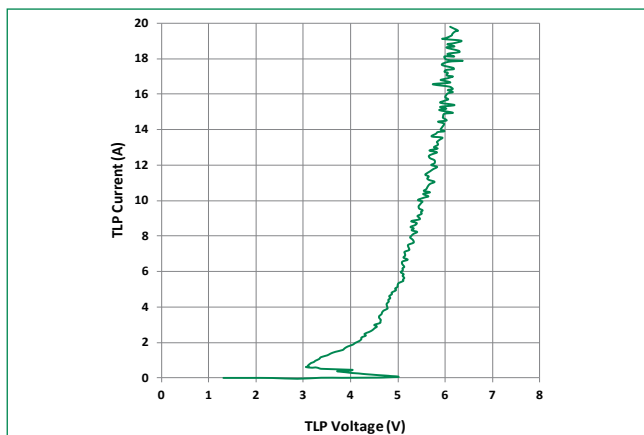

# SP2555NUTG Series

## Lightning Surge Protection

### Soldering Parameters

|  |                                    |                         |
|--|------------------------------------|-------------------------|
| <b>Reflow Condition</b>  |                                    | Pb – Free assembly      |
| <b>Pre Heat</b>  | - Temperature Min ( $T_{s(min)}$ ) | 150°C                   |
|  | - Temperature Max ( $T_{s(max)}$ ) | 200°C                   |
|  | - Time (min to max) ( $t_s$ )      | 60 – 120 secs           |
| <b>Average ramp up rate (Liquidus) Temp (<math>T_L</math>) to peak</b> |                                    | 3°C/second max          |
| <b><math>T_{s(max)}</math> to <math>T_L</math> - Ramp-up Rate</b>      |                                    | 3°C/second max          |
| <b>Reflow</b>  | - Temperature ( $T_L$ ) (Liquidus) | 217°C                   |
|  | - Temperature ( $t_L$ )            | 60 – 150 seconds        |
| <b>Peak Temperature (<math>T_p</math>)</b>                             |                                    | 260 <sup>+0/-5</sup> °C |
| <b>Time within 5°C of actual peak Temperature (<math>t_p</math>)</b>   |                                    | 30 seconds              |
| <b>Ramp-down Rate</b>  |                                    | 6°C/second max          |
| <b>Time 25°C to peak Temperature (<math>T_p</math>)</b>                |                                    | 8 minutes Max.          |
| <b>Do not exceed</b>   |                                    | 260°C                   |

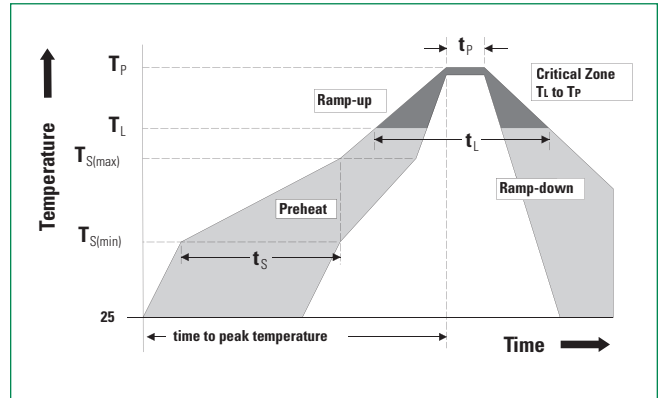

### Ordering Information

| Part Number | Package                | Marking | Min. Order Qty. |
|-------------|------------------------|---------|-----------------|
| SP2555NUTG  | μDFN-10<br>(3.0x2.0mm) | SP2555  | 3000            |

### Part Numbering System

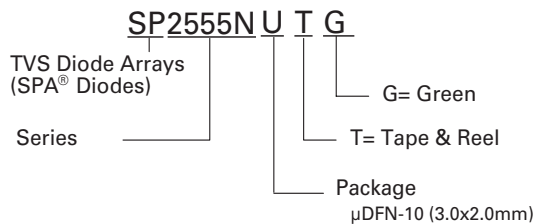

### Part Marking System

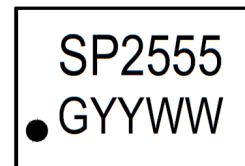

First row= Part Name= SP2555  
Second row= Assembly Code+ Date Code

# SP2555NUTG Series

## Lightning Surge Protection

### Package Dimensions — $\mu$ DFN-10 (3.0x2.0mm)

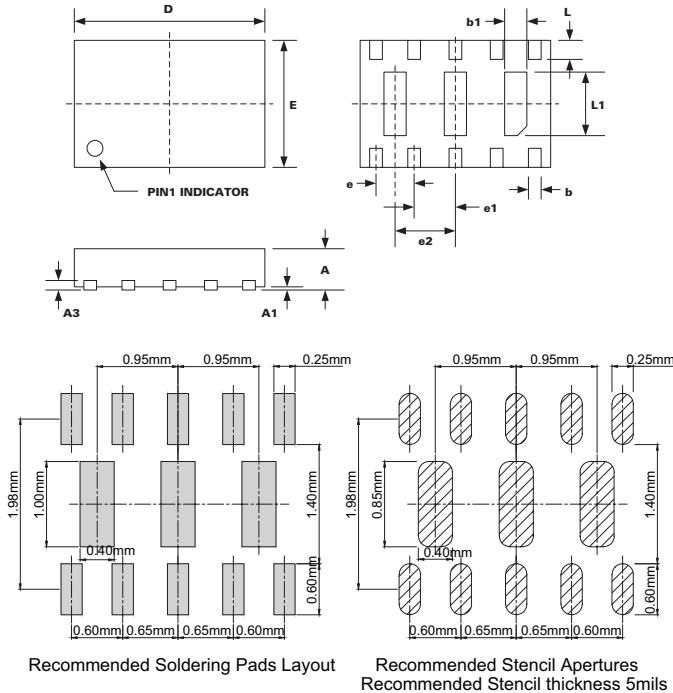

| Package | $\mu$ DFN-10 (3.0x2.0mm) |      |      |           |       |       |
|---------|--------------------------|------|------|-----------|-------|-------|
| JEDEC   | MO-229                   |      |      |           |       |       |
| Symbol  | Millimeters              |      |      | Inches    |       |       |
|         | Min                      | Nom  | Max  | Min       | Nom   | Max   |
| A       | 0.50                     | 0.60 | 0.65 | 0.020     | 0.024 | 0.026 |
| A1      | 0.00                     | 0.03 | 0.05 | 0.000     | 0.001 | 0.002 |
| A3      | 0.15 Ref                 |      |      | 0.006 Ref |       |       |
| b       | 0.15                     | 0.20 | 0.25 | 0.006     | 0.008 | 0.010 |
| b1      | 0.25                     | 0.35 | 0.45 | 0.010     | 0.014 | 0.018 |
| D       | 2.90                     | 3.00 | 3.10 | 0.114     | 0.118 | 0.122 |
| E       | 1.90                     | 2.00 | 2.10 | 0.075     | 0.079 | 0.083 |
| e       | 0.60 BSC                 |      |      | 0.024 BSC |       |       |
| e1      | 0.65 BSC                 |      |      | 0.026 BSC |       |       |
| e2      | 0.95 BSC                 |      |      | 0.037     |       |       |
| L       | 0.25                     | 0.30 | 0.35 | 0.010     | 0.012 | 0.014 |
| L1      | 0.95                     | 1.00 | 1.05 | 0.037     | 0.039 | 0.041 |

#### Notes:

- All dimensions are in millimeters
- Dimensions include solder plating.
- Dimensions are exclusive of mold flash & metal burr.
- Blo is facing up for mold and facing down for trim/form, i.e. reverse trim/form.
- Package surface matte finish VDI 11-13.

### Tape & Reel Specification — $\mu$ DFN-10 (3.0x2.0mm)

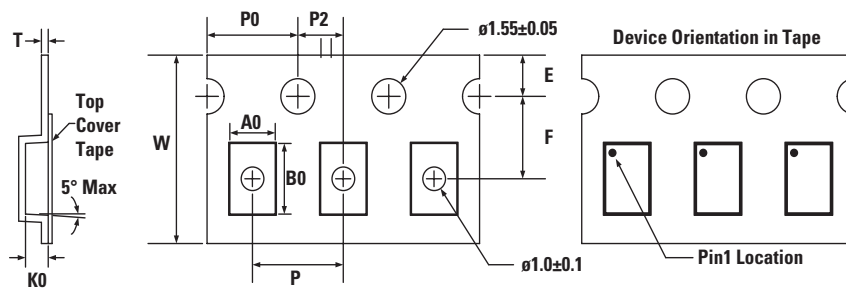

| Package | $\mu$ DFN-10 (3.0x2.0mm) |
|---------|--------------------------|
| Symbol  | Millimeters              |
| A0      | 2.30 +/- 0.10            |
| B0      | 3.20 +/- 0.10            |
| E       | 1.75 +/- 0.10            |
| F       | 3.50 +/- 0.05            |
| K0      | 1.0 +/- 0.10             |
| P       | 4.00 +/- 0.10            |
| P0      | 4.00 +/- 0.10            |
| P2      | 2.00 +/- 0.10            |
| T       | 0.3 +/- 0.05             |
| W       | 8.00 +0.30/- 0.10        |

**Disclaimer Notice** - Information furnished is believed to be accurate and reliable. However, users should independently evaluate the suitability of and test each product selected for their own applications. Littelfuse products are not designed for, and may not be used in, all applications. Read complete Disclaimer Notice at <http://www.littelfuse.com/disclaimer-electronics>.