

SP1326 15pF 30kV Bidirectional Discrete TVS

AUTOMOTIVE GRADE **HF** **RoHS** **GREEN**

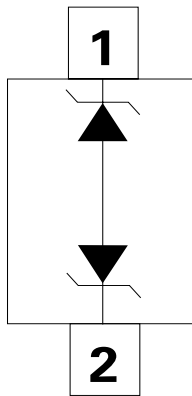

Pinout and Functional Block Diagram



Description

The SP1326 back-to-back diodes are fabricated in a proprietary silicon avalanche technology. These diodes provide a high ESD (electrostatic discharge) protection level for electronic equipment. The SP1326 TVS can safely absorb repetitive ESD strikes at $\pm 30\text{kV}$ (contact and air discharge, IEC 61000-4-2) without performance degradation. Additionally, each diode can safely dissipate 4A of 8/20 μs surge current (IEC 61000-4-5 2nd edition) with very low clamping voltages.

Features

- ESD, IEC 61000-4-2, $\pm 30\text{kV}$ contact, $\pm 30\text{kV}$ air
- EFT, IEC 61000-4-4, 40A (5/50ns)
- Lightning, 4A (8/20 μs as defined in IEC 61000-4-5 2nd edition)
- AEC-Q101 qualified and PPAP capable
- Low leakage current of 0.02 μA (TYP) at 5V
- Space efficient
- Halogen free, Lead free and RoHS compliant
- Moisture Sensitivity Level (MSL -1)

Applications

- Mobile phones
- Smart phones
- Smart watches
- Tablets
- Portable navigation components
- Portable medical components

Application Example

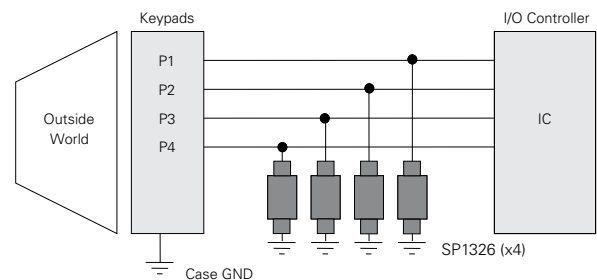

Life Support Note:

Not Intended for Use in Life Support or Life Saving Applications

The products shown herein are not designed for use in life sustaining or life saving applications unless otherwise expressly indicated.

Absolute Maximum Ratings

Symbol	Parameter	Value	Units
I_{PP}	Peak Pulse Current ($t_p=8/20\mu s$)	4	A
T_{OP}	Operating Temperature	-40 to 125	°C
T_{STOR}	Storage Temperature	-55 to 150	°C

CAUTION: Stresses above those listed in "Absolute Maximum Ratings" may cause permanent damage to the component. This is a stress only rating and operation of the component at these or any other conditions above those indicated in the operational sections of this specification is not implied.

Electrical Characteristics ($T_{OP}=25^\circ C$)

Parameter	Symbol	Test Conditions	Min	Typ	Max	Units
Reverse Standoff Voltage	V_{RWM}	$I_R=1\mu A$			6.0	V
Breakdown Voltage	V_{BR}	$I_R=1mA$		7.8		V
Reverse Leakage Current	I_{LEAK}	$V_R=5V$		0.02	0.5	μA
Clamp Voltage ¹	V_C	$I_{PP}=1A, t_p=8/20\mu s, I/O$ to I/O		12.0		V
		$I_{PP}=4A, t_p=8/20\mu s, I/O$ to I/O		15.5		V
Dynamic Resistance ²	R_{DYN}	TLP, $t_p=100ns, I/O$ to I/O		0.35		Ω
ESD Withstand Voltage ¹	V_{ESD}	IEC 61000-4-2 (Contact Discharge)	± 30			kV
		IEC 61000-4-2 (Air Discharge)	± 30			kV
Diode Capacitance ¹	$C_{I/O-I/O}$	Reverse Bias=0V, f=1MHz		15		pF
		Reverse Bias=2.5V, f=1MHz		12		pF

Note:

¹ Parameter is guaranteed by design and/or component characterization.

² Transmission Line Pulse (TLP) with 100ns width, 2ns rise time, and average window $t1=70ns$ to $t2=90ns$

Capacitance vs. Reverse Bias

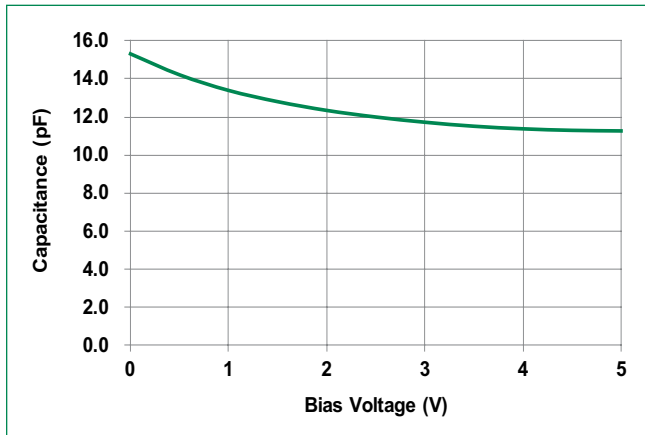

8/20 μs Pulse Waveform

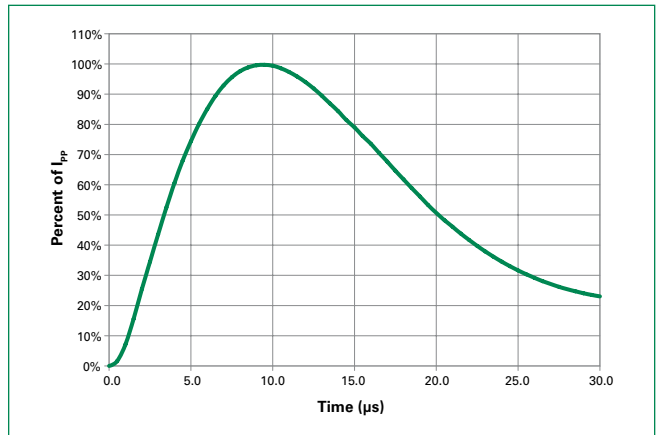

Clamping voltage vs. I_{pp} for 8/20 μ S waveshape

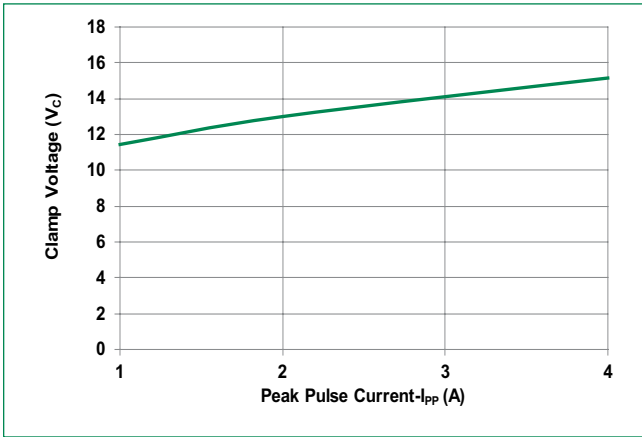

Positive Transmission Line Pulsing (TLP) Plot

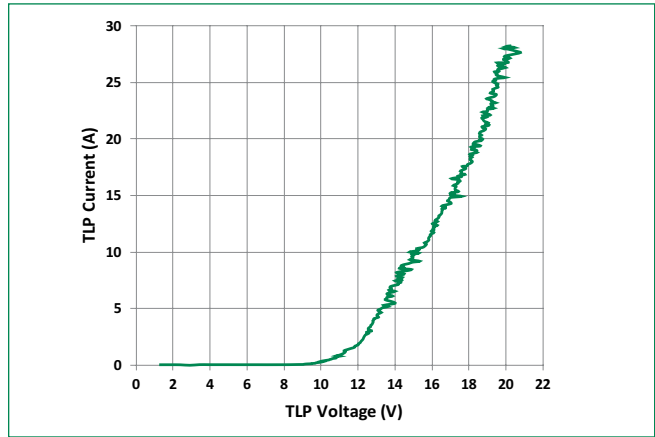

IEC 61000-4-2 +8 kV Contact ESD Clamping Voltage

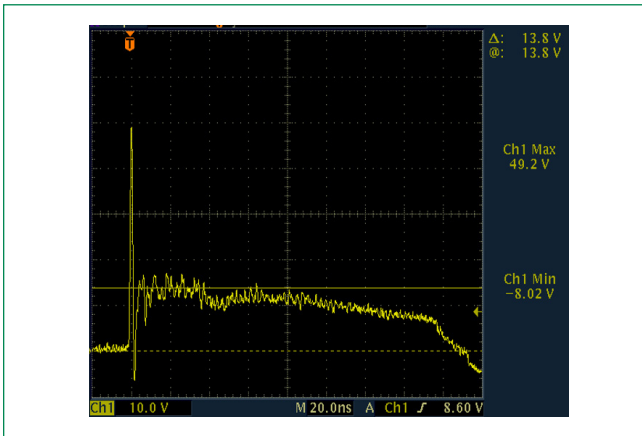

Soldering Parameters

Reflow Condition		Pb – Free assembly
Pre Heat	- Temperature Min ($T_{s(min)}$)	150°C
	- Temperature Max ($T_{s(max)}$)	200°C
	- Time (min to max) (t_s)	60 – 180 secs
Average ramp up rate (Liquidus) Temp (T_L) to peak		3°C/second max
$T_{s(max)}$ to T_L - Ramp-up Rate		3°C/second max
Reflow	- Temperature (T_L) (Liquidus)	217°C
	- Temperature (t_L)	60 – 150 seconds
Peak Temperature (T_p)		260 ^{+0.5} °C
Time within 5°C of actual peak Temperature (t_p)		20 – 40 seconds
Ramp-down Rate		6°C/second max
Time 25°C to peak Temperature (T_p)		8 minutes Max.

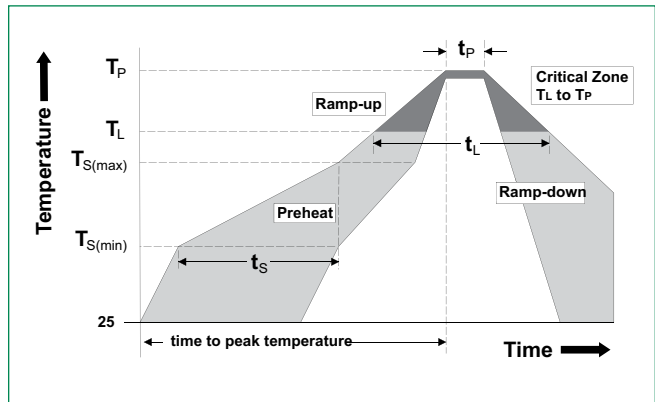

Part Numbering System

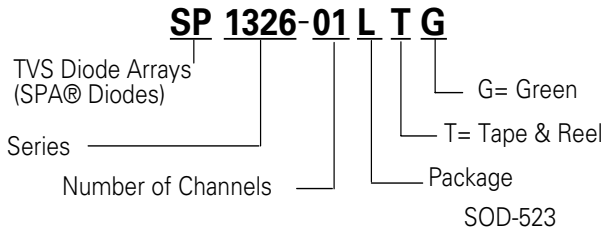

Product Characteristics

Lead Plating	Matte Tin
Lead Material	Copper Alloy
Substrate material	Silicon
Body Material	Molded Compound
Flammability	UL Recognized compound meeting flammability rating V-0.

Ordering Information

Part Number	Package	Min. Order Qty.
SP1326-01LTG	SOD-523	5000

Part Marking System



Package Dimensions – SOD-523

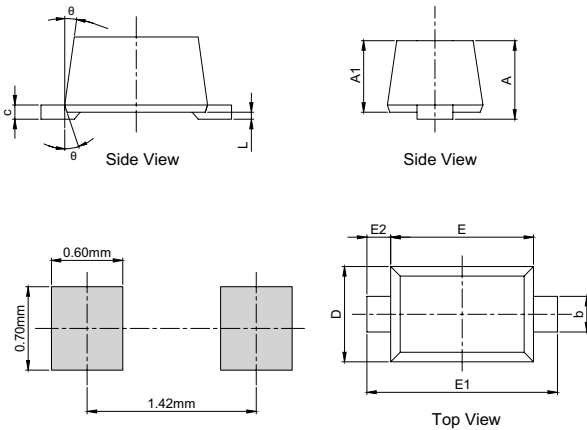

Symbol	Millimeters		Inches	
	Min	Max	Min	Max
A	0.51	0.77	0.020	0.030
A1	0.50	0.70	0.020	0.028
b	0.25	0.35	0.010	0.014
c	0.08	0.15	0.003	0.006
D	0.75	0.85	0.030	0.033
E	1.10	1.30	0.043	0.051
E1	1.50	1.70	0.059	0.067
E2	0.20 REF		0.001 REF	
L	0.01	0.07	0.000	0.003
Ø	7° REF		7° REF	

Embossed Carrier Tape & Reel Specification – SOD-523

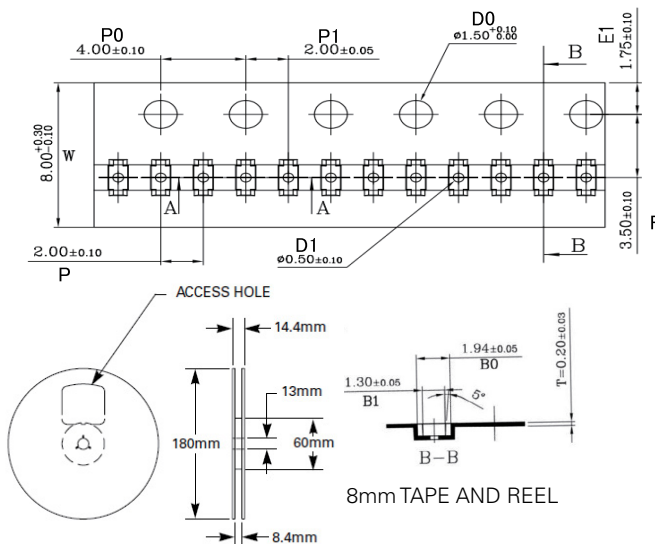

Symbol	Millimetres		Inches	
	Min	Max	Min	Max
A0	0.91	1.01	0.036	0.040
B0	1.89	1.99	0.074	0.078
D0	1.50	1.60	0.059	0.063
D1	0.40	0.60	0.016	0.024
E1	1.65	1.85	0.065	0.073
F	3.40	3.60	0.134	0.142
P0	3.90	4.10	0.154	0.161
P	1.90	2.10	0.075	0.083
P1	1.95	2.05	0.077	0.081
K0	0.68	0.78	0.027	0.031
T	0.17	0.23	0.007	0.009
W	7.90	8.30	0.311	0.327

Disclaimer Notice - Information furnished is believed to be accurate and reliable. However, users should independently evaluate the suitability of and test each product selected for their own applications. Littelfuse products are not designed for, and may not be used in, all applications. Read complete Disclaimer Notice at <http://www.littelfuse.com/disclaimer-electronics>.