

SP1050 Series

Power-over-Ethernet PSE Protection

OBSOLETE DATE: 12/31/2022 PCN/ECN# ESU270-77
REPLACED BY: N/A

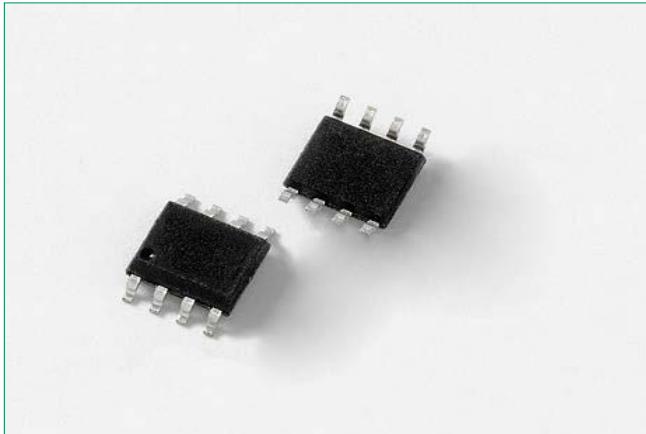

Additional Information



Resources



Accessories



Samples

Functional Block Diagram

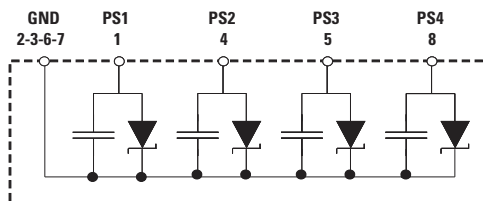

Absolute Maximum Ratings

Parameter	Rating	Units
Peak Pulse Current (8/20 μ s)	24	A
Peak Pulse Power (8/20 μ s)	2700	W
IEC 61000-4-2, Contact Discharge, (Level 4)	30	kV
IEC 61000-4-2, Air Discharge, (Level 4)	30	kV

Caution: Stresses above those listed in "Absolute Maximum Ratings" may cause permanent damage to the component. This is a stress only rating and operation of the component at these or any other conditions above those indicated in the operational sections of this specification is not implied.

Description

The SP1050-04BTG provides over-voltage protection for Power-over-Ethernet PSE equipment in a space saving SOIC-8 package. It incorporates four TVS Diodes each with their own decoupling capacitor to stabilize power supplies.

The SP1050 Series is compatible with the older IEEE 803.af and IEEE 802.3at PoE requirements for Mode A or Mode B for both PSE and PD but is not compatible with the new IEEE 802.3bt (4 wire-pair simultaneous powering) PSE/PD Class 5 through Class 8 or other 4 wire-pair simultaneous powering schemes that implement independent sources for each two wire-pair interface.

It will protect two wire-pair interfaces that share a common grounding from lightning induced surges as outlined in IEC 61000-4-5 2ND Edition, EFTs (electrically fast transients) as outlined in IEC 61000-4-5, and ± 30 kV ESD air and contact discharges as outlined in IEC 61000-4-2.

The low clamping voltage of 96V(Max) makes it compatible with PSE controller technologies

Features & Benefits

- Peak pulse power: up to 2.7 kW (8/20 μ s)
- Lightning, 24A (8/20 as defined in IEC 61000-4-5 2nd edition)
- ESD protection of ± 30 kV contact discharge, ± 30 kV air discharge, (IEC 61000-4-2)
- Stand-off voltage of 58 V
- Low clamping voltage of 96V (MAX) at 24A
- Low leakage current of 0.1 μ A at 25 °C and 1 μ A at 85 °C
- Operating Tj max: 150 °C
- JEDEC registered package outline
- Embeds four decoupling capacitors
- Meets the most stringent environmental conditions
- RoHS compliant and lead-free
- Moisture Sensitivity Level(MSL -1)
- AEC-Q101 qualified

Applications

- PoE (Power over Ethernet)

Life Support Note:

Not Intended for Use in Life Support or Life Saving Applications

The products shown herein are not designed for use in life sustaining or life saving applications unless otherwise expressly indicated.

SP1050 Series

Power-over-Ethernet PSE Protection

Electrical Characteristics ($T_{OP} = 25^{\circ}\text{C}$)

Parameter	Symbol	Test Conditions	Min	Typ	Max	Units
Leakage Current	I_{RM}	$25^{\circ}\text{C}, V_{PoE} = 58\text{V}$	-	-	0.1	μA
		$85^{\circ}\text{C}, V_{PoE} = 58\text{V}^1$	-	-	1	μA
Breakdown Voltage	V_{BR}	$I_R = 1\text{mA}$	64	67	-	V
Clamping Voltage ²	V_C	$I_{PP} = 24\text{A}, t_p = 8/20\ \mu\text{s}$	-	-	96	V
Dynamic Resistance ²	R_{DYN}	TLP, $t_p = 100\text{ns}$, I/O to GND ²	-	0.35	-	Ω
Capacitance ¹	C	$V_{PoE} = 58\text{V}$	-	35	-	pF

Notes:

- Parameter is guaranteed by design and/or component characterization.
- Transmission Line Pulse (TLP) with 100ns width, 2ns rise time, and average window $t_1 = 70\text{ns}$ to $t_2 = 90\text{ns}$

8/20 μs Pulse Waveform

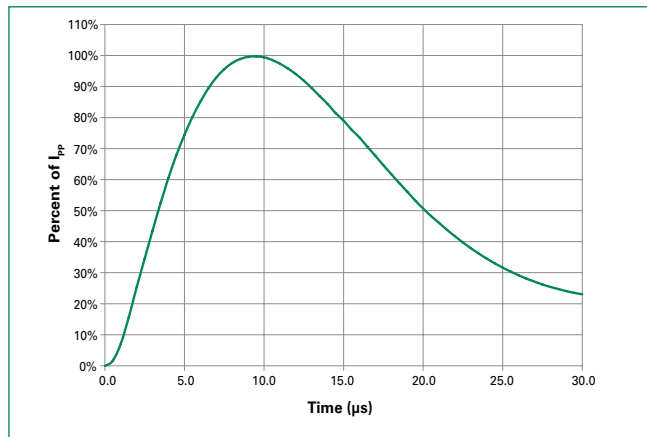

Capacitance vs. Reverse Bias

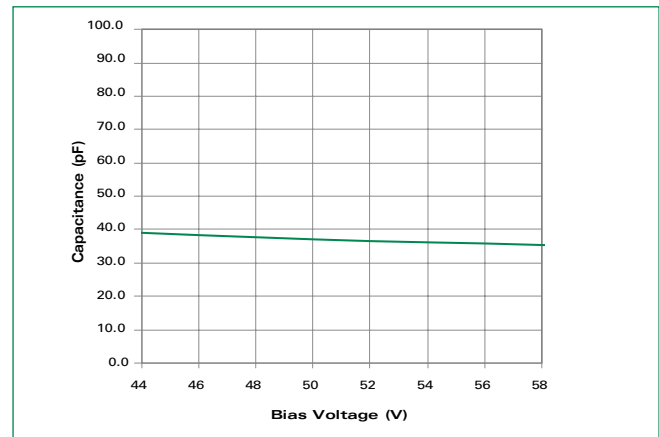

Clamping Voltage vs IPP

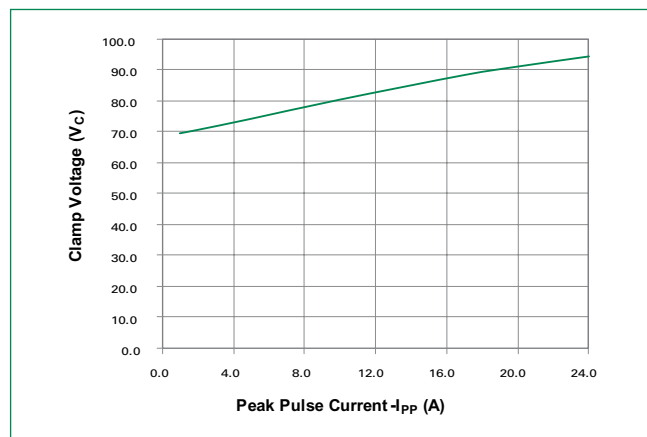

Non-Repetitive Peak Pulse Power vs. Pulse Time

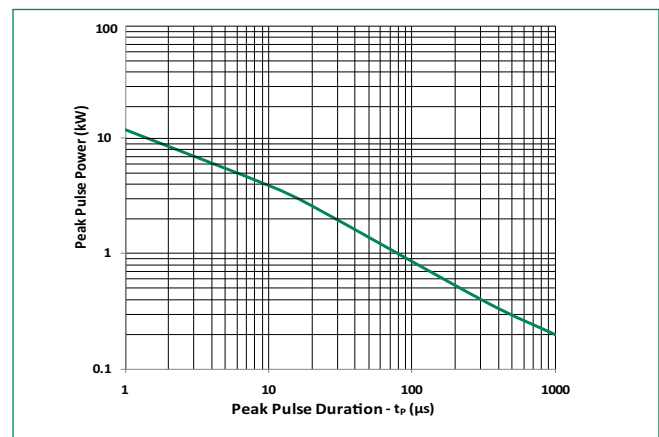

SP1050 Series

Power-over-Ethernet PSE Protection

Transmission Line Pulse (TLP)

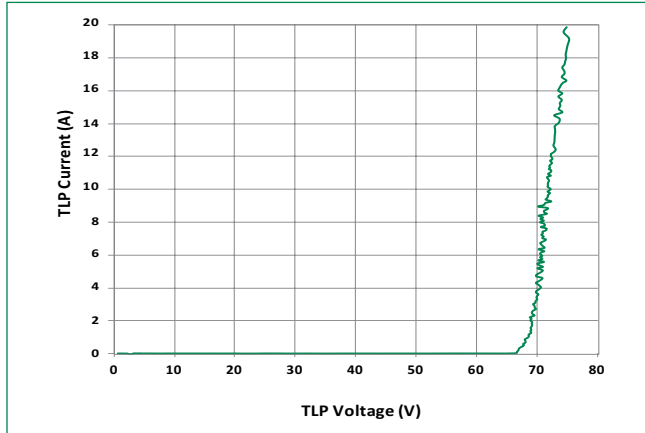

Soldering Parameters

Reflow Condition		Pb – Free assembly
Pre Heat	- Temperature Min ($T_{s(min)}$)	150°C
	- Temperature Max ($T_{s(max)}$)	200°C
	- Time (min to max) (t_s)	60 – 180 secs
Average ramp up rate (Liquidus) Temp (T_L) to peak		3°C/second max
$T_{s(max)}$ to T_L - Ramp-up Rate		3°C/second max
Reflow	- Temperature (T_L) (Liquidus)	217°C
	- Temperature (t_L)	60 – 150 seconds
Peak Temperature (T_p)		260 ^{+0/-5} °C
Time within 5°C of actual peak Temperature (t_p)		20 – 40 seconds
Ramp-down Rate		6°C/second max
Time 25°C to peak Temperature (T_p)		8 minutes Max.
Do not exceed		260°C

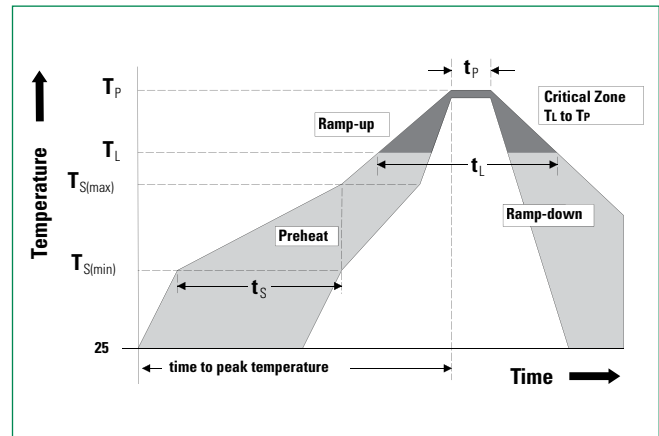

Product Characteristics

Lead Plating	Tin
Lead Material	Alloy 42
Lead Coplanarity	0.0004 inches (0.102mm)
Substrate Material	Silicon
Body Material	Molded Compound
Flammability	UL Recognized compound meeting flammability rating V-0

SP1050 Series

Power-over-Ethernet PSE Protection

Application Schematic

Figure 1: Typical application circuit with fully integrated PSE controller

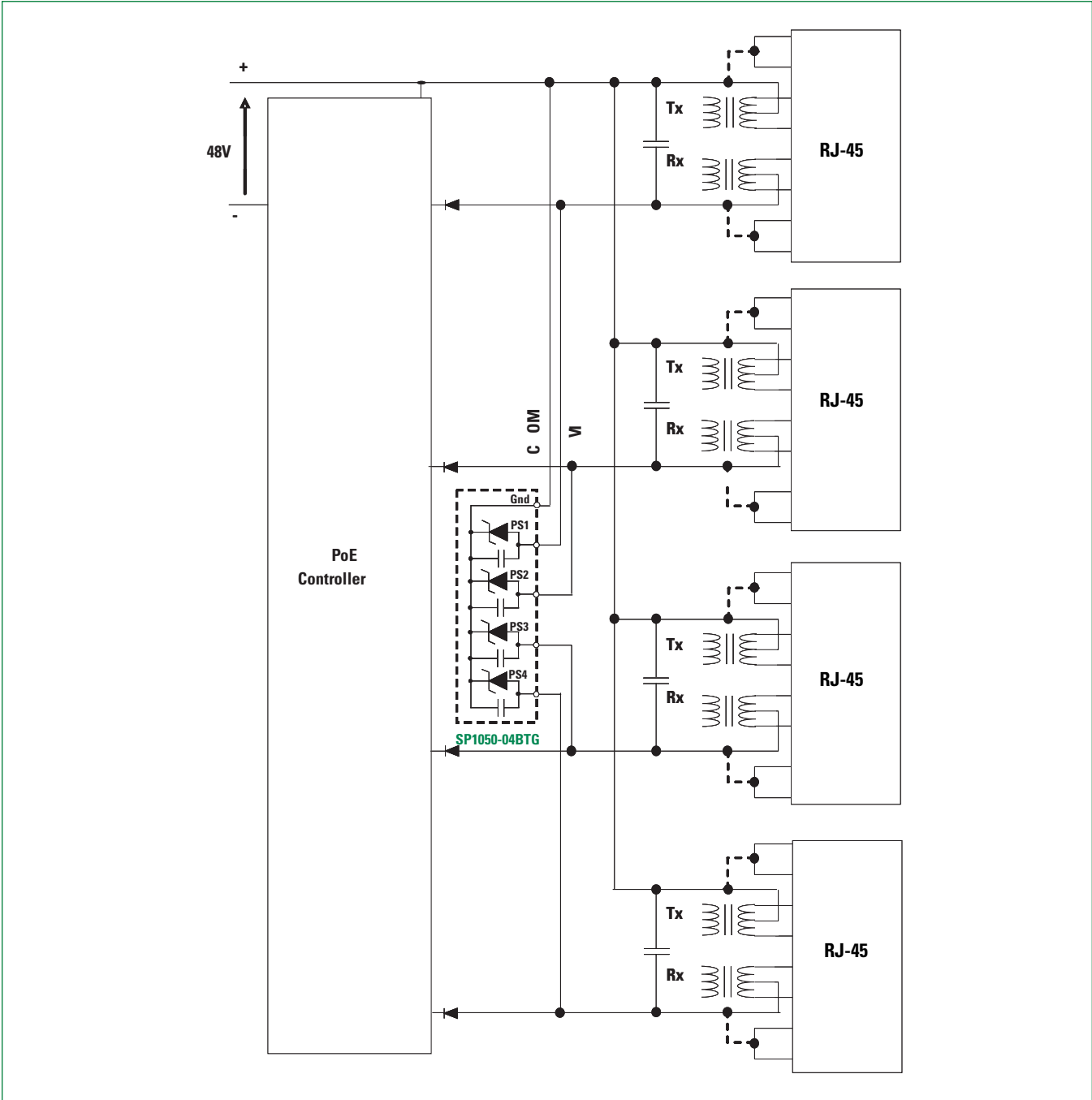
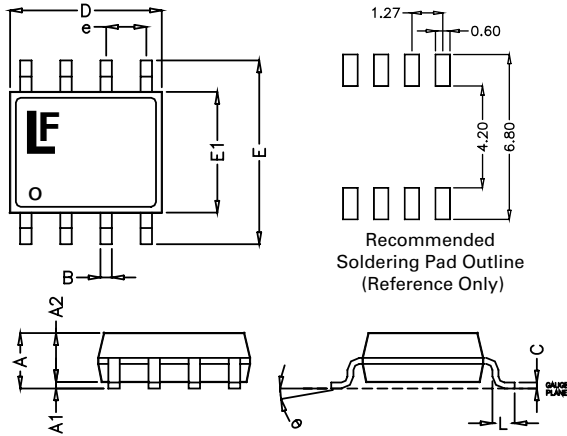

Figure 1 shows typical application of power sourcing equipment (PSE) allowing communication and power sourcing for several powered devices (PD). The SP1050-04BTG is optimized for space savings as there is generally a multiple of 4 present. This protection component complies with IEEE 802.3af and IEEE 802.3at (also known as PoE+). This component should be compatible with level 4/5 surge requirements of IEC 61000-4-5 since it is located on the secondary side of the coupling transformer, but lab testing should be conducted to confirm.

SP1050 Series

Power-over-Ethernet PSE Protection

Package Dimensions of SOIC-8



Package	SOIC			
Pins	8			
JEDEC	MS-012			
	Millimetres		Inches	
	Min	Max	Min	Max
A	1.35	1.75	0.053	0.069
A1	0.10	0.25	0.004	0.010
A2	1.25	1.65	0.050	0.065
B	0.31	0.51	0.012	0.020
c	0.17	0.25	0.007	0.010
D	4.80	5.00	0.189	0.197
E	5.80	6.20	0.228	0.244
E1	3.80	4.00	0.150	0.157
e	1.27 BSC		0.050 BSC	
L	0.40	1.27	0.016	0.050

Embossed Carrier Tape & Reel Specification — SOIC Package

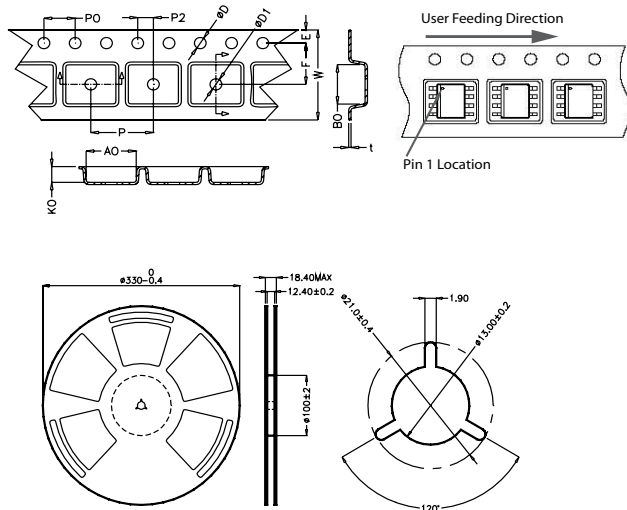

	Millimetres		Inches	
	Min	Max	Min	Max
E	1.65	1.85	0.065	0.073
F	5.4	5.6	0.213	0.22
P2	1.95	2.05	0.077	0.081
D	1.5	1.6	0.059	0.063
D1	1.50 Min		0.059 Min	
P0	3.9	4.1	0.154	0.161
10P0	40.0 +/- 0.20		1.574 +/- 0.008	
W	11.9	12.1	0.468	0.476
P	7.9	8.1	0.311	0.319
A0	6.3	6.5	0.248	0.256
B0	5.1	5.3	0.2	0.209
K0	2	2.2	0.079	0.087
t	0.30 +/- 0.05		0.012 +/- 0.002	

Part Numbering System

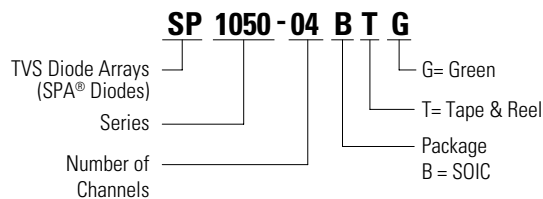

Ordering Information

Part Number	Package	Min. Order Qty.
SP1050-04BTG	SOIC Tape & Reel	2500

Disclaimer Notice - Information furnished is believed to be accurate and reliable. However, users should independently evaluate the suitability of and test each product selected for their own applications. Littelfuse products are not designed for, and may not be used in, all applications. Read complete Disclaimer Notice at: www.littelfuse.com/disclaimer-electronics.