

SC1333-01ETG Series

General Purpose ESD Protection

HF RoHS Pb



Pinout

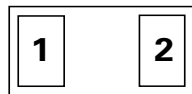

Functional Block Diagram

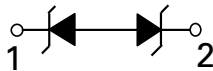

Description

The SC1333-01ETG back-to-back diodes are fabricated in a proprietary silicon avalanche technology. These diodes provide a high ESD (electrostatic discharge) protection level for electronic equipment. The SC1333-01ETG TVS can safely absorb repetitive ESD strikes at the maximum level specified in the IEC 61000-4-2 international standard (Level 4, $\pm 8\text{kV}$ contact discharge) without performance degradation. The back-to-back configuration provides symmetrical ESD protection for data lines. Additionally, the SC1333-01ETG offers up to 5A 8/20 μs surge rating with low clamping voltages.

Features & Benefits

- ESD, IEC 61000-4-2, $\pm 30\text{kV}$ contact, $\pm 30\text{kV}$ air
- EFT, IEC 61000-4-4, 40A (5/50ns)
- Lightning, IEC 61000-4-5, 2nd Edition, 5A (8/20 μs)
- Low capacitance of 8pF (TYP @ VR=0V)
- Low leakage current of 1nA (TYP) at 3.3V
- Space Efficient 0402
- Halogen free, Lead free and RoHS compliant
- Moisture Sensitivity Level (MSL -1)

Applications

- Mobile Phones
- Smart Phones
- Portable Medical
- MP3/PMP
- Portable Navigation Components
- Tablets
- Small Size Panel
- Point of Sale Terminals

Life Support Note:

Not Intended for Use in Life Support or Life Saving Applications

The products shown herein are not designed for use in life sustaining or life saving applications unless otherwise expressly indicated.

SC1333-01ETG Series

General Purpose ESD Protection

Absolute Maximum Ratings

Symbol	Parameter	Value	Units
I_{PP}	Peak Current ($t_p=8/20\mu s$)	5	A
T_{OP}	Operating Temperature	-40 to 125	°C
T_{STOR}	Storage Temperature	-55 to 150	°C

Caution: Stresses above those listed in "Absolute Maximum Ratings" may cause permanent damage to the component. This is a stress only rating and operation of the component at these or any other conditions above those indicated in the operational sections of this specification is not implied.

Electrical Characteristics ($T_{OP}=25^{\circ}C$)

Parameter	Symbol	Test Conditions	Min	Typ	Max	Units
Reverse Standoff Voltage	V_{RWM}	$I_R=1\mu A$			3.3	V
Breakdown Voltage	V_{BR}	$I_R=1mA$	3.5	4.5		V
Reverse Leakage Current	I_{LEAK}	$V_R=3.3V$		1	50	nA
Clamp Voltage ¹	V_C	$I_{PP}=1A, t_p=8/20\mu s, I/O$ to I/O		5	7	V
		$I_{PP}=5A, t_p=8/20\mu s, I/O$ to I/O		7.5	9	V
Dynamic Resistance ²	R_{DYN}	TLP, $t_p=100ns, I/O$ to I/O		0.3		Ω
ESD Withstand Voltage ¹	V_{ESD}	IEC 61000-4-2 (Contact Discharge)	± 30			kV
		IEC 61000-4-2 (Air Discharge)	± 30			kV
Diode Capacitance ¹	$C_{I/O-I/O}$	Reverse Bias=0V, f=1MHz		8	10	pF

Note:

- Parameter is guaranteed by design and/or component characterization.
- Transmission Line Pulse (TLP) with 100ns width, 2ns rise time, and average window $t1=70ns$ to $t2=90ns$

8/20 μs Pulse Waveform

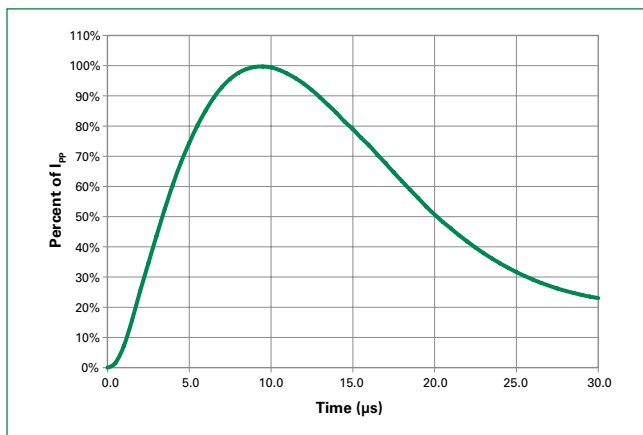

SC1333-01ETG Series

General Purpose ESD Protection

Capacitance vs Reverse Bias

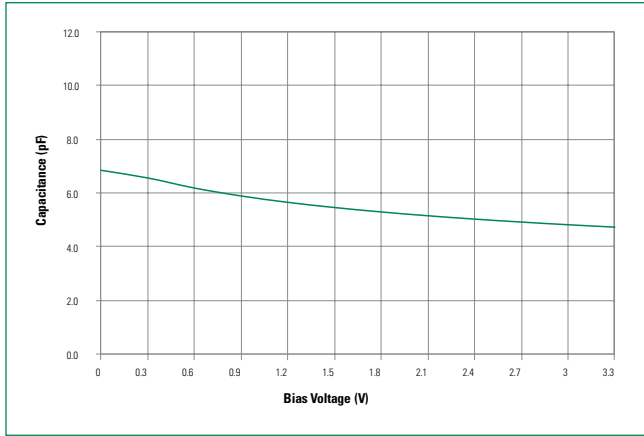

Clamping Voltage vs I_{pp}

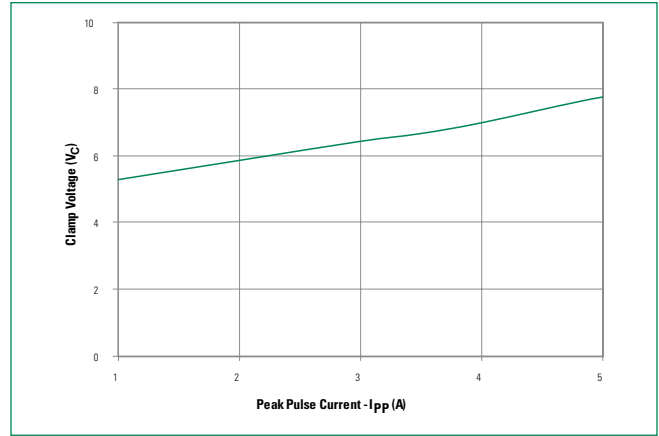

Positive TLP

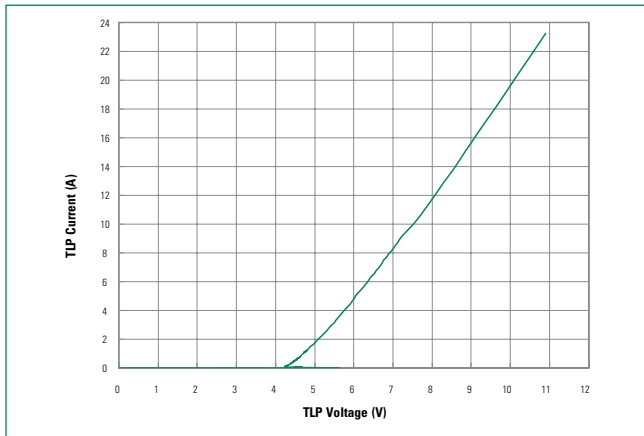

Negative TLP

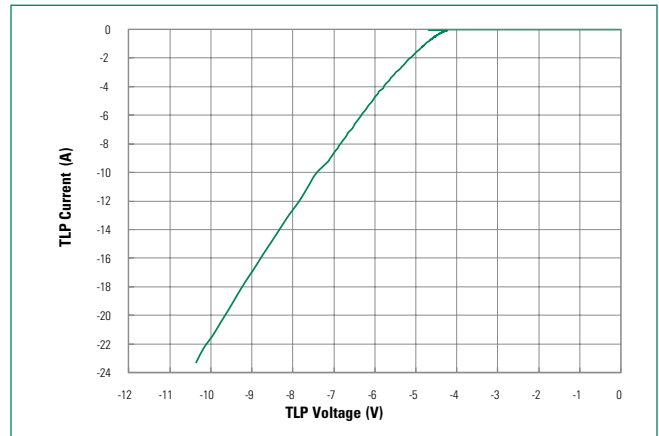

IEC Contact Discharge at +8 kV

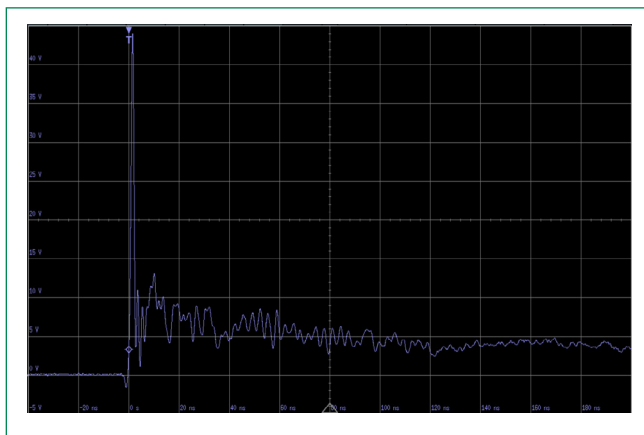

IEC Contact Discharge at -8 kV

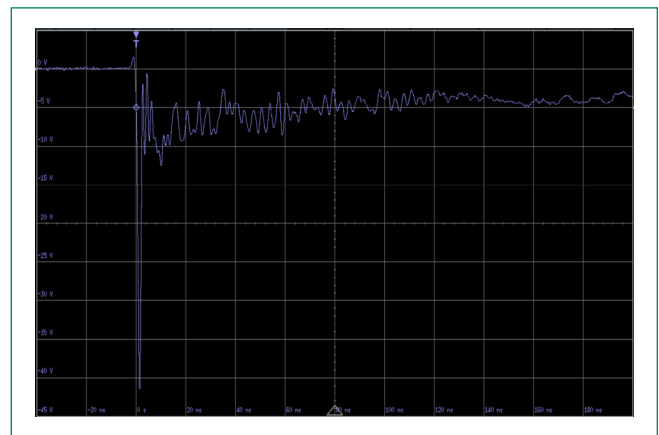

SC1333-01ETG Series

General Purpose ESD Protection

Soldering Parameters

Reflow Condition		Pb – Free assembly
Pre Heat	- Temperature Min ($T_{s(min)}$)	150°C
	- Temperature Max ($T_{s(max)}$)	200°C
	- Time (min to max) (t_s)	60 – 120 secs
Average ramp up rate (Liquidus) Temp (T_L) to peak		3°C/second max
$T_{s(max)}$ to T_L - Ramp-up Rate		3°C/second max
Reflow	- Temperature (T_L) (Liquidus)	217°C
	- Temperature (t_L)	60 – 150 seconds
Peak Temperature (T_p)		260 ^{+0/-5} °C
Time within 5°C of actual peak Temperature (t_p)		30 seconds
Ramp-down Rate		6°C/second max
Time 25°C to peak Temperature (T_p)		8 minutes Max.
Do not exceed		260°C

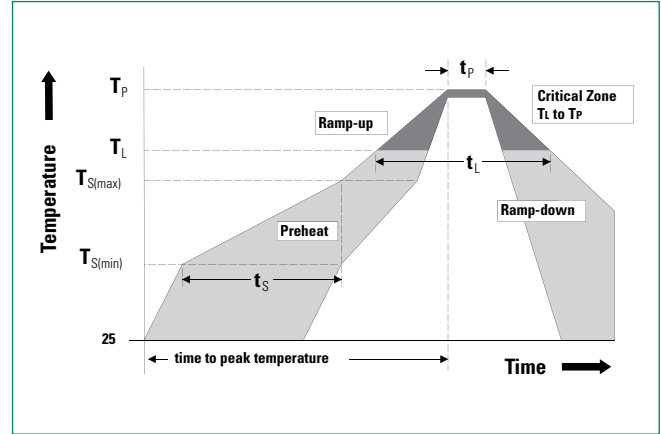

Product Characteristics

Lead Plating	Pre-Plated Frame Matte Tin
Lead material	Copper Alloy
Substrate Material	Silicon
Body Material	Molded Compound
Flammability	UL Recognized compound meeting flammability rating V-0

Ordering Information

Part Number	Package	Min. Order Qty.
SC1333-01ETG	SOD882	10000

Part Marking System

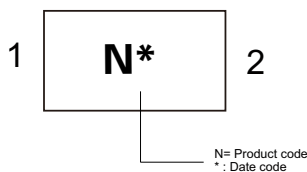

Part Numbering System

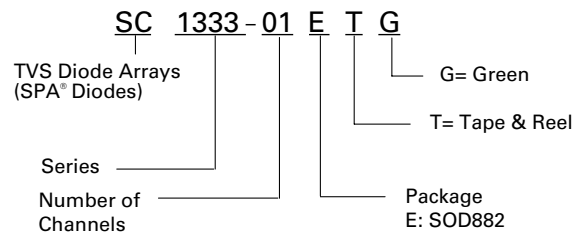

SC1333-01ETG Series

General Purpose ESD Protection

Package Dimensions – SOD882

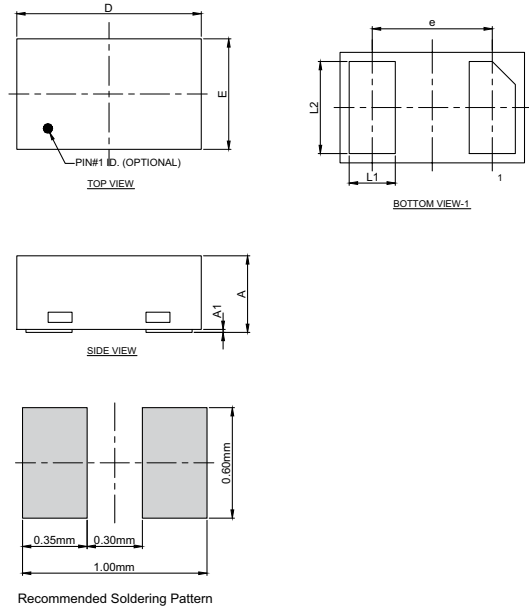

Symbol	SOD882					
	Millimeters			Inches		
	Min	Typ	Max	Min	Typ	Max
A	0.40	0.50	0.55	0.016	0.020	0.022
A1	0.00	0.02	0.05	0.000	0.001	0.002
L1	0.20	0.25	0.30	0.008	0.010	0.012
L2	0.45	0.50	0.55	0.018	0.020	0.022
D	0.95	1.00	1.05	0.037	0.039	0.041
E	0.55	0.60	0.65	0.022	0.024	0.026
e	0.65 BSC			0.026 BSC		

Embossed Carrier Tape & Reel Specification – SOD882

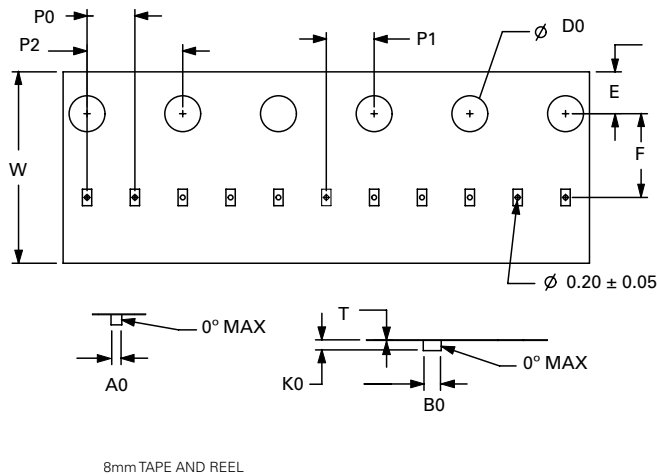

Symbol	Millimeters		Inches	
	Min	Max	Min	Max
A0	0.66	0.78	0.026	0.031
B0	1.07	1.24	0.042	0.049
D0	1.50	1.60	0.059	0.063
E	1.65	1.85	0.065	0.073
F	3.40	3.60	0.134	0.142
K0	0.47	0.66	0.019	0.026
P0	1.90	2.10	0.075	0.083
P1	1.90	2.10	0.075	0.083
P2	3.90	4.10	0.154	0.161
T	0.18	0.25	0.007	0.010
W	7.80	8.20	0.307	0.323

Product Disclaimer: Littelfuse products are not designed for, and shall not be used for, any purpose (including, without limitation, automotive, military, aerospace, medical, life-saving, life-sustaining or nuclear facility applications, devices intended for surgical implant into the body, or any other application in which the failure or lack of desired operation of the product may result in personal injury, death, or property damage) other than those expressly set forth in applicable Littelfuse product documentation. Warranties granted by Littelfuse shall be deemed void for products used for any purpose not expressly set forth in applicable Littelfuse documentation. Littelfuse shall not be liable for any claims or damages arising out of products used in applications not expressly intended by Littelfuse as set forth in applicable Littelfuse documentation. The sale and use of Littelfuse products is subject to Littelfuse Terms and Conditions of Sale, unless otherwise agreed by Littelfuse. "Littelfuse" includes Littelfuse, Inc., and all of its affiliate entities. <http://www.littelfuse.com/disclaimer-electronics>