

# AQ3130E-01ETG

## 28V, 0.3pF, 30kV, SOD882, Bidirectional TVS, Ultra Low Capacitance ESD Protection



### Description

The AQ3130E-01ETG provides ultra-low capacitance, bidirectional and a high level of protection for electronic equipment that may experience destructive electrostatic discharges (ESD). The typical capacitance of 0.3pF helps ensure excellent signal integrity on the most challenging consumer electronics interfaces.

It can safely absorb repetitive ESD strikes at  $\pm 30\text{kV}$  (contact discharge, IEC 61000-4-2) without performance degradation and safely dissipate 3.0A of 8/20 $\mu\text{s}$  surge current (IEC 61000-4-5 2<sup>nd</sup> edition).

### Pinout

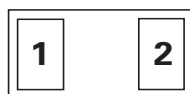

### Functional Block Diagram

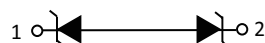

### Features

- ESD, IEC 61000-4-2,  $\pm 30\text{kV}$  contact/air
- ESD, ISO10605 330pF 330 $\Omega$ ,  $\pm 25\text{kV}$  contact,  $\pm 28\text{kV}$  air
- EFT, IEC 61000-4-4, 40A (5/50ns)
- Maximum surge tolerance, IEC 61000-4-5 2<sup>nd</sup> Edition, 3.0A (8/20 $\mu\text{s}$ )
- Ultra low capacitance of 0.3pF(TYP@ $V_R=0\text{V}$ )
- Low leakage current of 1nA (TYP) at 28V
- Halogen-free, lead-free and RoHS compliant
- Moisture Sensitivity Level (MSL-1)
- AEC-Q101 Qualified and PPAP Capable

### Applications

- Automotive
- USB 2.0, USB 3.0
- Near Field Communications
- RF Signal ESD Protection
- RF Switching, Power Amplifier and Antenna ESD Protection

#### Life Support Note:

Not Intended for Use in Life Support or Life Saving Applications

The products shown herein are not designed for use in life sustaining or life saving applications unless otherwise expressly indicated.

# AQ3130E-01ETG

## 28V, 0.3pF, 30kV, SOD882, Bidirectional TVS, Ultra Low Capacitance ESD Protection

### Absolute Maximum Ratings

Symbol	Parameter	Value	Units
$I_{PP}$	Peak Current ( $t_p=8/20\mu s$ )	3.0	A
$T_{OP}$	Operating Temperature	-40 to 150	°C
$T_{STOR}$	Storage Temperature	-55 to 150	°C

**CAUTION:** Stresses above those listed in "Absolute Maximum Ratings" may cause permanent damage to the component. This is a stress only rating and operation of the component at these or any other conditions above those indicated in the operational sections of this specification is not implied.

### Electrical Characteristics ( $T_{OP}=25^\circ C$ )

Parameter	Symbol	Test Conditions	Min	Typ	Max	Units
Reverse Standoff Voltage	$V_{RWM}$				28	V
Breakdown Voltage	$V_{BR}$	$I_R=1mA$	30	35	40	V
Reverse Leakage Current	$I_{LEAK}$	$V_R=28V$		1	50	nA
Clamp Voltage <sup>1</sup>	$V_C$	$I_{PP}=1A$ , $t_p=8/20\mu s$ , I/O to GND		39	44	V
		$I_{PP}=3A$ , $t_p=8/20\mu s$ , I/O to GND		42	48	V
Dynamic Resistance <sup>1,2</sup>	$R_{DYN}$	TLP; $t_p=100ns$ , I/O to GND		0.65		$\Omega$
ESD Withstand Voltage <sup>1,3,4</sup>	$V_{ESD}$	IEC 61000-4-2 (Contact Discharge)	$\pm 30$			kV
		IEC 61000-4-2 (Air Discharge)	$\pm 30$			kV
		ISO10605 (Contact Discharge)	$\pm 25$			kV
		ISO10605 (Air Discharge)	$\pm 28$			kV
Diode Capacitance <sup>1</sup>	$C_{IO-GND}$	Reverse Bias=0V, $f=1MHz$ , I/O to GND		0.30	0.45	pF

**Note:**

- Parameter is guaranteed by design and/or component characterization.
- Transmission Line Pulse (TLP) with 100ns width, 0.2ns rise time, and average window  $t_1=70ns$  to  $t_2=90ns$
- Device stressed with ten non-repetitive ESD pulses according to IEC61000-4-2 ( $R=330\Omega$ ,  $C=150pF$ ).
- Device stressed with three non-repetitive ESD pulses according to ISO10605 ( $R=330\Omega$ ,  $C=330pF$ ).

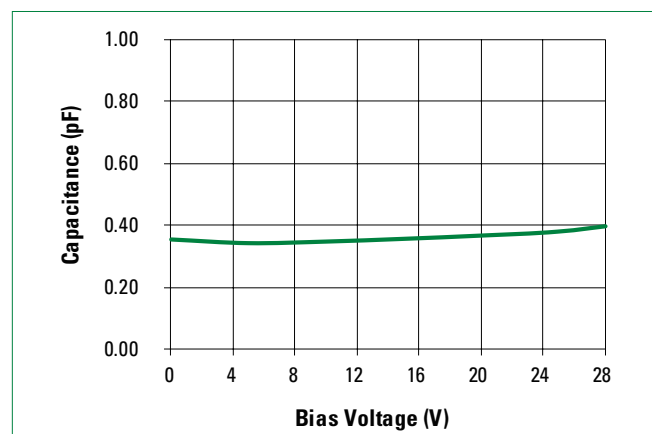
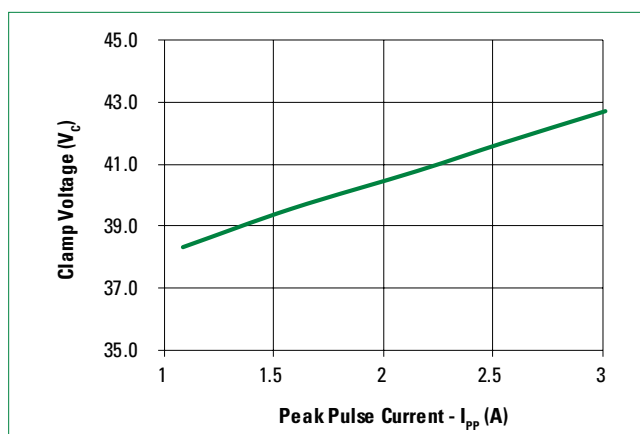
**Capacitance vs. Reverse Bias****Clamping Voltage vs  $I_{PP}$** 

# AQ3130E-01ETG

28V, 0.3pF, 30kV, SOD882, Bidirectional TVS, Ultra Low Capacitance ESD Protection

**Positive Transmission Line Pulsing (TLP) Plot**

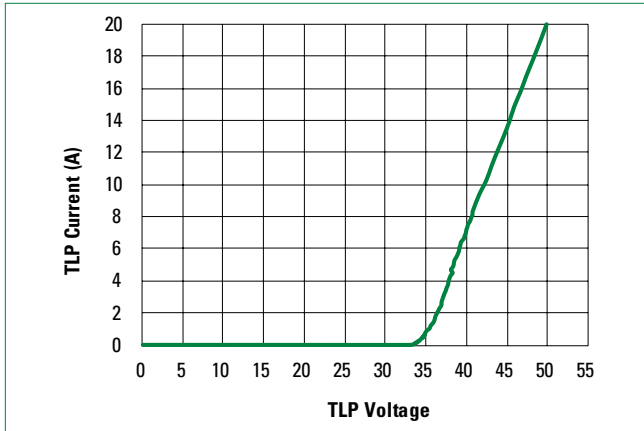

**Negative Transmission Line Pulsing (TLP) Plot**

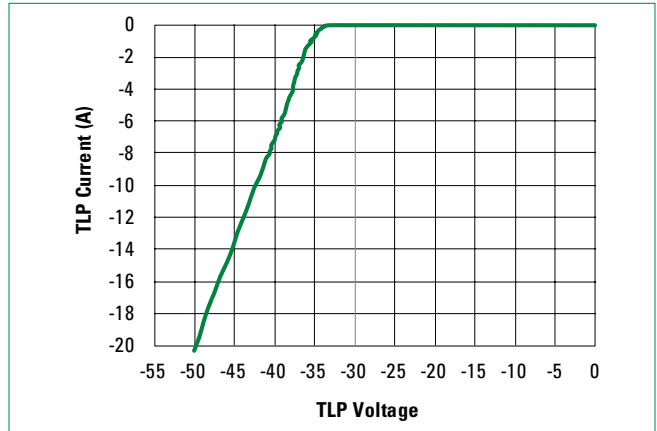

**IEC 61000-4-2 +8 kV Contact ESD Clamping Voltage**

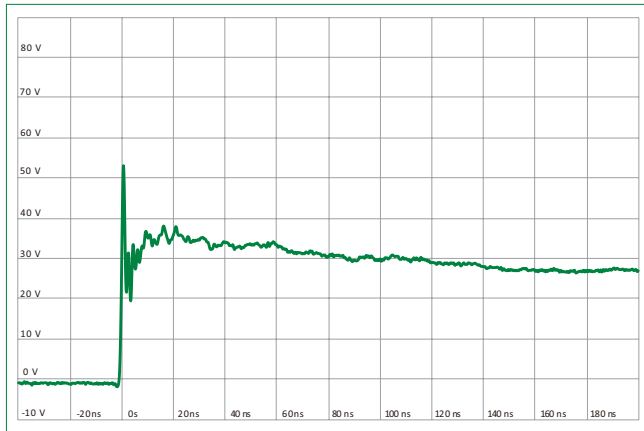

**IEC 61000-4-2 -8 kV Contact ESD Clamping Voltage**

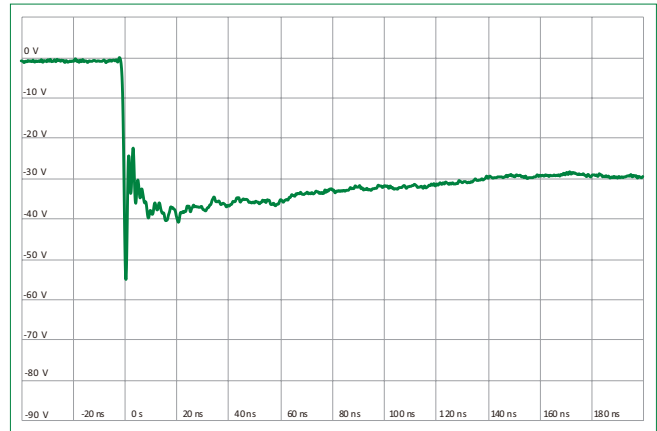

**ISO10605 Contact Discharge Plot at +8 kV**



**ISO10605 Contact Discharge Plot at -8 kV**

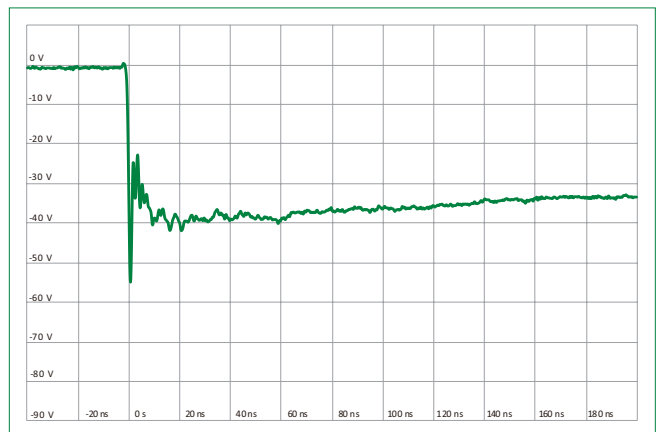

**AQ3130E-01ETG**

28V, 0.3pF, 30kV, SOD882, Bidirectional TVS, Ultra Low Capacitance ESD Protection

**Soldering Parameters**

<b>Reflow Condition</b>		Pb – Free assembly
<b>Pre Heat</b>	- Temperature Min ( $T_{s(min)}$ )	150°C
	- Temperature Max ( $T_{s(max)}$ )	200°C
	- Time (min to max) ( $t_s$ )	60 – 120 secs
<b>Average ramp up rate (Liquidus) Temp (<math>T_L</math>) to peak</b>		3°C/second max
<b><math>T_{s(max)}</math> to <math>T_L</math> - Ramp-up Rate</b>		3°C/second max
<b>Reflow</b>	- Temperature ( $T_L$ ) (Liquidus)	217°C
	- Temperature ( $t_L$ )	60 – 150 seconds
<b>Peak Temperature (<math>T_p</math>)</b>		260 <sup>+0/-5</sup> °C
<b>Time within 5°C of actual peak Temperature (<math>t_p</math>)</b>		30 seconds
<b>Ramp-down Rate</b>		6°C/second max
<b>Time 25°C to peak Temperature (<math>T_p</math>)</b>		8 minutes Max.
<b>Do not exceed</b>		260°C

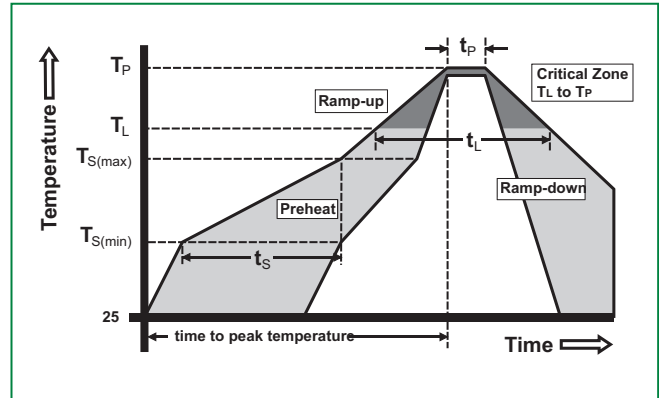
**Ordering Information**

Part Number	Package	Min. Order Qty.
AQ3130E-01ETG	SOD882	10,000

**Product Characteristics**

<b>Lead Plating</b>	Pre-Plated Frame
<b>Lead material</b>	Copper Alloy
<b>Body Material</b>	Molded Compound
<b>Flammability</b>	UL Recognized compound meeting flammability rating V-0

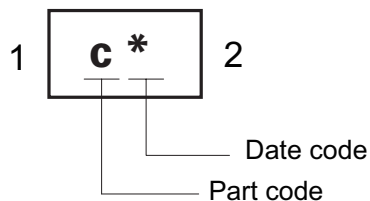
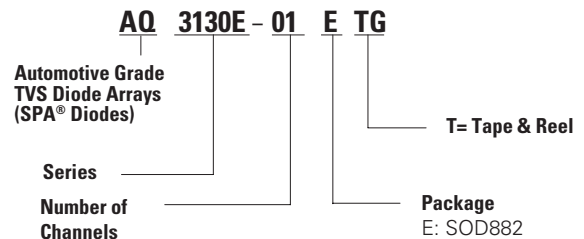
**Part Marking System****Part Numbering System**

**AQ3130E-01ETG**

28V, 0.3pF, 30kV, SOD882, Bidirectional TVS, Ultra Low Capacitance ESD Protection

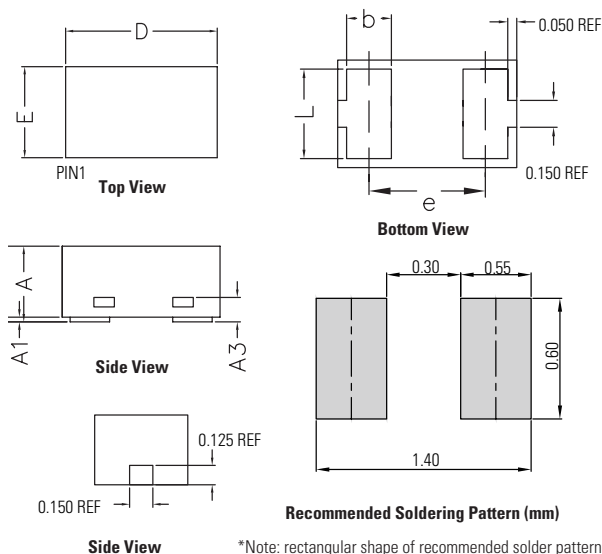
**Package Dimensions — SOD882**

\*Note: rectangular shape of recommended solder pattern can completely cover the whole  shape from the package's exposed pin.

Symbol	Millimeters	
	Min	Max
A	0.40	0.50
A1	0.00	0.05
A3	0.125 REF	
b	0.20	0.30
L	0.45	0.55
D	0.95	1.05
E	0.55	0.65
e	0.6 5BSC	

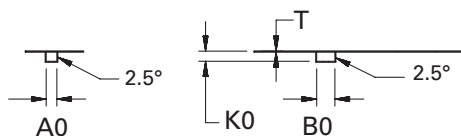
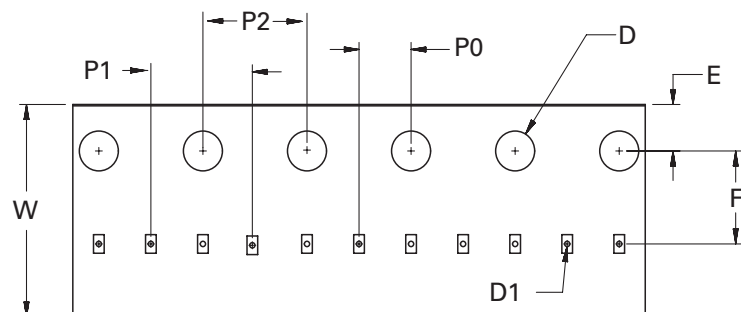
**Embossed Carrier Tape & Reel Specification — SOD882**

Component Orientation in Tape

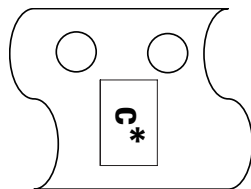

8mm Tape and Reel

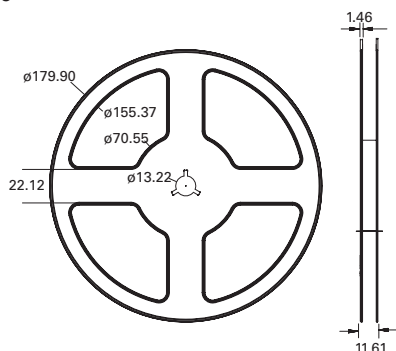

Symbol	Millimeters
A0	0.70+/-0.05
B0	1.15+/-0.05
D	1.50+0.10
D1	0.40+/-0.10
E	1.75+/-0.10
F	3.50+/-0.05
K0	0.55+/-0.05
P0	2.00+/-0.05
P1	4.00+/-0.10
P2	4.00+/-0.10
T	0.20+/-0.03
W	8.00+0.30/-0.10

**Product Disclaimer:** Littelfuse products are not designed for, and shall not be used for, any purpose (including, without limitation, automotive, military, aerospace, medical, life-saving, life-sustaining or nuclear facility applications, devices intended for surgical implant into the body, or any other application in which the failure or lack of desired operation of the product may result in personal injury, death, or property damage) other than those expressly set forth in applicable Littelfuse product documentation. Warranties granted by Littelfuse shall be deemed void for products used for any purpose not expressly set forth in applicable Littelfuse documentation. Littelfuse shall not be liable for any claims or damages arising out of products used in applications not expressly intended by Littelfuse as set forth in applicable Littelfuse documentation. The sale and use of Littelfuse products is subject to Littelfuse Terms and Conditions of Sale, unless otherwise agreed by Littelfuse. "Littelfuse" includes Littelfuse, Inc., and all of its affiliate entities. <http://www.littelfuse.com/disclaimer-electronics>.