

AQ3052-02RTG

5 V, 10 A, SOT523-3L, 2 Channel-Unidirectional TVS, Lightning Surge Protection



Note: This package image is for example and reference only. For detail package drawing, please refer to the package section in this datasheet.

Pinout

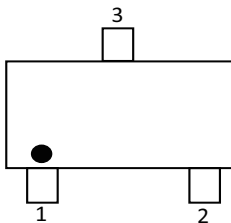

Functional Block Diagram

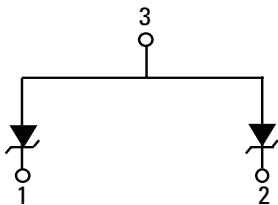

Description

The AQ3052-02RTG is a low-capacitance, TVS Diode Array designed to provide 2 channel protections against ESD (electrostatic discharge) and lightning induced surges.

This robust device can safely absorb repetitive ESD strikes at the maximum level specified in the IEC 61000-4-2 international standard (Level 4, ± 8 kV contact discharge) without performance degradation and safely dissipate 10 A of 8/20 μ s surge current (IEC61000-4-5 2nd edition).

Features

- ESD, IEC 61000-4-2, ± 30 kV contact/air
- ESD, ISO10605 330 pF 330 Ω , ± 30 kV contact/air
- EFT, IEC 61000-4-4, 40 A (5/50 ns)
- Maximum surge tolerance, IEC 61000-4-5 2nd edition, 10 A (8/20 μ s)
- Low capacitance of 1 pF@1 MHz (typ @ $V_R = 0$ V)
- Low clamping voltage
- Halogen-free, lead-free and RoHS compliant
- Moisture sensitivity level (MSL-1)
- AEC-Q101 qualified and PPAP capable

Applications

- Automotive
- USB2.0
- Display port
- 10/100/1000 ethernet
- LVDS line video lines

Life Support Note:

Not Intended for Use in Life Support or Life Saving Applications

The products shown herein are not designed for use in life sustaining or life saving applications unless otherwise expressly indicated.

AQ3052-02RTG

5 V, 10 A, SOT523-3L, 2 Channel-Unidirectional TVS, Lightning Surge Protection

Absolute Maximum Ratings

Symbol	Parameter	Value	Units
I_{PP}	Peak Current ($t_p = 8/20 \mu s$)	10	A
T_{OP}	Operating Temperature	-40 to 150	°C
T_{STOR}	Storage Temperature	-55 to 150	°C

CAUTION: Stresses above those listed in "Absolute Maximum Ratings" may cause permanent damage to the component. This is a stress only rating and operation of the component at these or any other conditions above those indicated in the operational sections of this specification is not implied.

Electrical Characteristics ($T_{OP} = 25 \text{ }^\circ\text{C}$)

Parameter	Symbol	Test Conditions	Min	Typ	Max	Units
Reverse Standoff Voltage	V_{RWM}				5	V
Breakdown Voltage	V_{BR}	$I_R = 1 \text{ mA}$	6.0	8.5	11.0	V
Reverse Leakage Current	I_{LEAK}	$V_R = 5 \text{ V}$		5	50	nA
Clamp Voltage ¹	V_C	$I_{PP} = 5 \text{ A}$, $t_p = 8/20 \mu s$, Pin1/2 to Pin3		12		V
		$I_{PP} = 10 \text{ A}$, $t_p = 8/20 \mu s$, Pin1/2 to Pin3		14		V
		ESD = 8 kV, $t_p = 0.2/100 \text{ ns}$, Pin1/2 to Pin3		14		V
Dynamic Resistance ^{1,2}	R_{DYN}	TLP, $t_p = 100 \text{ ns}$, Pin1/2 to Pin3		0.2		Ω
ESD Withstand Voltage ^{1,3,4}	V_{ESD}	IEC 61000-4-2 (Contact Discharge)	± 30			kV
		IEC 61000-4-2 (Air Discharge)	± 30			kV
		ISO10605 (Contact Discharge)	± 30			kV
		ISO10605 (Air Discharge)	± 30			kV
Diode Capacitance ¹	C_{IO-GND}	Reverse Bias = 0 V, $f = 1 \text{ MHz}$, Pin1/2 to Pin3			1.0	pF
	C_{IO-IO}	Reverse Bias = 0 V, $f = 1 \text{ MHz}$, Pin1 to Pin2		0.5	0.8	pF

Note:

- Parameter is guaranteed by design and/or component characterization.
- Transmission Line Pulse (TLP) with 100 ns width, 0.2 ns rise time, and average window $t_1 = 70 \text{ ns}$ to $t_2 = 90 \text{ ns}$.
- Device stressed with ten non-repetitive ESD pulses according to IEC61000-4-2 ($R = 330 \Omega$, $C = 150 \text{ pF}$).
- Device stressed with three non-repetitive ESD pulses according to ISO10605 ($R = 330 \Omega$, $C = 330 \text{ pF}$).

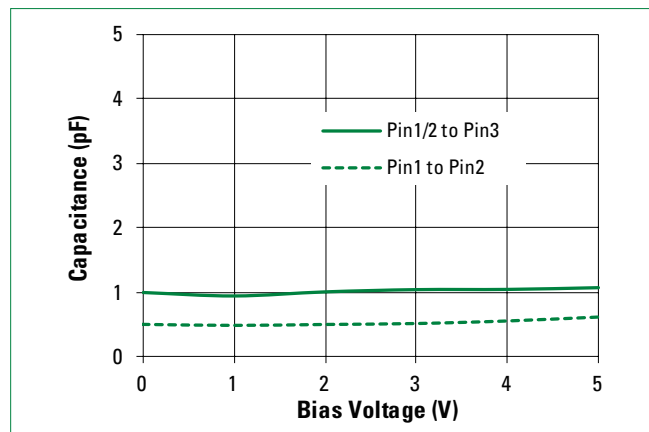
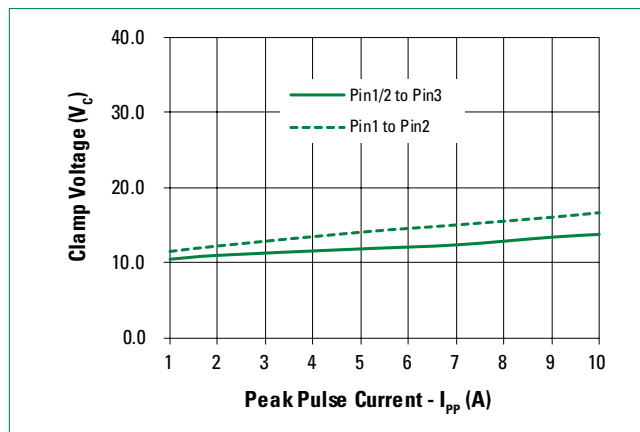
Capacitance vs. Reverse Bias**Clamping Voltage vs I_{PP}** 

AQ3052-02RTG

5 V, 10 A, SOT523-3L, 2 Channel-Unidirectional TVS, Lightning Surge Protection

Positive Transmission Line Pulsing (TLP) Plot

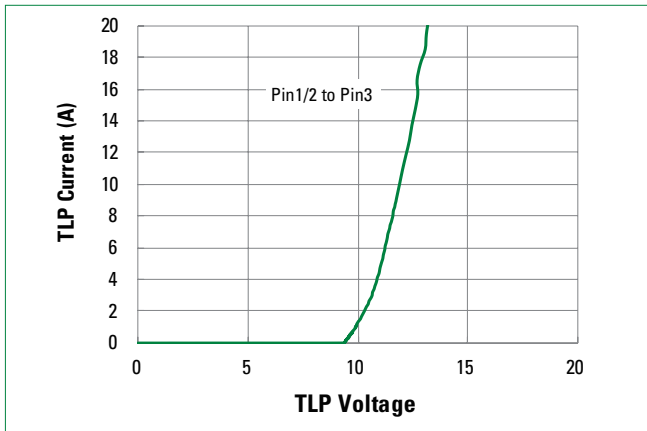

Negative Transmission Line Pulsing (TLP) Plot

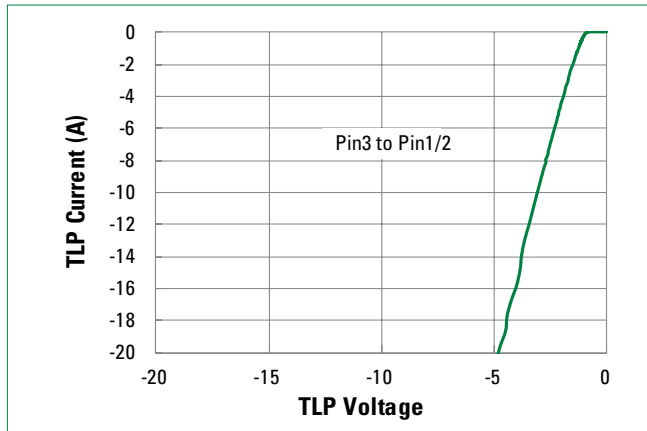

IEC 61000-4-2 +8 kV Contact ESD Clamping Voltage



IEC 61000-4-2 -8 kV Contact ESD Clamping Voltage

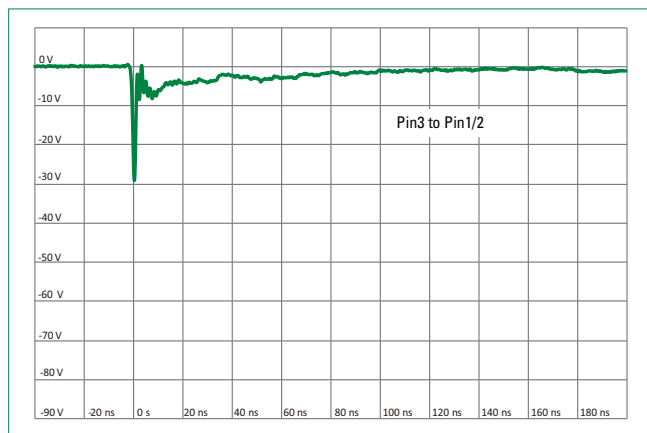

ISO10605 Contact Discharge Plot at +8 kV

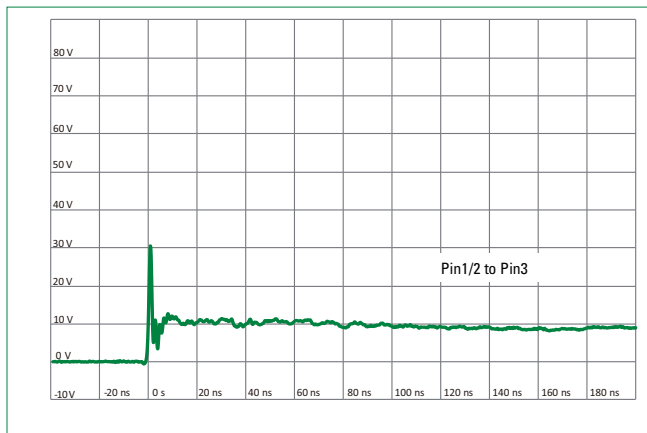

ISO10605 Contact Discharge Plot at -8 kV

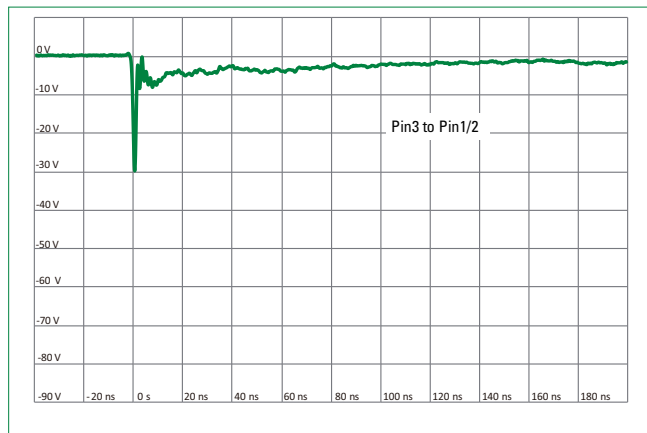

AQ3052-02RTG

5 V, 10 A, SOT523-3L, 2 Channel-Unidirectional TVS, Lightning Surge Protection

Soldering Parameters

Reflow Condition		Pb – Free assembly
Pre Heat	- Temperature Min ($T_{s(min)}$)	150 °C
	- Temperature Max ($T_{s(max)}$)	200 °C
	- Time (min to max) (t_s)	60 – 120 seconds
Average Ramp Up Rate (Liquidus) Temp (T_L) to Peak		3 °C/second max
$T_{s(max)}$ to T_L - Ramp-up Rate		3 °C/second max
Reflow	- Temperature (T_L) (Liquidus)	217 °C
	- Temperature (t_l)	60 – 150 seconds
Peak Temperature (T_p)		260 ^{+0/-5} °C
Time Within 5 °C of Actual Peak Temperature (t_p)		30 seconds
Ramp-down Rate		6 °C/second max
Time 25 °C to Peak Temperature (T_p)		8 minutes max
Do Not Exceed		260 °C

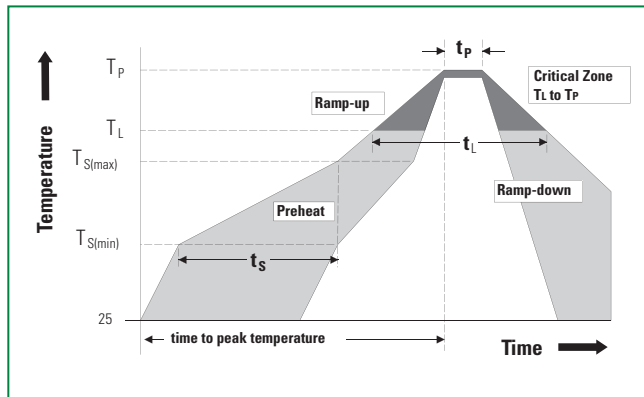
**Ordering Information**

Part Number	Package	Min. Order Qty
AQ3052-02RTG	SOT523-3L	3000

Product Characteristics

Lead Plating	Matte tin
Lead Material	Copper alloy
Substrate Material	Silicon
Body Material	Molded compound
Flammability	UL recognized compound meeting flammability rating V-0

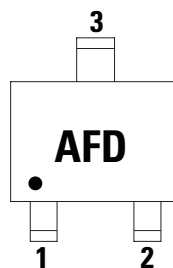
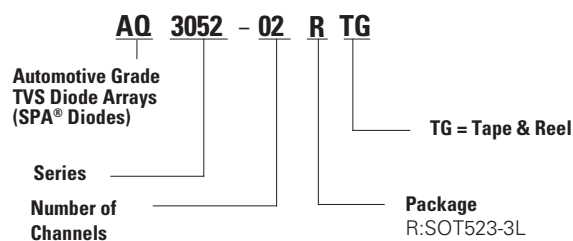
Part Marking System**Part Numbering System**

AQ3052-02RTG

5 V, 10 A, SOT523-3L, 2 Channel-Unidirectional TVS, Lightning Surge Protection

Package Dimensions — SOT523-3L

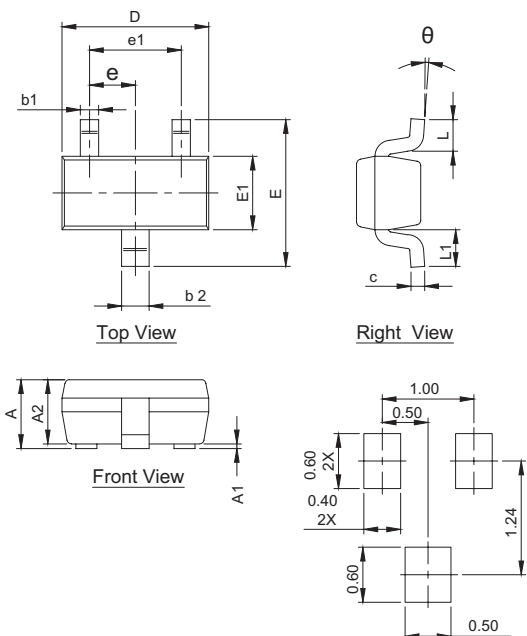

Symbol	Millimeters		Inches	
	Min	Max	Min	Max
A	0.700	0.900	0.0276	0.0354
A1	0.000	0.100	0.0000	0.0039
A2	0.700	0.800	0.0276	0.0315
b1	0.150	0.250	0.0059	0.0098
b2	0.250	0.350	0.0098	0.0138
c	0.100	0.200	0.0039	0.0079
D	1.500	1.700	0.0591	0.0669
E	1.450	1.750	0.0571	0.0689
E1	0.700	0.900	0.0276	0.0354
e	0.500 TYP.		0.0197 TYP.	
e1	0.900	1.100	0.0354	0.0433
L	0.260	0.460	0.0102	0.0181
L1	0.400 REF.		0.0157 REF.	
theta	0°	8°	0°	8°

Recommended Soldering Pattern (unit :mm)

Embossed Carrier Tape & Reel Specification — SOT523-3L

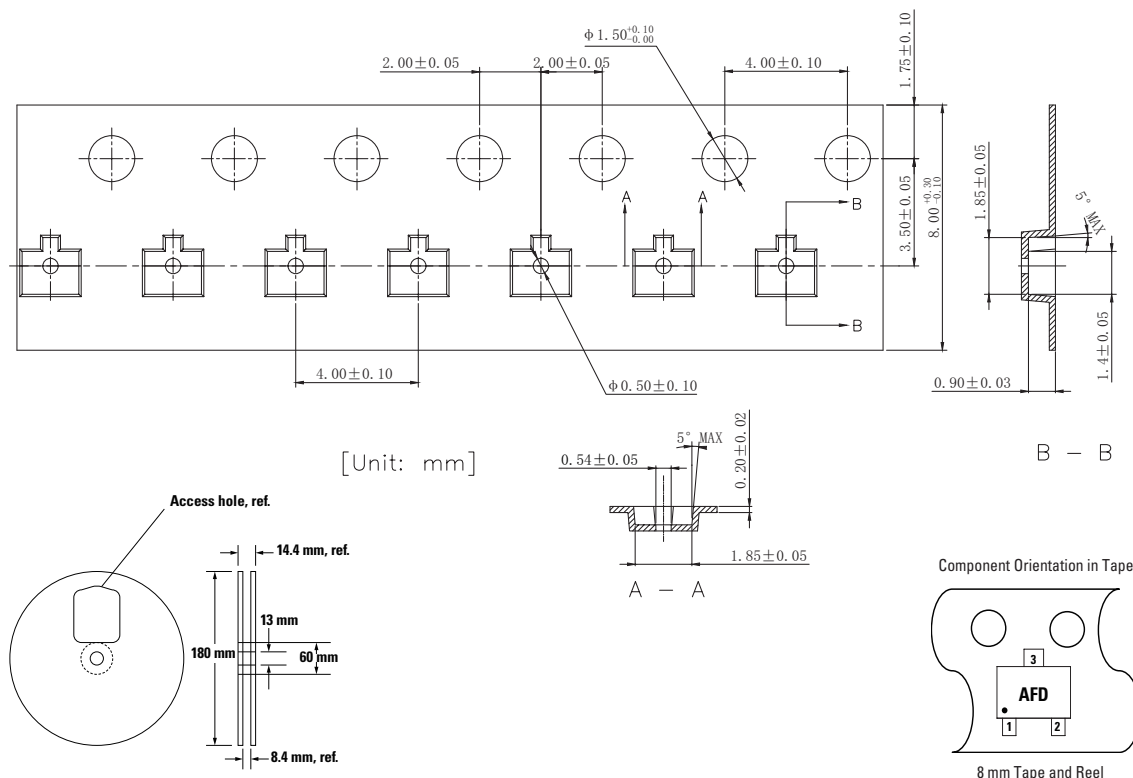

Disclaimer Notice - Information furnished is believed to be accurate and reliable. However, users should independently evaluate the suitability of and test each product selected for their own applications. Littelfuse products are not designed for, and may not be used in, all applications. Read complete Disclaimer Notice at <http://www.littelfuse.com/disclaimer-electronics>.