

# AQ27COM-02JTG

## 27 V Bidirectional 200 W TVS Diode Array, General Purpose ESD Protection



### Description

The AQ27COM-02JTG bidirectional TVS is fabricated in a proprietary silicon avalanche technology. These diodes provide a high ESD (electrostatic discharge) protection level for electronic equipment.

The AQ27COM-02JTG TVS can safely absorb repetitive ESD strikes of  $\pm 30$  kV (contact and air discharge as defined in IEC 61000-4-2) without any performance degradation. In addition, it can safely dissipate a 4 A 8/20  $\mu$ s surge event as defined in IEC 61000-4-5, 2<sup>nd</sup> edition.

### Pinout

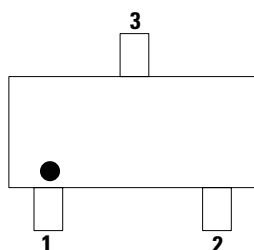

### Functional Block Diagram

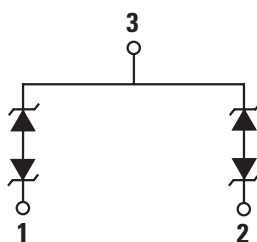

### Features

- ESD, IEC 61000-4-2,  $\pm 30$  kV contact/air
- ESD, ISO 10605, 330 pF 330  $\Omega$ ,  $\pm 30$  kV contact/air
- EFT, IEC 61000-4-4, 40 A (5/50 ns)
- Maximum surge tolerance, IEC 61000-4-5 2<sup>nd</sup> edition, 4 A (8/20  $\mu$ s)
- Halogen free, lead free and RoHS compliant
- Moisture sensitivity level (MSL-1)
- AEC-Q101 qualified and PPAP capable

### Applications

- Automotive
- ADAS Control Units
- Body Control Units
- CAN Bus
- Electronic Control Units
- Factory Automation
- Lighting Control (DALI)
- PowerTrain Control Units
- Sensor Protection

#### Life Support Note:

Not Intended for Use in Life Support or Life Saving Applications

The products shown herein are not designed for use in life sustaining or life saving applications unless otherwise expressly indicated.

# AQ27COM-02JTG

## 27 V Bidirectional 200 W TVS Diode Array, General Purpose ESD Protection

### Absolute Maximum Ratings

Symbol	Parameter	Value	Units
$P_{PK}$	Peak Pulse Power ( $t_p = 8/20 \mu s$ )	200	W
$I_{PP}$	Peak Current ( $t_p = 8/20 \mu s$ )	4	A
$T_{OP}$	Operating Temperature	-40 to 150	°C
$T_{STOR}$	Storage Temperature	-55 to 150	°C

**CAUTION:** Stresses above those listed in "Absolute Maximum Ratings" may cause permanent damage to the component. This is a stress only rating and operation of the component at these or any other conditions above those indicated in the operational sections of this specification is not implied.

### Electrical Characteristics ( $T_{OP} = 25 \text{ }^\circ\text{C}$ )

Parameter	Symbol	Test Conditions	Min	Typ	Max	Units
Reverse Standoff Voltage	$V_{RWM}$	Pin 1 or Pin2 to Pin 3			27	V
Breakdown Voltage	$V_{BR}$	$I_R = 1 \text{ mA}$ , Pin 1 or Pin2 to Pin 3	28		35	V
Reverse Leakage Current	$I_{LEAK}$	$V_R = 27 \text{ V}$		10	50	nA
Clamp Voltage <sup>1</sup>	$V_C$	$I_{PP} = 1 \text{ A}$ , $t_p = 8/20 \mu s$ , Pin 1 or Pin2 to Pin 3		40.5		V
		$I_{PP} = 4 \text{ A}$ , $t_p = 8/20 \mu s$ , Pin 1 or Pin2 to Pin 3		50		V
Dynamic Resistance <sup>2</sup>	$R_{DYN}$	TLP, $t_p = 100 \text{ ns}$ , Pin 1 or Pin2 to Pin 3		0.5		$\Omega$
ESD Withstand Voltage <sup>1</sup>	$V_{ESD}$	IEC 61000-4-2 (Contact Discharge)	$\pm 30$			kV
		IEC 61000-4-2 (Air Discharge)	$\pm 30$			kV
		ISO 10605 (Contact Discharge)	$\pm 30$			kV
		ISO 10605 (Air Discharge)	$\pm 30$			kV
Diode Capacitance <sup>1</sup>	$C_{I/O-GND}$	Reverse Bias = 0 V, $f = 1 \text{ MHz}$ ; Pin 1 or Pin 2 to Pin 3		12		pF

**Note:**

- Parameter is guaranteed by design and/or component characterization.
- Transmission Line Pulse (TLP) with 100ns width, 0.2 ns rise time, and average window  $t_1 = 70 \text{ ns}$  to  $t_2 = 90 \text{ ns}$ .
- Device stressed with ten non-repetitive ESD pulses.

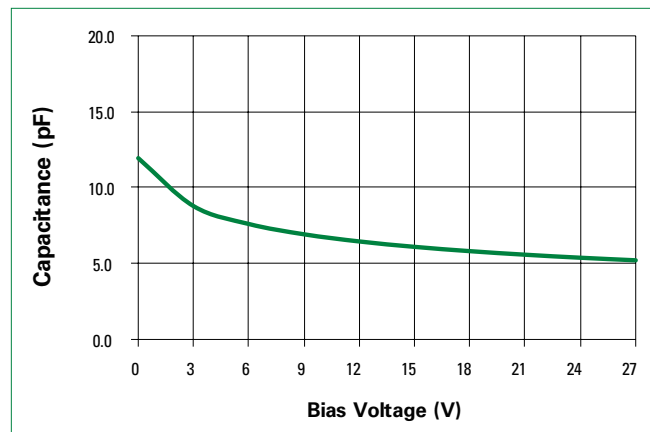
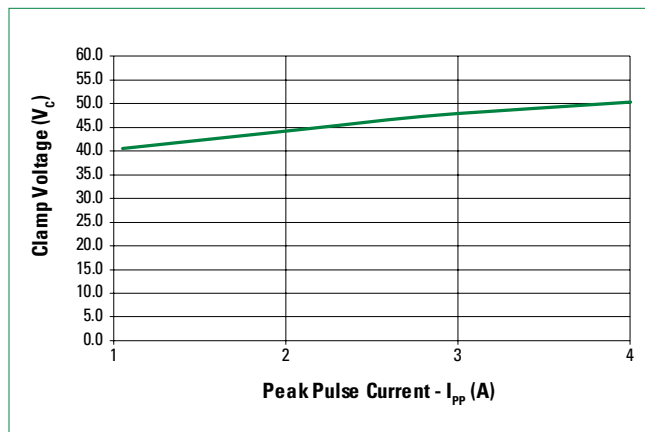
**Capacitance vs. Reverse Bias****Clamping Voltage vs  $I_{PP}$** 

# AQ27COM-02JTG

27 V Bidirectional 200 W TVS Diode Array, General Purpose ESD Protection

Positive Transmission Line Pulsing (TLP) Plot

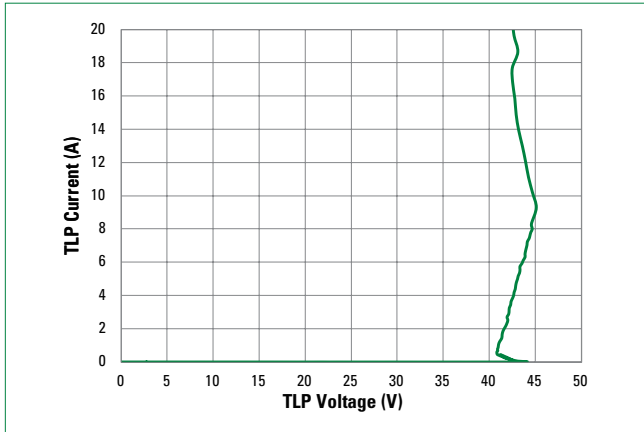

Negative Transmission Line Pulsing (TLP) Plot

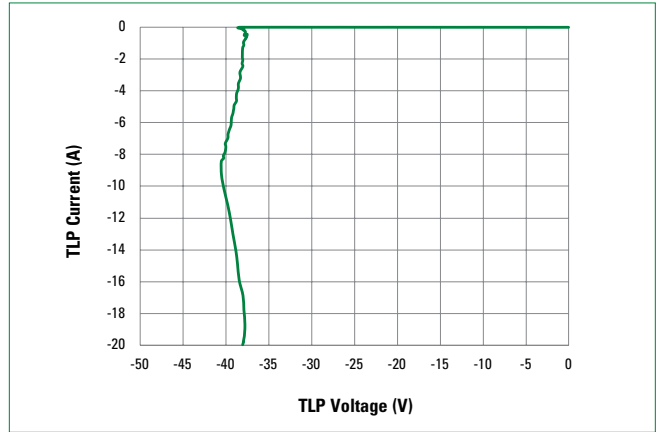

IEC 61000-4-2 +8 kV Contact ESD Clamping Voltage

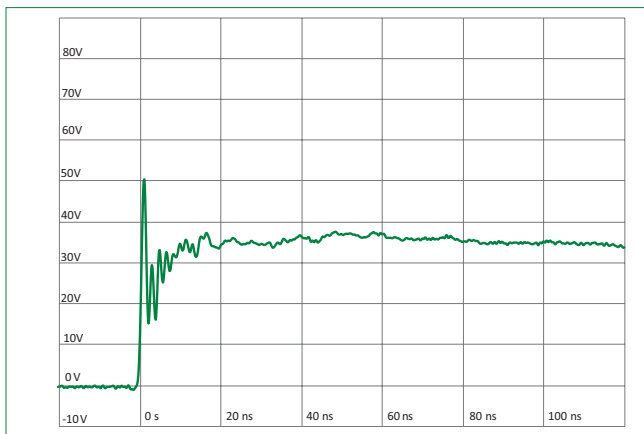

IEC 61000-4-2 -8 kV Contact ESD Clamping Voltage

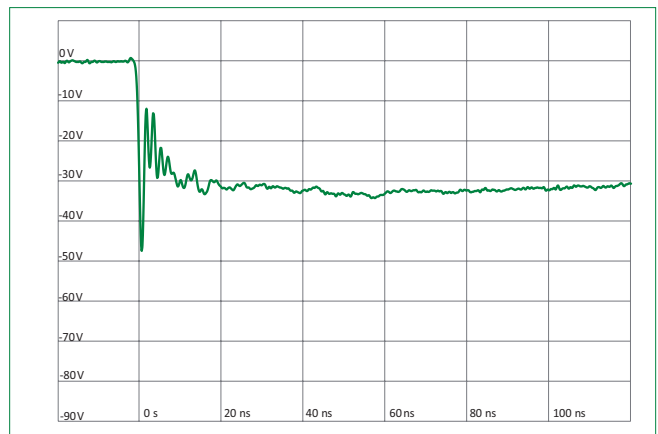

ISO10605 Contact Discharge Plot at +8 kV

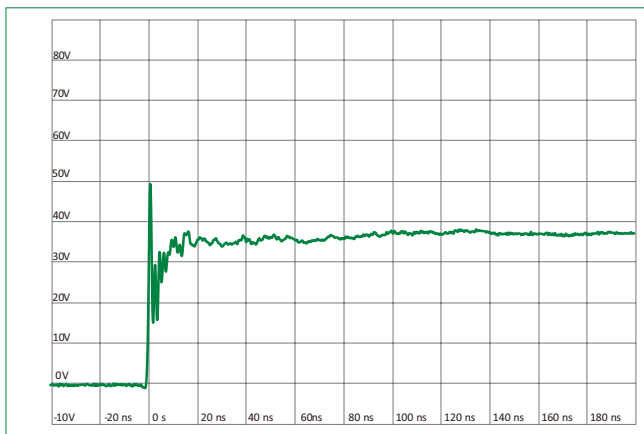

ISO10605 Contact Discharge Plot at -8 kV



# AQ27COM-02JTG

## 27 V Bidirectional 200 W TVS Diode Array, General Purpose ESD Protection

### Soldering Parameters

<b>Reflow condition</b>		Pb – Free assembly
<b>Pre Heat</b>	- Temperature min ( $T_{s(min)}$ )	150 °C
	- Temperature max ( $T_{s(max)}$ )	200 °C
	- Time (min to max) ( $t_s$ )	60 – 120 secs
<b>Average ramp up rate (Liquidus) temp (<math>T_L</math>) to peak</b>		3 °C/second max
<b><math>T_{s(max)}</math> to <math>T_L</math> - Ramp-up rate</b>		3 °C/second max
<b>Reflow</b>	- Temperature ( $T_L$ ) (Liquidus)	217 °C
	- Temperature ( $t_L$ )	60 – 150 seconds
<b>Peak temperature (<math>T_p</math>)</b>		260 <sup>+0/-5</sup> °C
<b>Time within 5 °C of actual peak temperature (<math>t_p</math>)</b>		30 seconds
<b>Ramp-down rate</b>		6 °C/second max
<b>Time 25 °C to peak temperature (<math>T_p</math>)</b>		8 minutes max
<b>Do not exceed</b>		260 °C

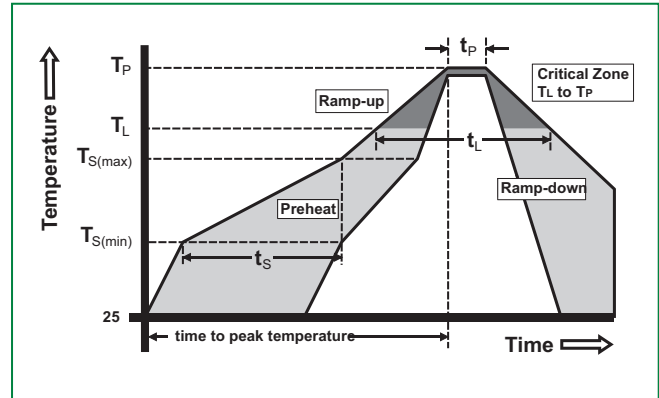

### Product Characteristics

<b>Lead plating</b>	Matte tin
<b>Lead material</b>	Copper alloy
<b>Body material</b>	Molded compound
<b>Flammability</b>	UL recognized compound meeting flammability rating V-0

### Ordering Information

Part Number	Package	Min. Order Qty.
AQ27COM-02JTG	SC70-3	3000

### Part Marking System

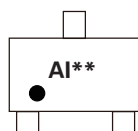

AI = Part code  
 \* = Assembly code  
 \* = Date code

### Part Numbering System

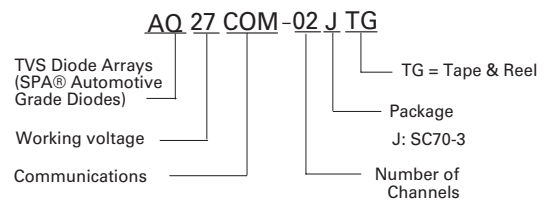

**AQ27COM-02JTG**

27 V Bidirectional 200 W TVS Diode Array, General Purpose ESD Protection

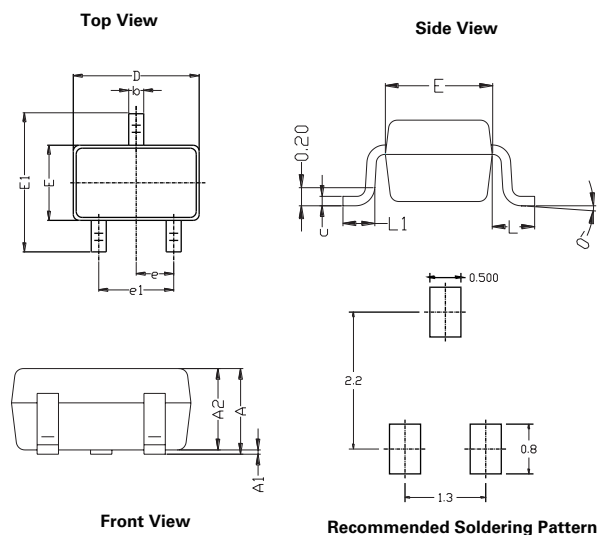
**Package Dimensions**

Symbol	Millimeters		Inches	
	Min	Max	Min	Max
A	0.90	1.10	0.035	0.043
A1	0.00	0.10	0.000	0.004
A2	0.90	1.00	0.035	0.039
b	0.20	0.40	0.008	0.016
C	0.08	0.15	0.003	0.006
D	2.00	2.20	0.079	0.087
E	1.15	1.35	0.045	0.053
E1	2.15	2.40	0.085	0.094
e	0.650 Typ		0.026 Typ	
e1	1.20	1.40	0.047	0.055
L	0.53 Ref		0.021 Ref	
L1	0.26	0.45	0.010	0.018
θ	0°	8°	0°	8°

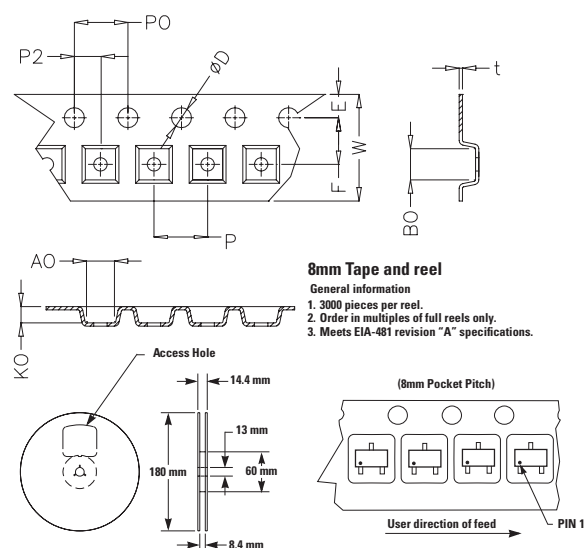
**Embossed Carrier Tape & Reel Specification**

Symbol	Millimeters		Inches	
	Min	Max	Min	Max
E	1.65	1.85	0.065	0.073
F	3.4	3.6	0.134	0.142
P2	1.9	2.1	0.075	0.083
D	1.4	1.6	0.055	0.063
P0	3.9	4.1	0.154	0.161
W	7.7	8.3	0.303	0.327
P	3.9	4.1	0.154	0.161
A0	3.05	3.25	0.12	0.128
B0	2.67	2.87	0.105	0.113
K0	1.12	1.32	0.044	0.052
t	0.22	0.24	0.009	0.009

**Product Disclaimer:** Littelfuse products are not designed for, and shall not be used for, any purpose (including, without limitation, automotive, military, aerospace, medical, life-saving, life-sustaining or nuclear facility applications, devices intended for surgical implant into the body, or any other application in which the failure or lack of desired operation of the product may result in personal injury, death, or property damage) other than those expressly set forth in applicable Littelfuse product documentation. Warranties granted by Littelfuse shall be deemed void for products used for any purpose not expressly set forth in applicable Littelfuse documentation. Littelfuse shall not be liable for any claims or damages arising out of products used in applications not expressly intended by Littelfuse as set forth in applicable Littelfuse documentation. The sale and use of Littelfuse products is subject to Littelfuse Terms and Conditions of Sale, unless otherwise agreed by Littelfuse. "Littelfuse" includes Littelfuse, Inc., and all of its affiliate entities. <http://www.littelfuse.com/disclaimer-electronics>.