

**AQ22-01FTG, 950W Discrete Unidirectional TVS Diode**



**Description**

The Unidirectional AQ22-01FTG is designed for use in electronic equipment for low speed and DC applications. It will protect any sensitive equipment from damage due to electrostatic discharge (ESD) and other transient events. The AQ22 series can safely absorb repetitive ESD strikes at  $\pm 30\text{kV}$  (contact discharge, IEC 61000-4-2) without performance degradation and safely dissipate 27A of 8/20 $\mu\text{s}$  induced surge current (IEC 61000-4-5 2nd edition) with very low clamping voltages.

**Pinout and Functional Block Diagram**

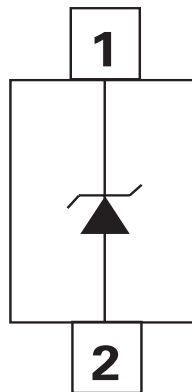

**Features**

- ESD, IEC 61000-4-2,  $\pm 30\text{kV}$  contact,  $\pm 30\text{kV}$  air
- EFT, IEC 61000-4-4, 40A (5/50ns)
- Lightning, IEC 61000-4-5 2<sup>nd</sup> edition, 27A ( $t_p=8/20\mu\text{s}$ )
- Low clamping voltage
- Low leakage current
- Small SOD323 package fits 0805 footprints
- AEC-Q101 qualified
- Moisture Sensitivity Level(MSL -1)
- Halogen-free, lead-free and RoHS-compliant

**Applications**

- Switches / Buttons
- Test Equipment / Instrumentation
- Point-of-Sale Terminals
- Medical Equipment
- Notebooks / Desktops / Servers
- Computer Peripherals
- Automotive applications

Life Support Note:

**Not Intended for Use in Life Support or Life Saving Applications**

The products shown herein are not designed for use in life sustaining or life saving applications unless otherwise expressly indicated.

### Absolute Maximum Ratings

| Symbol     | Parameter                            | Value      | Units |
|------------|--------------------------------------|------------|-------|
| $P_{pk}$   | Peak Pulse Power ( $t_p=8/20\mu s$ ) | 950        | W     |
| $T_{OP}$   | Operating Temperature                | -40 to 150 | °C    |
| $T_{STOR}$ | Storage Temperature                  | -55 to 150 | °C    |

Notes:

**CAUTION:** Stresses above those listed in "Absolute Maximum Ratings" may cause permanent damage to the component. This is a stress only rating and operation of the component at these or any other conditions above those indicated in the operational sections of this specification is not implied.

### Electrical Characteristics ( $T_{OP}=25^\circ C$ )

| Parameter                          | Symbol        | Test Conditions                   | Min      | Typ  | Max  | Units    |
|------------------------------------|---------------|-----------------------------------|----------|------|------|----------|
| Reverse Standoff Voltage           | $V_{RWM}$     | $I_R=1\mu A$                      |          |      | 22.0 | V        |
| Breakdown Voltage                  | $V_{BR}$      | $I_R=1mA$                         | 23       |      |      | V        |
| Reverse Leakage Current            | $I_{LEAK}$    | $V_R=22V$                         |          | 0.02 | 0.5  | $\mu A$  |
| Clamp Voltage <sup>1</sup>         | $V_C$         | $I_{pp}=27A, t_p=8/20\mu s, Fwd$  |          | 35.5 |      | V        |
| Dynamic Resistance <sup>2</sup>    | $R_{DYN}$     | TLP, $t_p=100ns, I/O$ to Ground   |          | 0.13 |      | $\Omega$ |
| Peak Pulse Current                 | $I_{pp}$      | $t_p=8/20\mu s$                   |          |      | 27   | A        |
| ESD Withstand Voltage <sup>1</sup> | $V_{ESD}$     | IEC 61000-4-2 (Contact Discharge) | $\pm 30$ |      |      | kV       |
|                                    |               | IEC 61000-4-2 (Air Discharge)     | $\pm 30$ |      |      | kV       |
| Diode Capacitance <sup>1</sup>     | $C_{I/O-GND}$ | Reverse Bias=0V, $f=1MHz$         |          | 160  |      | pF       |

Note:

- Parameter is guaranteed by design and/or component characterization.
- Transmission Line Pulse (TLP) with 100ns width, 2ns rise time, and average window  $t_1=70ns$  to  $t_2=90ns$

### Power Derating Curve

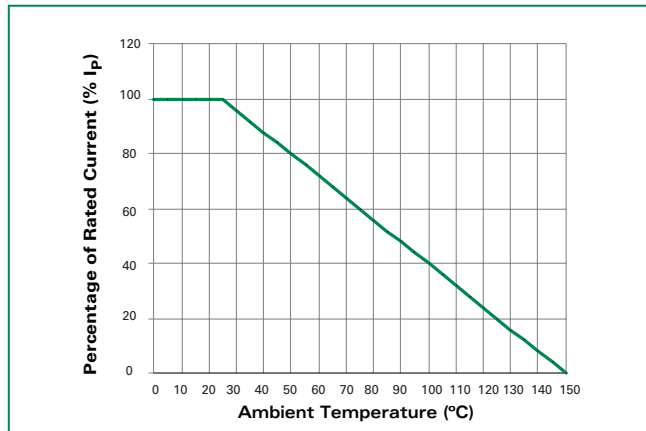

### 8/20 $\mu s$ Pulse Waveform

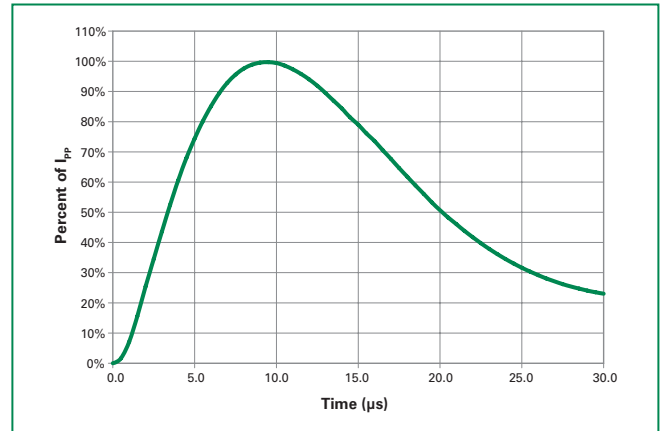

**Capacitance vs Reverse Bias**

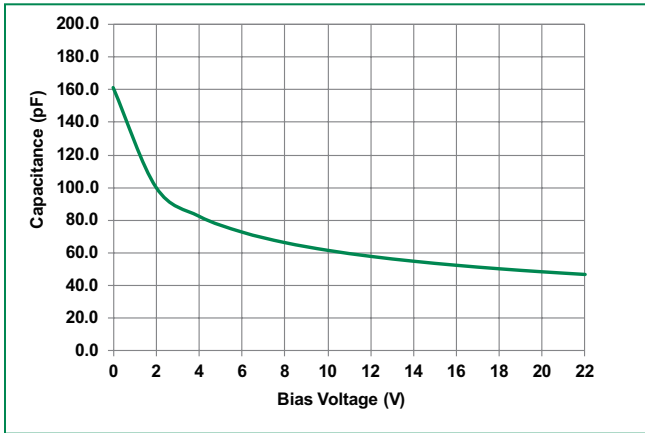

**Clamping Voltage vs  $I_{pp}$**

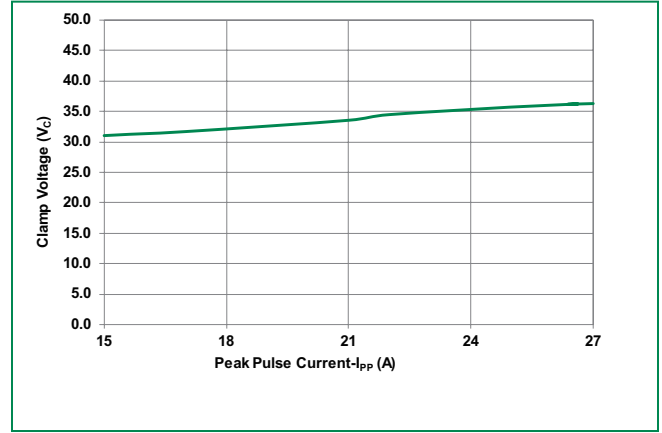

**Negative Transmission Line Pulsing (TLP) Plot**

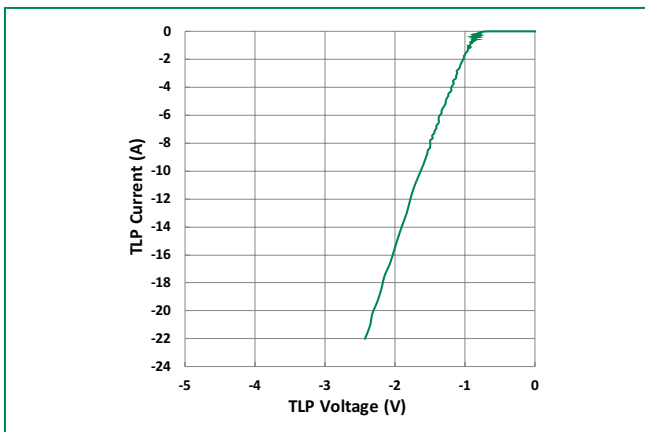

**Positive Transmission Line Pulsing (TLP) Plot**

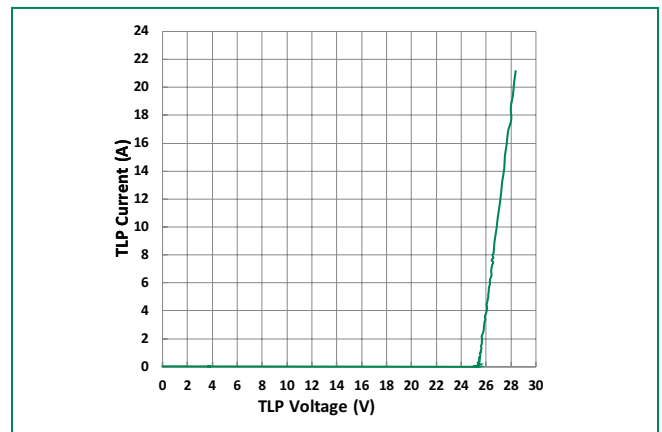

**Non-Repetitive Peak Pulse Power vs. Pulse Time**



**IEC 61000-4-2 +8 kV Contact ESD Clamping Voltage**

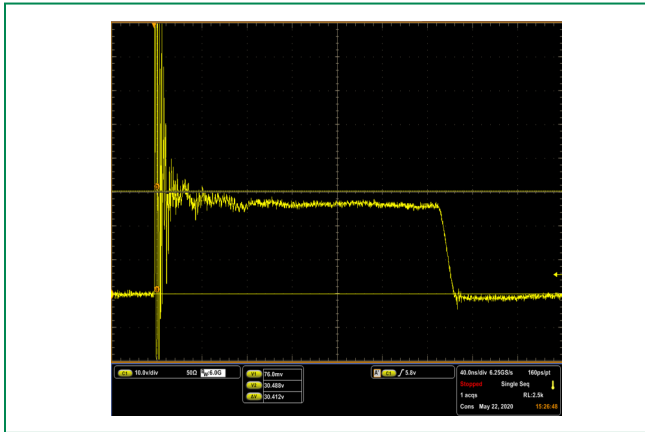

**IEC 61000-4-2 -8 kV Contact ESD Clamping Voltage**

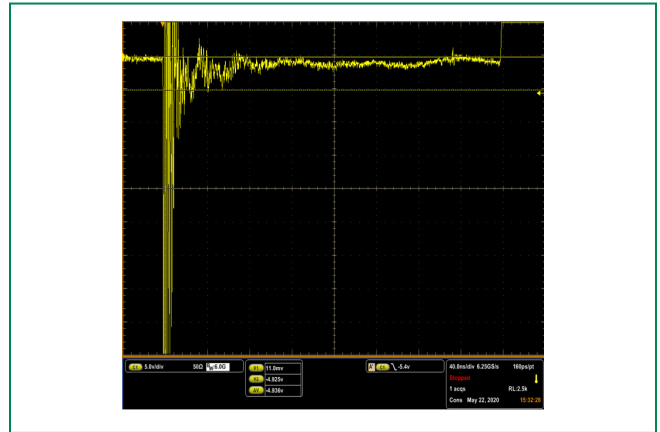

**ISO10605 (C:330pF, R:330Ω) contact discharge plot at +8 kV**

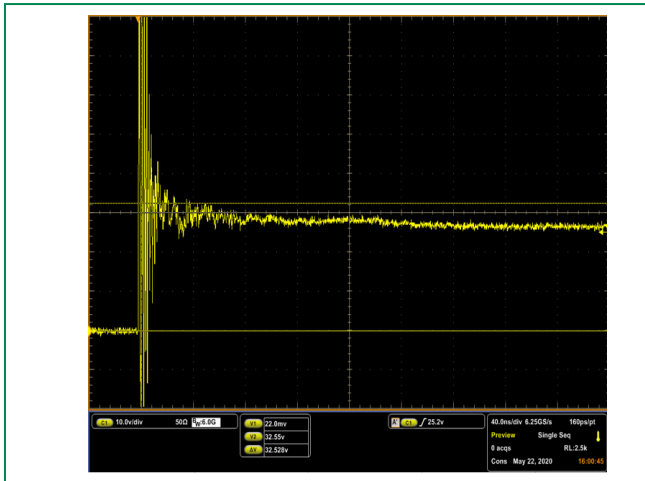

**ISO10605 (C:330pF, R:330Ω) contact discharge plot at -8 kV**

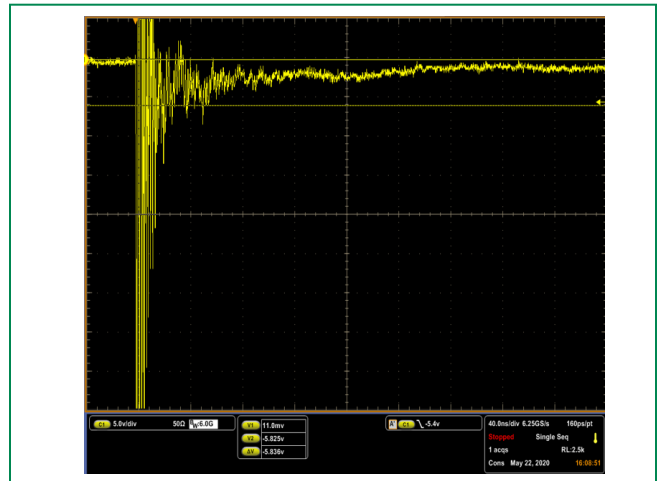

**Soldering Parameters**

|                                                        |                                    |                         |
|--------------------------------------------------------|------------------------------------|-------------------------|
| Reflow Condition                                       |                                    | Pb – Free assembly      |
| Pre Heat                                               | - Temperature Min ( $T_{s(min)}$ ) | 150°C                   |
|                                                        | - Temperature Max ( $T_{s(max)}$ ) | 200°C                   |
|                                                        | - Time (min to max) ( $t_s$ )      | 60 – 180 secs           |
| Average ramp up rate (Liquidus) Temp ( $T_L$ ) to peak |                                    | 3°C/second max          |
| $T_{s(max)}$ to $T_L$ - Ramp-up Rate                   |                                    | 3°C/second max          |
| Reflow                                                 | - Temperature ( $T_L$ ) (Liquidus) | 217°C                   |
|                                                        | - Temperature ( $t_L$ )            | 60 – 150 seconds        |
| Peak Temperature ( $T_p$ )                             |                                    | 260 <sup>+0/-5</sup> °C |
| Time within 5°C of actual peak Temperature ( $t_p$ )   |                                    | 20 – 40 seconds         |
| Ramp-down Rate                                         |                                    | 6°C/second max          |
| Time 25°C to peak Temperature ( $T_p$ )                |                                    | 8 minutes Max.          |
| Do not exceed                                          |                                    | 260°C                   |

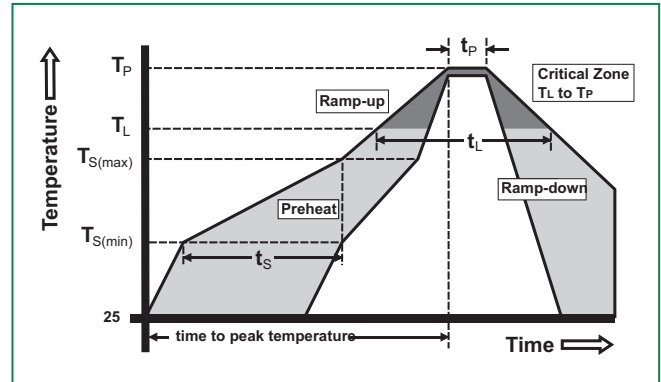

**Product Characteristics**

|                           |                                                        |
|---------------------------|--------------------------------------------------------|
| <b>Lead Plating</b>       | Matte Tin                                              |
| <b>Lead Material</b>      | Copper Alloy                                           |
| <b>Lead Coplanarity</b>   | 0.0004 inches (0.102mm)                                |
| <b>Substrate Material</b> | Silicon                                                |
| <b>Body Material</b>      | Molded Compound                                        |
| <b>Flammability</b>       | UL Recognized compound meeting flammability rating V-0 |

**Part Numbering System**

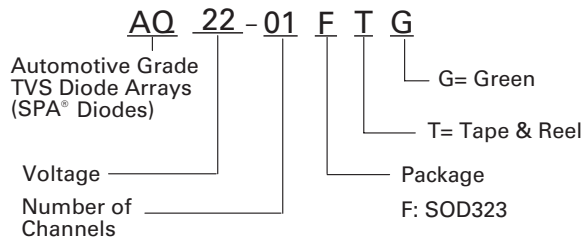

**Ordering Information**

| Part Number | Package | Min. Order Qty. |
|-------------|---------|-----------------|
| AQ22-01FTG  | SOD323  | 3000            |

**Part Marking System**

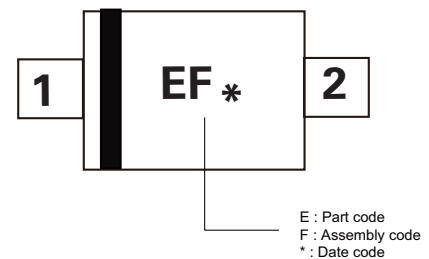

**Package Dimensions -SOD323**

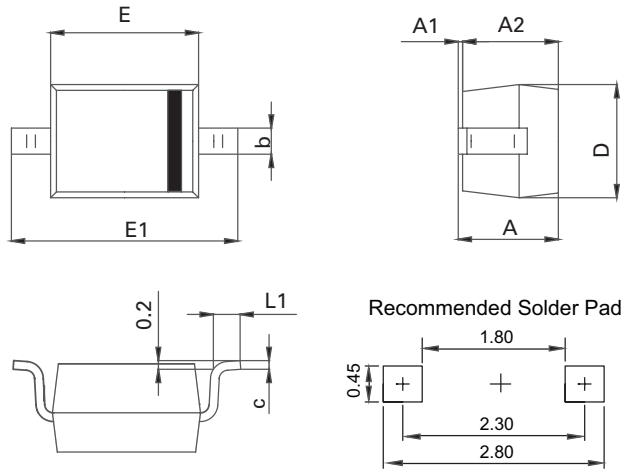

Unit: mm

| Symbol    | SOD323      |      |        |       |
|-----------|-------------|------|--------|-------|
|           | Millimeters |      | Inches |       |
|           | Min         | Max  | Min    | Max   |
| <b>A</b>  | -           | 1.00 | -      | 0.039 |
| <b>A1</b> | 0.00        | 0.10 | 0.000  | 0.004 |
| <b>A2</b> | 0.80        | 0.90 | 0.031  | 0.035 |
| <b>b</b>  | 0.25        | 0.35 | 0.010  | 0.014 |
| <b>c</b>  | 0.08        | 0.15 | 0.003  | 0.006 |
| <b>D</b>  | 1.20        | 1.40 | 0.047  | 0.055 |
| <b>E</b>  | 1.60        | 1.80 | 0.063  | 0.071 |
| <b>E1</b> | 2.50        | 2.70 | 0.098  | 0.106 |
| <b>L1</b> | 0.25        | 0.40 | 0.010  | 0.016 |

**Embossed Carrier Tape & Reel Specification – SOD323**

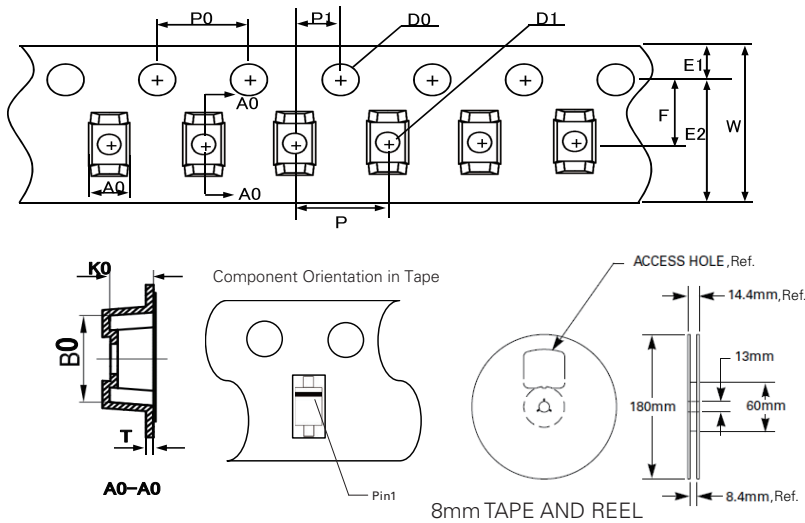

| Symbol    | Millimeters       |
|-----------|-------------------|
| <b>A0</b> | 1.36min/1.62max   |
| <b>B0</b> | 2.90+/-0.10       |
| <b>W</b>  | 8.0+0.3/-0.10     |
| <b>D0</b> | 1.50+0.10         |
| <b>D1</b> | ø1.00min/ø1.25max |
| <b>E</b>  | 1.75+/-0.10       |
| <b>E2</b> | -                 |
| <b>F</b>  | 3.50+/-0.05       |
| <b>P0</b> | 4.00+/-0.10       |
| <b>P</b>  | 4.00+/-0.10       |
| <b>P1</b> | 2.00+/-0.05       |
| <b>K0</b> | 1.15min/1.45max   |
| <b>T</b>  | 0.254+/-0.13      |

**Product Disclaimer:** Littelfuse products are not designed for, and shall not be used for, any purpose (including, without limitation, automotive, military, aerospace, medical, life-saving, life-sustaining or nuclear facility applications, devices intended for surgical implant into the body, or any other application in which the failure or lack of desired operation of the product may result in personal injury, death, or property damage) other than those expressly set forth in applicable Littelfuse product documentation. Warranties granted by Littelfuse shall be deemed void for products used for any purpose not expressly set forth in applicable Littelfuse documentation. Littelfuse shall not be liable for any claims or damages arising out of products used in applications not expressly intended by Littelfuse as set forth in applicable Littelfuse documentation. The sale and use of Littelfuse products is subject to Littelfuse Terms and Conditions of Sale, unless otherwise agreed by Littelfuse. "Littelfuse" includes Littelfuse, Inc., and all of its affiliate entities. <http://www.littelfuse.com/disclaimer-electronics>.