

1PMT5.0AT1G/T3G Series



**OBSOLETE/EOL**

DATE June/30/2018 PCN/ECN# LFPCN41246



**Maximum Ratings and Thermal Characteristics**

| Rating   | Symbol                                | Value             | Unit              |
|--|---------------------------------------|-------------------|-------------------|
| Maximum Ppk Dissipation, (PW=10/1000 $\mu$ s) (Note 1) (1PMT5.0A – 1PMT36A)                            | $P_{PK}$                              | 200               | W                 |
| Maximum Ppk Dissipation, (PW=10/1000 $\mu$ s) (Note 1) (1PMT40A – 1PMT58A)                             | $P_{PK}$                              | 175               | W                 |
| Maximum Ppk Dissipation, (PW=8/20 $\mu$ s) (Note 1)  | $P_{PK}$                              | 1000              | W                 |
| DC Power Dissipation @ TA = 25°C (Note 2) Derate above 25°C<br>Thermal Resistance, Junction-to-Ambient | $T_J, T_{stg}$                        | 500<br>4.0<br>248 | mW<br>mW/°C<br>°C |
| Thermal Resistance, Junction-to-Lead (Anode)   | $R_{\theta J\text{anode}}$            | 35                | °C/W              |
| Maximum DC Power Dissipation (Note 3)<br>Thermal Resistance, Junction-to-Tab (Cathode)                 | $P_D$<br>$R_{\theta J\text{cathode}}$ | 3.2<br>23         | W<br>°C/W         |
| Operating and Storage Temperature Range  | $T_J, T_{stg}$                        | -55 to +150       | °C                |

Stresses exceeding Maximum Ratings may damage the device. Maximum Ratings are stress ratings only. Functional operation above the Recommended Operating Conditions is not implied. Extended exposure to stresses above the Recommended Operating Conditions may affect device reliability.

1. Nonrepetitive current pulse at TA = 25°C.
2. Mounted with recommended minimum pad size, DC board FR-4.
3. At Tab (Cathode) temperature, Ttab = 75°C

**Description**

The 1PMT5.0AT1G/T3G Series is designed to protect voltage sensitive components from high voltage, high energy transients. Excellent clamping capability, high surge capability, low Zener impedance and fast response time. The advanced packaging technique provides for a highly efficient micro miniature, space saving surface mount with its unique heatsink design. It has the same thermal performance as the SMA while being 50% smaller in footprint area, and delivering one of the lowest height profiles (1.1 mm) in the industry. Because of its small size, it is ideal for use in cellular phones, portable devices, business machines, power supplies and many other industrial/consumer applications.

**Features**

- Stand-off Voltage: 5.0 V – 58 V
- Peak Power
  - 200 W @ 1 ms (1PMT5.0A – 1PMT36A)
  - 175 W @ 1 ms (1PMT40A – 1PMT58A)
- Maximum Clamp Voltage @ Peak Pulse Current
- Low Leakage
- Response Time is Typically < 1 ns
- ESD Rating of Class 3 (> 16 kV) per Human Body Model
- Low Profile – Maximum Height of 1.1 mm
- Integral Heatsink/Locking Tabs
- Full Metallic Bottom Eliminates Flux Entrapment
- Small Footprint – Footprint Area of 8.45 mm<sup>2</sup>
- Lead Orientation in Tape: Cathode (Short) Lead to Sprocket Holes
- Cathode Indicated by Polarity Band
- These Devices are Pb-Free and are RoHS Compliant

**Functional Diagram**

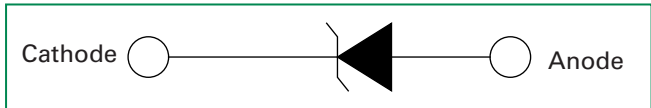

**Additional Information**



Datasheet



Resources



Samples

**I-V Curve Characteristics** ( $T_A = 25^\circ\text{C}$  unless otherwise noted)

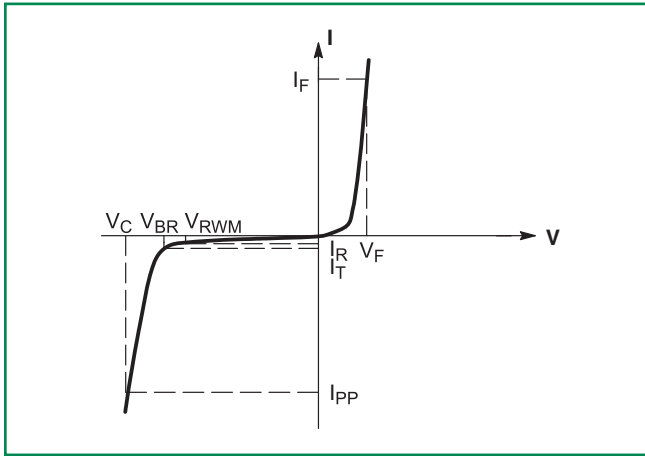

| Symbol    | Parameter                                   |
|-----------|---|
| $I_{PP}$  | Maximum Reverse Peak Pulse Current          |
| $V_C$     | Clamping Voltage @ $I_{PP}$                 |
| $V_{RWM}$ | Working Peak Reverse Voltage                |
| $I_R$     | Maximum Reverse Leakage Current @ $V_{RWM}$ |
| $V_{BR}$  | Breakdown Voltage @ $I_T$                   |
| $I_T$     | Test Current                                |
| $I_F$     | Forward Current                             |
| $V_F$     | Forward Voltage @ $I_F$                     |

**Ratings and Characteristic Curves**

**Figure 1. Pulse Rating Curve**

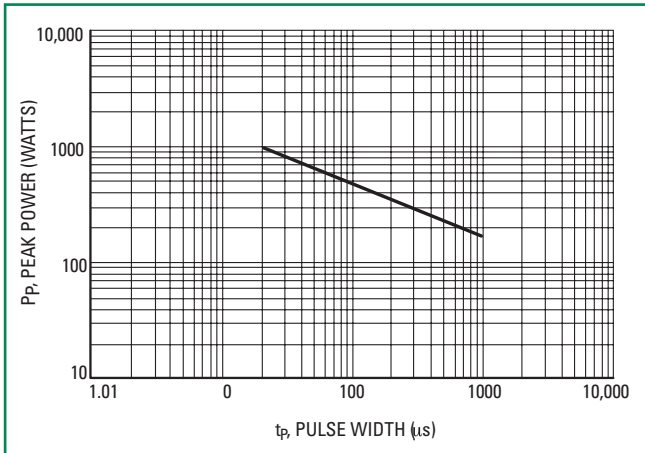

**Figure 2. 10 X 1000 μs Pulse Waveform**

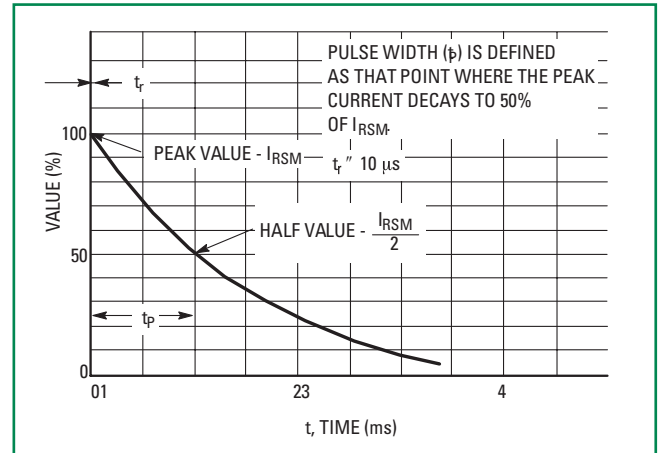

**Figure 3. 8 X 20 μs Pulse Waveform**

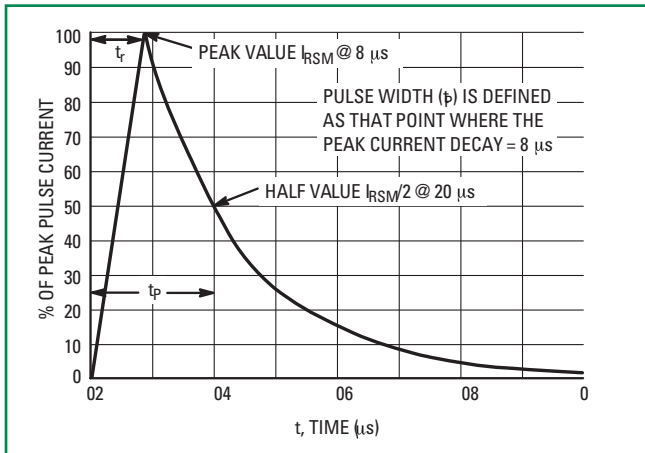

**Figure 4. Pulse Derating Curve**

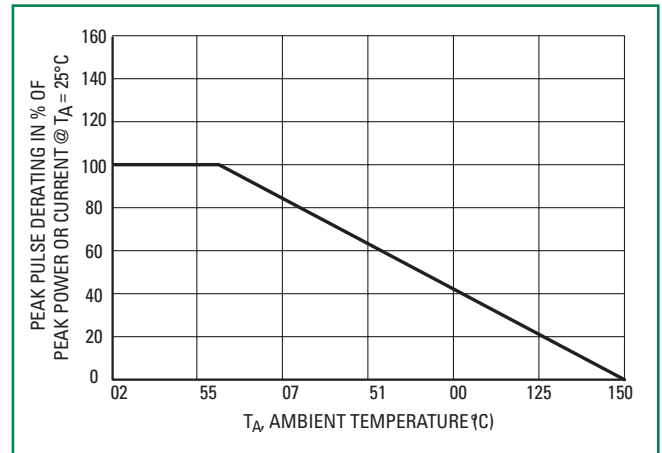

**Figure 5. Typical Derating Factor for Duty Cycle**

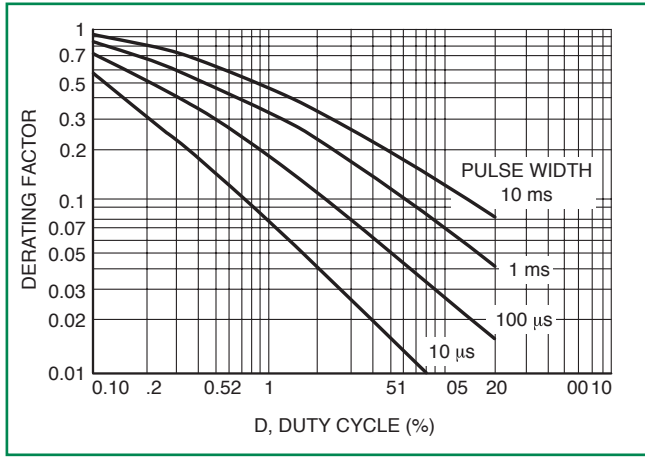

**Figure 6. Steady State Power Derating**

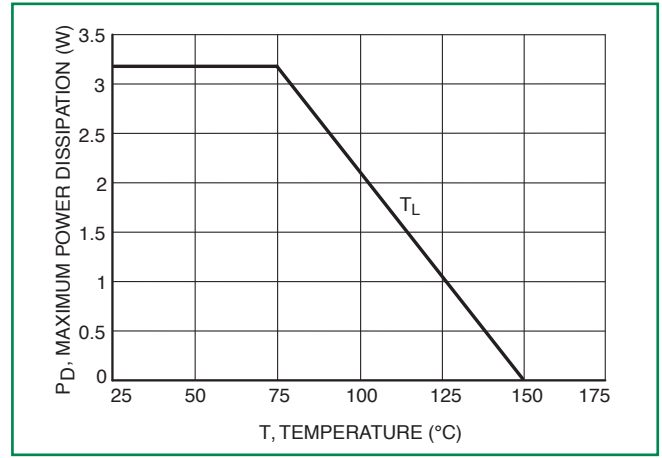

**Figure 7. Forward Voltage**

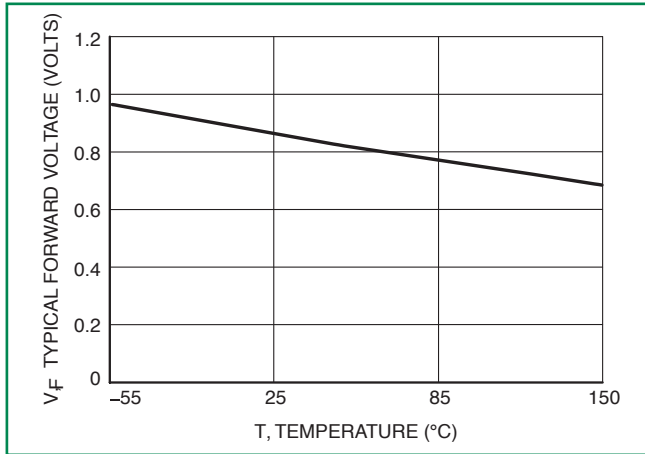

**Figure 8. Capacitance vs. Working Peak Reverse Voltage**

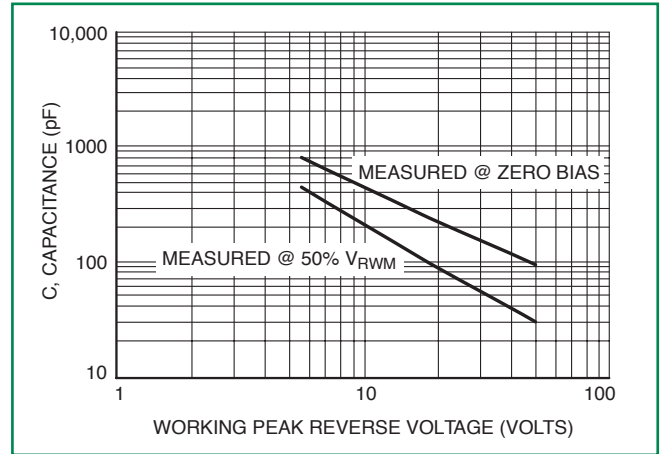

**Typical Protection Circuit**

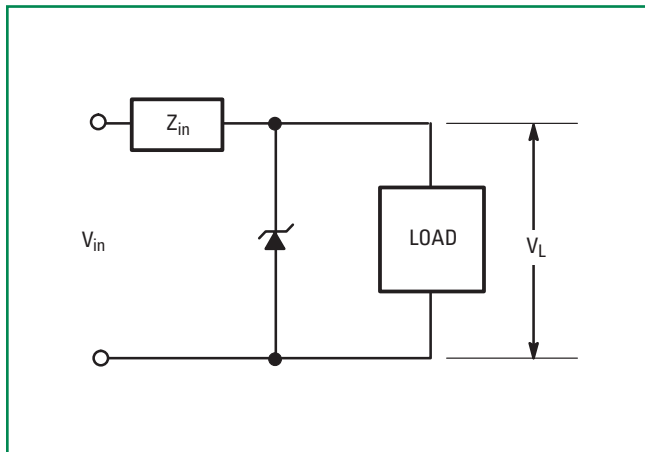

**Electrical Characteristics (TL = 30 °C unless otherwise noted, VF = 1.25 Volts @ 200 mA)**

| Device*          | Device Marking | V <sub>RWM</sub> | V <sub>BR</sub> @ I <sub>T</sub> (V) (Note 6) |       |      | I <sub>T</sub> | I <sub>R</sub> @ V <sub>RWM</sub> | V <sub>C</sub> @ I <sub>PP</sub> | I <sub>PP</sub> (A) |
|------------------|----------------|------------------|---|-------|------|----------------|-----------------------------------|----------------------------------|---------------------|
|                  |                | (Note 5)         | MIN   | NOM   | MAX  | (mA)           | (μA)                              | (V)                              | (Note 7)            |
| 1PMT5.0AT1G, T3G | MKE            | 5.0              | 6.4   | 6.7   | 7.0  | 10             | 50                                | 9.2                              | 21.7                |
| 1PMT7.0AT1G, T3G | MKM            | 7.0              | 7.78  | 8.2   | 8.6  | 10             | 30                                | 12                               | 16.7                |
| 1PMT12AT1G, T3G  | MLE            | 12               | 13.3  | 14.0  | 14.7 | 1.0            | 1.0                               | 19.9                             | 10.1                |
| 1PMT16AT1G, T3G  | MLP            | 16               | 17.8  | 18.75 | 19.7 | 1.0            | 1.0                               | 26                               | 7.7                 |
| 1PMT18AT1G, T3G  | MLT            | 18               | 20.0  | 21.0  | 22.1 | 1.0            | 1.0                               | 29.2                             | 6.8                 |
| 1PMT22AT1G, T3G  | MLX            | 22               | 24.4  | 25.6  | 26.9 | 1.0            | 1.0                               | 35.5                             | 5.6                 |
| 1PMT24AT1G, T3G  | MLZ            | 24               | 26.7  | 28.1  | 29.5 | 1.0            | 1.0                               | 38.9                             | 5.1                 |
| 1PMT26AT1G, T3G  | MME            | 26               | 28.9  | 30.4  | 31.9 | 1.0            | 1.0                               | 42.1                             | 4.8                 |
| 1PMT28AT1G, T3G  | MMG            | 28               | 31.1  | 32.8  | 34.4 | 1.0            | 1.0                               | 45.4                             | 4.4                 |
| 1PMT30AT1G, T3G  | MMK            | 30               | 33.3  | 35.1  | 36.8 | 1.0            | 1.0                               | 48.4                             | 4.1                 |
| 1PMT33AT1G, T3G  | MMM            | 33               | 36.7  | 38.7  | 40.6 | 1.0            | 1.0                               | 53.3                             | 3.8                 |
| 1PMT36AT1G, T3G  | MMP            | 36               | 40.0  | 42.1  | 44.2 | 1.0            | 1.0                               | 58.1                             | 3.4                 |
| 1PMT40AT1G, T3G  | MMR            | 40               | 44.4  | 46.8  | 49.1 | 1.0            | 1.0                               | 64.5                             | 2.7                 |
| 1PMT48AT1G, T3G  | MMX            | 48               | 53.3  | 56.1  | 58.9 | 1.0            | 1.0                               | 77.4                             | 2.3                 |
| 1PMT51AT1G, T3G  | MMZ            | 51               | 56.7  | 59.7  | 62.7 | 1.0            | 1.0                               | 82.4                             | 2.1                 |
| 1PMT58AT1G, T3G  | MNG            | 58               | 64.4  | 67.8  | 71.2 | 1.0            | 1.0                               | 93.6                             | 1.9                 |

4. 1/2 sine wave (or equivalent square wave), PW = 8.3 ms, duty cycle = 4 pulses per minute maximum.

5. A transient suppressor is normally selected according to the Working Peak Reverse Voltage (VRWM) which should be equal to or greater than the DC or continuous peak operating voltage level.

6. VBR measured at pulse test current IT at ambient temperature of 25°C.

7. Surge current waveform per Figure 2 and derate per Figure 4.

\*The "G" suffix indicates Pb-Free package.

**Dimensions**

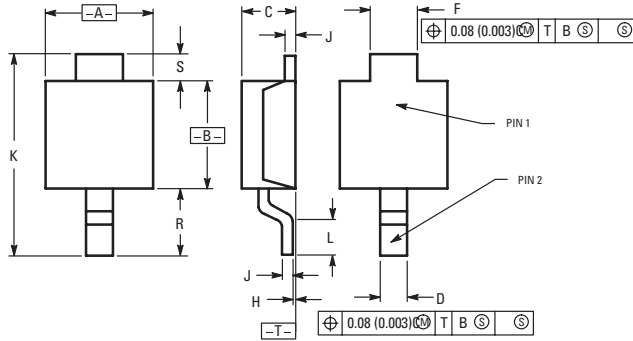

| Dim | Inches   |        | Millimeters |       |
|-----|----------|--------|-------------|-------|
|     | Min      | Max    | Min         | Max   |
| A   | 0.069    | 0.081  | 1.75        | 2.05  |
| B   | 0.069    | 0.086  | 1.75        | 2.18  |
| C   | 0.033    | 0.045  | 0.85        | 1.15  |
| D   | 0.016    | 0.027  | 0.40        | 0.69  |
| F   | 0.028    | 0.039  | 0.70        | 1.00  |
| H   | -0.002   | +0.004 | -0.05       | +0.10 |
| J   | 0.004    | 0.010  | 0.10        | 0.25  |
| K   | 0.142    | 0.154  | 3.60        | 3.90  |
| L   | 0.020    | 0.031  | 0.50        | 0.80  |
| R   | 0.047    | 0.059  | 1.20        | 1.50  |
| S   | 0.50 REF |        | 0.50 REF    |       |

- NOTES:
1. DIMENSIONING AND TOLERANCING PER ANSI Y14.5M, 1982.
  2. CONTROLLING DIMENSION: MILLIMETER.
  3. DIMENSIONS A AND B DO NOT INCLUDE MOLD FLASH, PROTRUSIONS OR GATE BURRS. MOLD FLASH, PROTRUSIONS OR GATE BURRS

**Part Marking System**

**MARKING DIAGRAM**

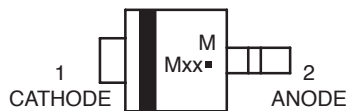

- M= Date Code
- Mxx= Specific Device Code (See Table on Page 3)
- =P b-Free Package

**Soldering Footprint**

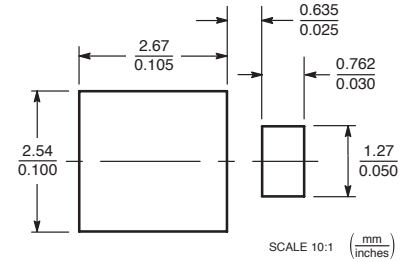

**ORDERING INFORMATION**

| Device     | Package             | Shipping†            |
|------------|---------------------|----------------------|
| 1PMTxxAT1G | POWERMITE (Pb-Free) | 3,000 / Tape & Reel  |
| 1PMTxxAT3G | POWERMITE (Pb-Free) | 12,000 / Tape & Reel |

**Flow/Wave Soldering (Solder Dipping)**

|                           |            |
|---------------------------|------------|
| <b>Peak Temperature :</b> | 260°C      |
| <b>Dipping Time :</b>     | 10 seconds |

**Physical Specifications**

|                          |  |
|--------------------------|--|
| <b>Case</b>              | Void-free, transfer-molded, thermosetting plastic                              |
| <b>Leads</b>             | Modified L-Bend providing more contact area to bond pads                       |
| <b>Finish</b>            | All external surfaces are corrosion resistant and leads are readily solderable |
| <b>Mounting Position</b> | Any  |

**Disclaimer Notice** - Information furnished is believed to be accurate and reliable. However, users should independently evaluate the suitability of and test each product selected for their own applications. Littelfuse products are not designed for, and may not be used in, all applications. Read complete Disclaimer Notice at: [www.littelfuse.com/disclaimer-electronics](http://www.littelfuse.com/disclaimer-electronics).