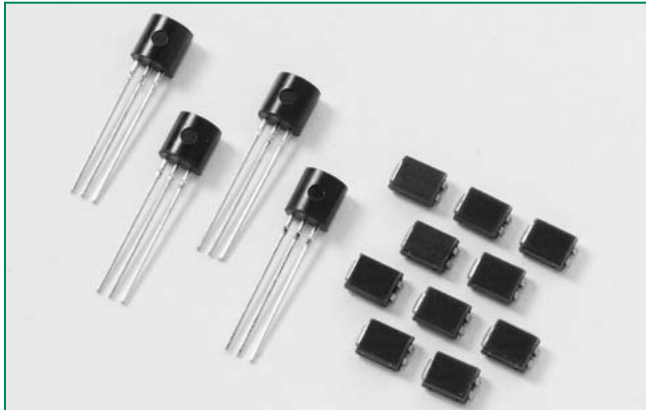

TCR22-x & Sx02CSx series

Description

Excellent unidirectional switches for phase control applications such as heating and motor speed controls. Sensitive gate SCRs are easily triggered with microAmps of current as furnished by sense coils, proximity switches, and microprocessors.

Features & Benefits

- RoHS compliant
- Glass – passivated junctions
- Voltage capability up to 600 V
- Surge capability up to 20 A

Main Features

Symbol	Value	Unit
$I_{T(RMS)}$	1.5	A
V_{DRM}/V_{RRM}	400 or 600	V
I_{GT}	200	μA

Applications

Typical applications are capacitive discharge systems for strobe lights and gas engine ignition. Also controls for power tools, home/brown goods and white goods appliances.

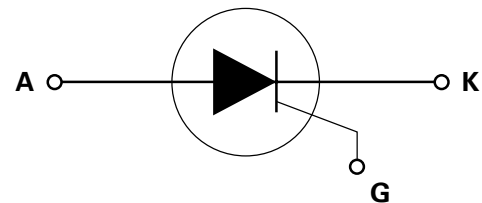
Schematic Symbol

Absolute Maximum Ratings – Sensitive SCRs

Symbol	Parameter	Test Conditions	Value	Unit
$I_{T(RMS)}$	RMS on-state current	$T_C = 40^\circ C$	1.5	A
$I_{T(AV)}$	Average on-state current	$T_C = 40^\circ C$	0.95	A
I_{TSM}	Peak non-repetitive surge current	single half cycle; $f = 50\text{Hz}$; $T_J(\text{initial}) = 25^\circ C$	16	A
		single half cycle; $f = 60\text{Hz}$; $T_J(\text{initial}) = 25^\circ C$	20	
I^2t	I^2t Value for fusing	$t_p = 8.3\text{ ms}$	1.6	A^2s
di/dt	Critical rate of rise of on-state current	$f = 60\text{ Hz}$; $T_J = 110^\circ C$	50	$A/\mu s$
I_{GM}	Peak gate current	$T_J = 110^\circ C$	1	A
$P_{G(AV)}$	Average gate power dissipation	$T_J = 110^\circ C$	0.1	W
T_{stg}	Storage temperature range		-40 to 150	$^\circ C$
T_J	Operating junction temperature range		-40 to 110	$^\circ C$

Electrical Characteristics ($T_J = 25^\circ\text{C}$, unless otherwise specified)

Symbol	Test Conditions		Value	Unit	
I_{GT}	$V_D = 6\text{V}; R_L = 100\ \Omega$	MAX.	200	μA	
V_{GT}		MAX.	0.8	V	
dv/dt	$V_D = V_{DRM}; R_{GK} = 1\text{k}\Omega$	400V	MIN.	40	V/ μs
		600V		30	
V_{GD}	$V_D = V_{DRM}; R_L = 3.3\ \text{k}\Omega; T_J = 110^\circ\text{C}$	MIN.	0.25	V	
V_{GRM}	$I_{GR} = 10\ \mu\text{A}$	MIN.	6	V	
I_H	$I_T = 200\text{mA}$ (initial)	MAX.	5	mA	
t_g	(1)	MAX.	50	μs	
t_{gt}	$I_G = 2 \times I_{GT}; \text{PW} = 15\ \mu\text{s}; I_T = 3\text{A}$	TYP.	20	μs	

(1) $I_T = 1\text{A}; t_p = 50\ \mu\text{s}; \text{dv/dt} = 5\text{V}/\mu\text{s}; \text{di/dt} = -10\text{A}/\mu\text{s}$

Static Characteristics

Symbol	Test Conditions	Value	Unit		
V_{TM}	$I_T = 3\text{A}; t_p = 380\ \mu\text{s}$	MAX.	1.5	V	
I_{DRM} / I_{RRM}	$V_{DRM} = V_{RRM}$	$T_J = 25^\circ\text{C}$	400V	1	μA
			600V	2	
		$T_J = 110^\circ\text{C}$	100		

Thermal Resistances

Symbol	Parameter		Value	Unit
$R_{\theta(JC)}$	Junction to case (AC)	TCR22-x	50	$^\circ\text{C}/\text{W}$
		Sx02CSx	60*	
$R_{\theta(J-A)}$	Junction to ambient	TCR22-x	160	$^\circ\text{C}/\text{W}$

*=Mount on 1 cm² copper (two-ounce) foil surface

Figure 1: Normalized DC Gate Trigger Current vs. Junction Temperature

Figure 2: Normalized DC Gate Trigger Voltage vs. Junction Temperature

Figure 3: Normalized DC Holding Current vs. Junction Temperature

Figure 4: Normalized DC Latching Current vs. Junction Temperature

Figure 5: On-State Current vs. On-State Voltage (Typical)

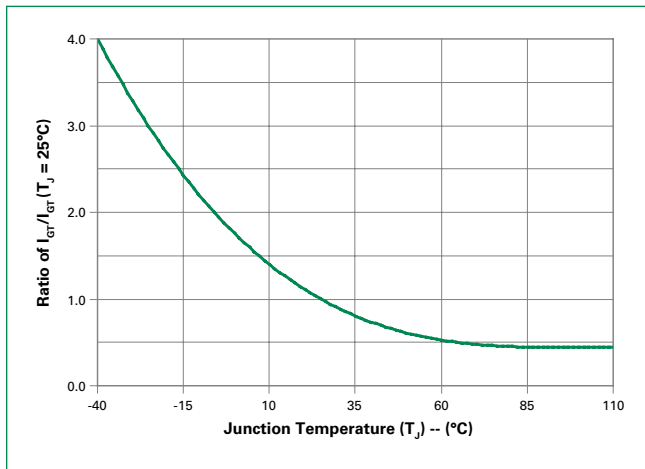
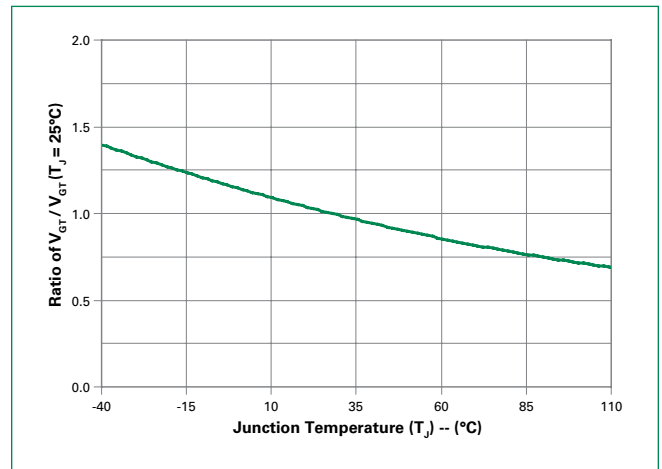
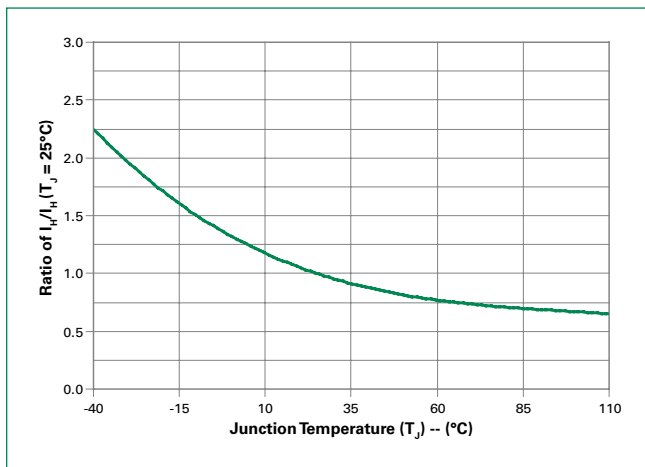
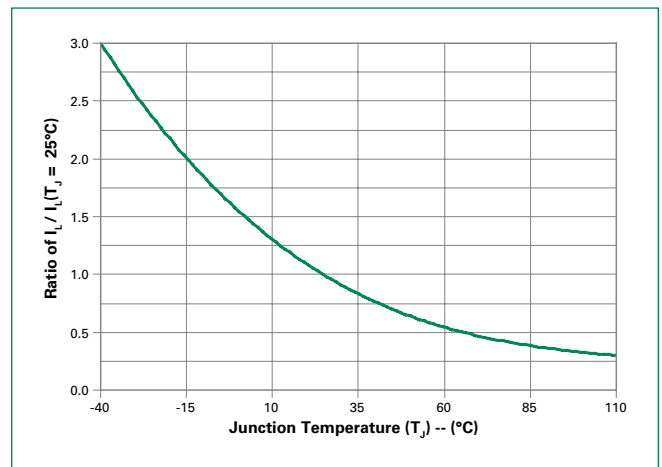
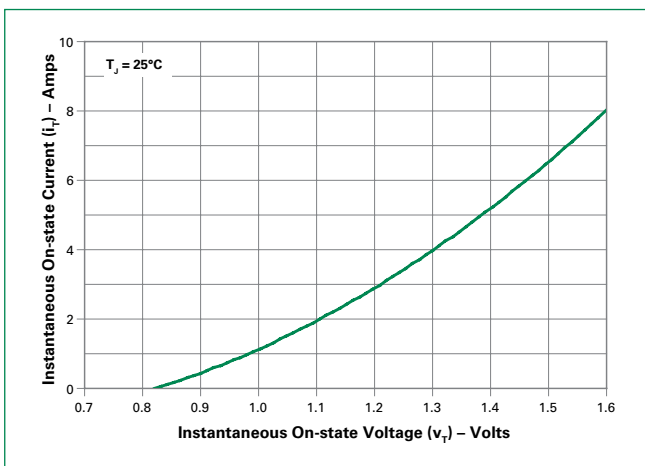
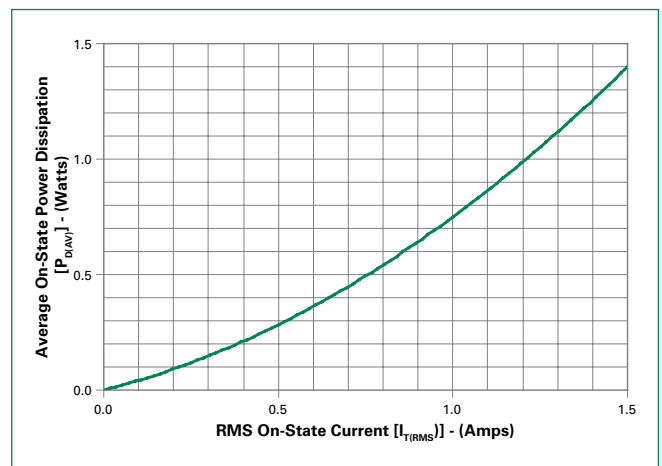
Figure 6: Power Dissipation (Typical) vs. RMS On-State Current

Figure 7: Maximum Allowable Case Temperature vs. RMS On-State Current

Figure 8: Maximum Allowable Case Temperature vs. Average On-State Current

Figure 9: Maximum Allowable Ambient Temperature vs. RMS On-State Current

Figure 10: Maximum Allowable Ambient Temperature vs. Average On-State Current

Figure 11: Peak Repetitive Capacitor Discharge Current

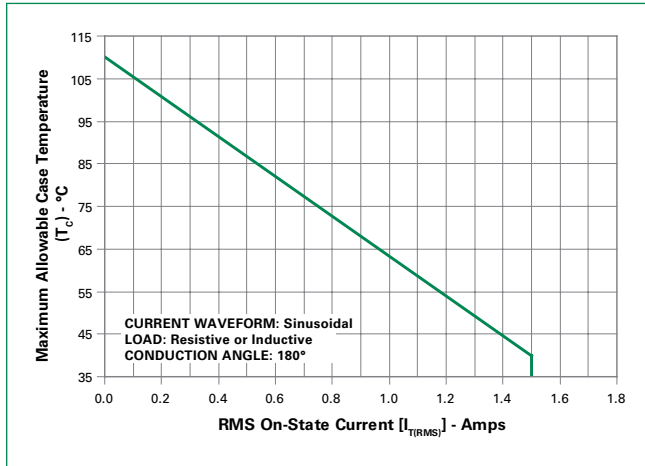
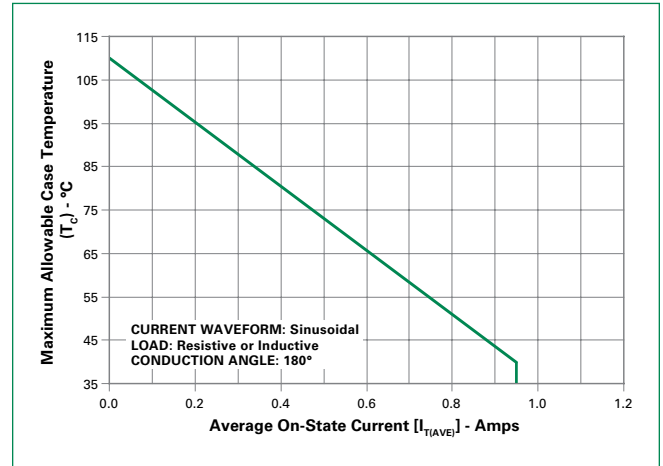
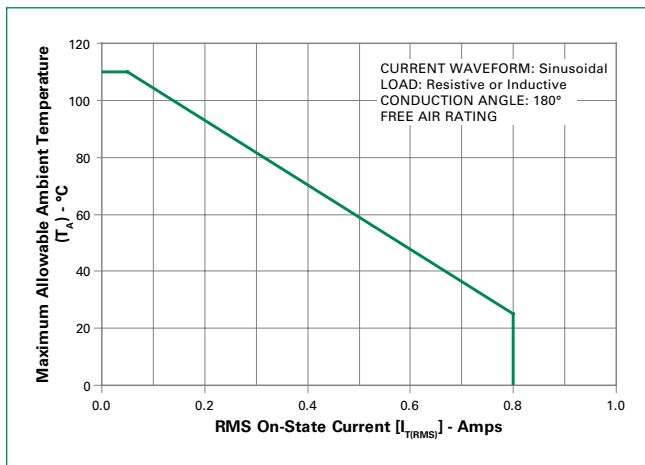
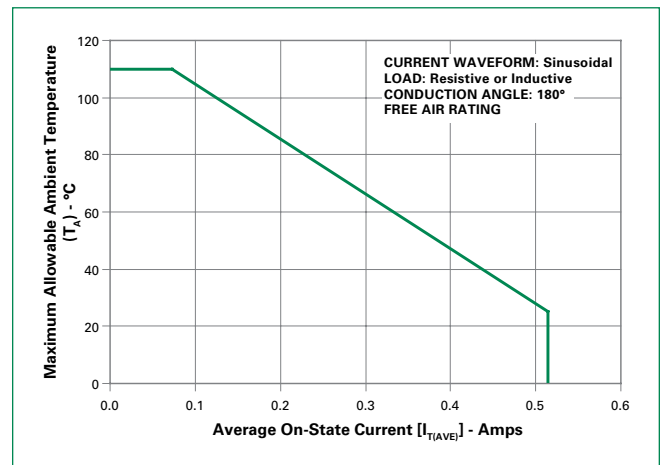
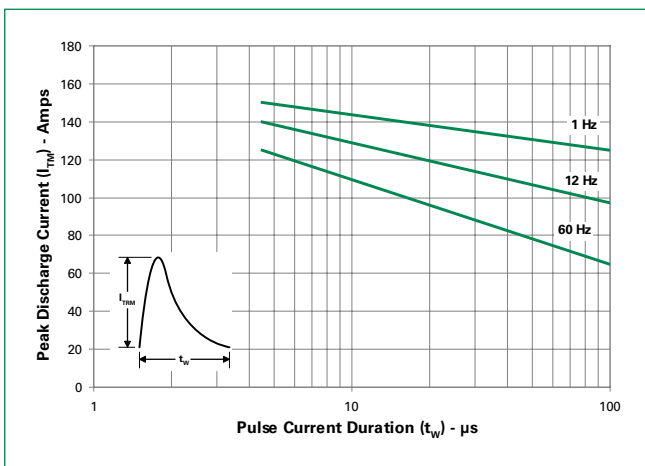
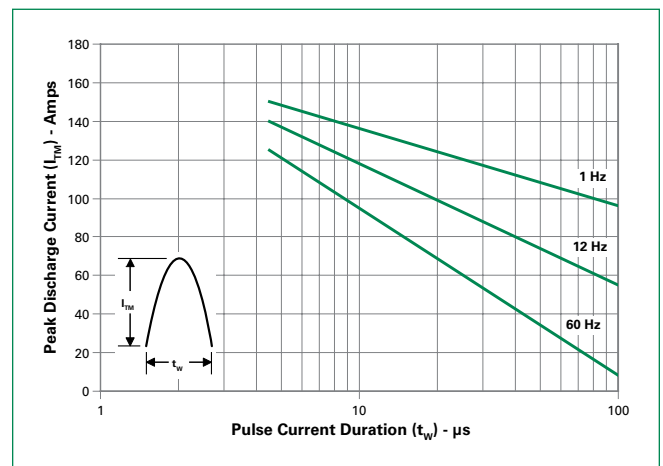
Figure 12: Peak Repetitive Sinusoidal Pulse Current

Figure 13: Typical DC Gate Trigger Current with R_{GK} vs. Junction Temperature for TCR22-8/S602CS

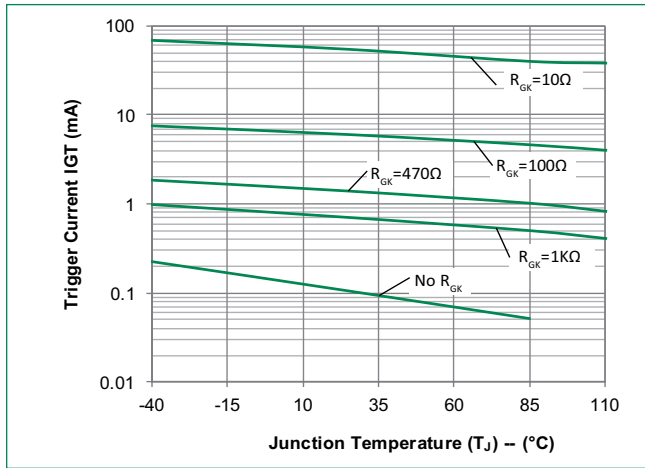

Figure 14: Typical DC Holding Current with R_{GK} vs. Junction Temperature for TCR22-8/S602CS

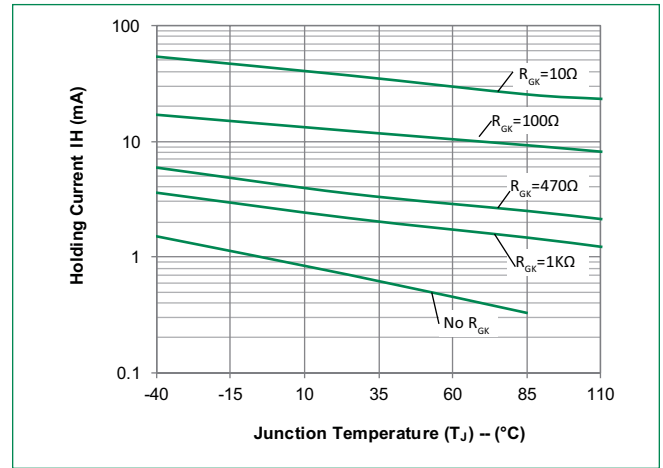

Figure 15: Typical Static dv/dt with R_{GK} vs. Junction Temperature for TCR22-8/S602CS

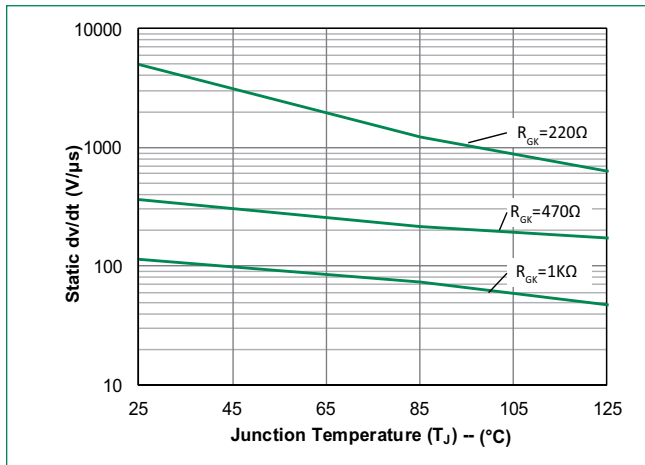

Figure 16: Typical turn off time with R_{GK} vs. Junction Temperature for TCR22-8/S602CS

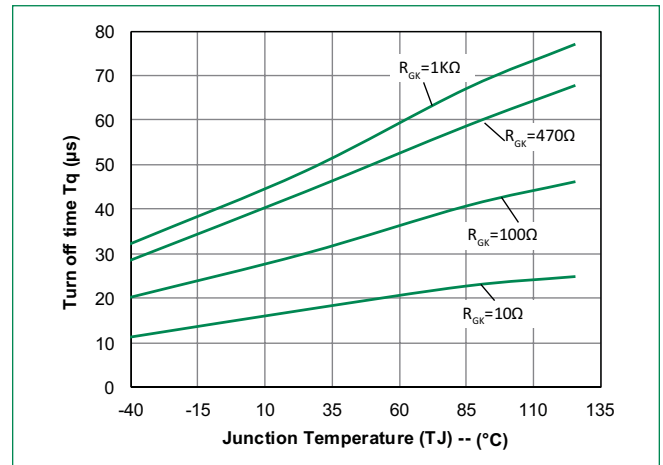
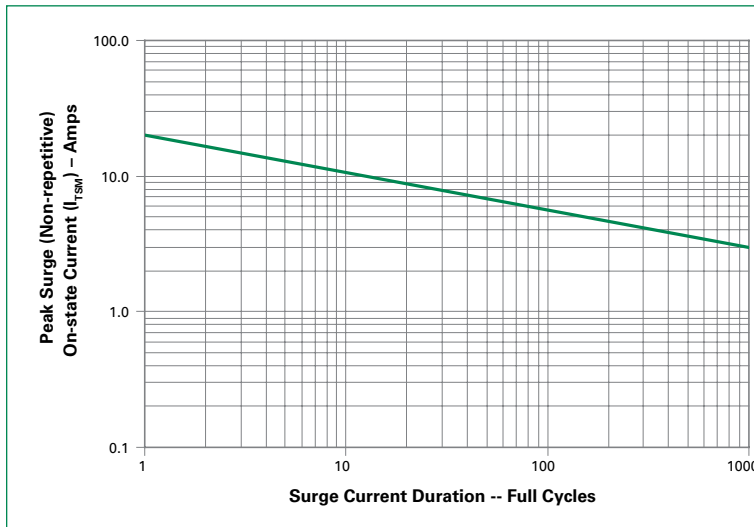

Figure 17: Surge Peak On-State Current vs. Number of Cycles



SUPPLY FREQUENCY: 60 Hz Sinusoidal
 LOAD: Resistive
 RMS On-State Current: I_{T(RMS)}: Maximum Rated Value at Specified Case Temperature

Notes:

1. Gate control may be lost during and immediately following surge current interval.
2. Overload may not be repeated until junction temperature has returned to steady-state rated value.

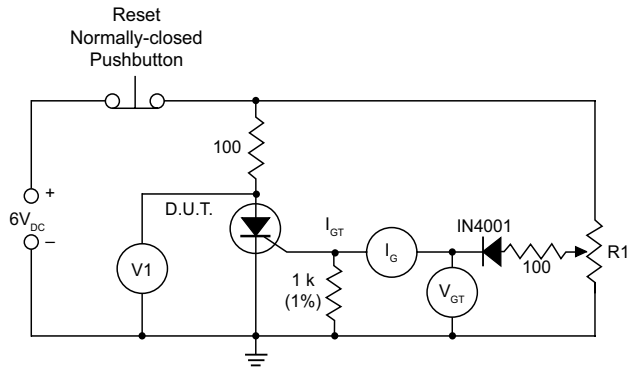
Figure 18: Simple Test Circuit for Gate Trigger Voltage and Current

Note: V1 — 0 V to 10 V dc meter
 V_{GT} — 0 V to 1 V dc meter
 I_G — 0 mA to 1 mA dc milliammeter
 R1 — 1 k potentiometer

To measure gate trigger voltage and current, raise gate voltage (V_{GT}) until meter reading V1 drops from 6 V to 1 V. Gate trigger voltage is the reading on V_{GT} just prior to V1 dropping. Gate trigger current I_{GT} can be computed from the relationship

$$I_{GT} = I_G \frac{V_{GT}}{1000} \text{ Amps}$$

where I_G is reading (in amperes) on meter just prior to V1 dropping

Note: I_{GT} may turn out to be a negative quantity (trigger current flows out from gate lead). If negative current occurs, I_{GT} value is not a valid reading. Remove 1 k resistor and use I_G as the more correct I_{GT} value. This will occur on 12 μA gate products.

Soldering Parameters

Reflow Condition		Pb – Free assembly
Pre Heat	-Temperature Min (T _{s(min)})	150°C
	-Temperature Max (T _{s(max)})	200°C
	-Time (min to max) (t _s)	60 – 180 secs
Average ramp up rate (Liquidus Temp (T _L) to peak)		5°C/second max
T _{s(max)} to T _L - Ramp-up Rate		5°C/second max
Reflow	-Temperature (T _L) (Liquidus)	217°C
	-Time (t _r)	60 – 150 seconds
Peak Temperature (T _p)		260 ^{+0/-5} °C
Time within 5°C of actual peak Temperature (t _p)		20 – 40 seconds
Ramp-down Rate		5°C/second max
Time 25°C to peak Temperature (T _p)		8 minutes Max.
Do not exceed		280°C

Physical Specifications

Terminal Finish	100% Matt Tin-plated/Pb-free Solder Dipped
Body Material	UL Recognized compound meeting flammability rating V-0
Lead Material	Copper Alloy

Design Considerations

Careful selection of the correct component for the application's operating parameters and environment will go a long way toward extending the operating life of the Thyristor. Good design practice should limit the maximum continuous current through the main terminals to 75% of the component rating. Other ways to ensure long life for a power discrete semiconductor are proper heat sinking and selection of voltage ratings for worst case conditions. Overheating, overvoltage (including dv/dt), and surge currents are the main killers of semiconductors. Correct mounting, soldering, and forming of the leads also help protect against component damage.

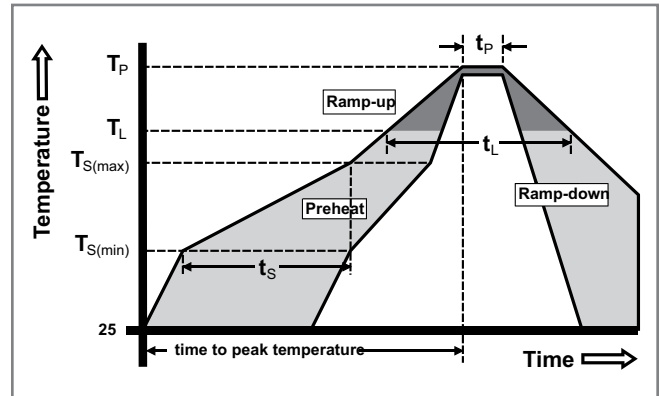

Environmental Specifications

Test	Specifications and Conditions
AC Blocking	MIL-STD-750, M-1040, Cond A Applied Peak AC voltage @ 110°C for 1008 hours
Temperature Cycling	MIL-STD-750, M-1051, 100 cycles; -40°C to +150°C; 15-min dwell-time
Temperature/Humidity	EIA / JEDEC, JESD22-A101 1008 hours; 160V - DC; 85°C; 85% rel humidity
High Temp Storage	MIL-STD-750, M-1031, 1008 hours; 150°C
Low-Temp Storage	1008 hours; -40°C
Resistance to Solder Heat	MIL-STD-750 Method 2031
Solderability	ANSI/J-STD-002, category 3, Test A
Lead Bend	MIL-STD-750, M-2036 Cond E

Dimensions – TO-92 (E Package)

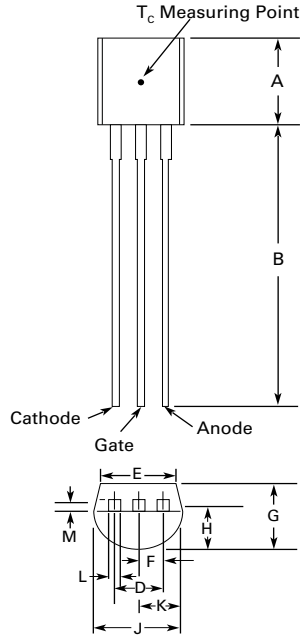

Dimension	Inches		Millimeters	
	Min	Max	Min	Max
A	0.176	0.196	4.47	4.98
B	0.500		12.70	
D	0.095	0.105	2.41	2.67
E	0.150		3.81	
F	0.046	0.054	1.16	1.37
G	0.135	0.145	3.43	3.68
H	0.088	0.096	2.23	2.44
J	0.176	0.186	4.47	4.73
K	0.088	0.096	2.23	2.44
L	0.013	0.019	0.33	0.48
M	0.013	0.017	0.33	0.43

All leads insulated from case. Case is electrically nonconductive.

Dimensions – Compak (C Package)

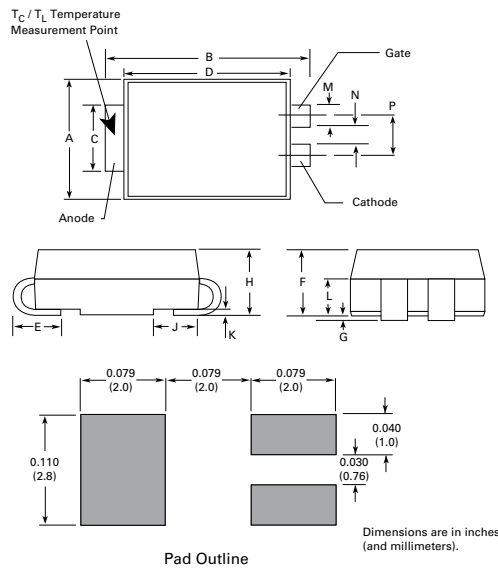

Dimension	Inches		Millimeters	
	Min	Max	Min	Max
A	0.130	0.156	3.30	3.95
B	0.201	0.220	5.10	5.60
C	0.077	0.087	1.95	2.20
D	0.159	0.181	4.05	4.60
E	0.030	0.063	0.75	1.60
F	0.075	0.096	1.90	2.45
G	0.002	0.008	0.05	0.20
H	0.077	0.104	1.95	2.65
J	0.043	0.053	1.09	1.35
K	0.006	0.016	0.15	0.41
L	0.030	0.055	0.76	1.40
M	0.022	0.028	0.56	0.71
N	0.027	0.033	0.69	0.84
P	0.052	0.058	1.32	1.47

Product Selector

Part Number	Voltage		Gate Sensitivity	Type	Package
	400V	600V			
TCR22-6	X		200μA	Sensitive SCR	TO-92
TCR22-8		X	200μA	Sensitive SCR	TO-92
Sx02CS		X	200μA	Sensitive SCR	Compak

Note: x = Voltage

Packing Options

Part Number	Marking	Weight	Packing Mode	Base Quantity
TCR22-x	TCR22-x	0.19 g	Bulk	2000
TCR22-xRP	TCR22-x	0.19 g	Reel Pack	2000
TCR22-xAP	TCR22-x	0.19 g	Ammo Pack	2000
Sx02CSR	Sx02CS	0.18 g	Reel Pack	2500

Note: x = Voltage

Part Numbering System

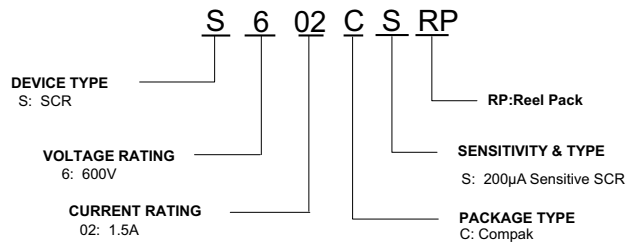
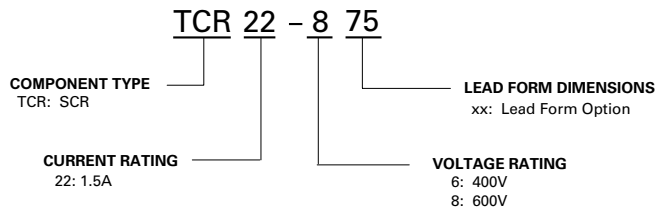

Part Marking System

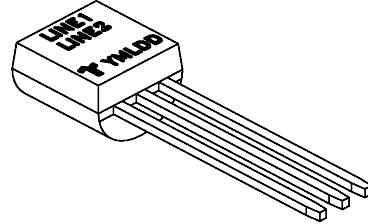

Line1 = Littelfuse Part Number
 Line2 = continuation...Littelfuse Part Number
 Y = Last Digit of Calendar Year
 M = Letter Month Code (A-L for Jan-Dec)
 L = Location Code
 DD = Calendar Date



Date Code Marking
 Y: Year Code
 M: Month Code
 XXX: Lot Trace Code

Compak Embossed Carrier Reel Pack (RP) Specifications

Meets all EIA-481-1 Standards

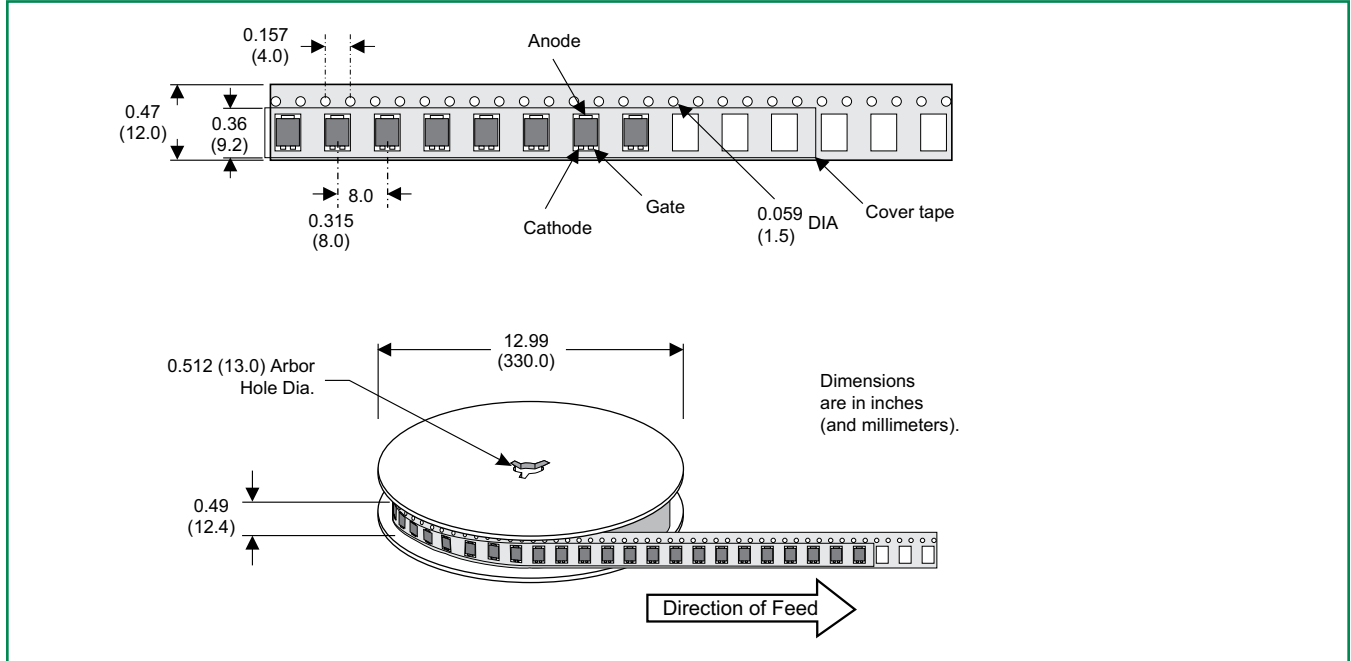

Disclaimer Notice - Information furnished is believed to be accurate and reliable. However, users should independently evaluate the suitability of and test each product selected for their own applications. Littelfuse products are not designed for, and may not be used in, all applications. Read complete Disclaimer Notice at <http://www.littelfuse.com/disclaimer-electronics>.