

# SxX8xSx EV Series

## 0.8 A Sensitive SCRs

HF RoHS

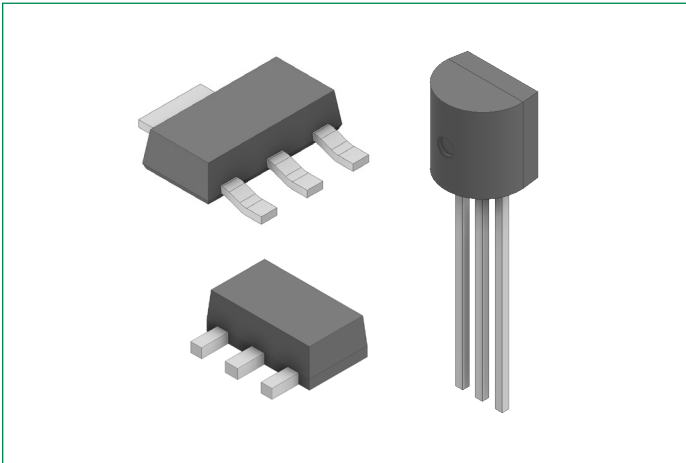

### Pinout Diagram

TO-92

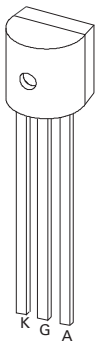

SOT-223

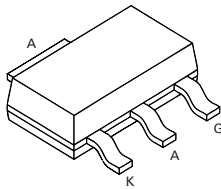

SOT-89

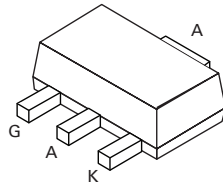

A: Anode; K: Cathode; G: Gate

### Description:

This new component series offers high static  $dv/dt$  and low turn off time ( $t_q$ ) sensitive SCR. It is specifically designed for Ground Fault Circuit Interrupter (GFCI) and gas ignition applications. All SCR junctions are glass-passivated to ensure long term reliability and parametric stability.

### Features:

- RoHS compliant and halogen-free
- Through-hole and surface mount packages
- Blocking voltage ( $V_{DRM} / V_{RRM}$ ) capability up to 800 V
- High  $dv/dt$  noise immunity
- Surge current capability > 10 A
- Improved turn-off time ( $t_q$ ) < 25  $\mu$ s
- Sensitive gate for direct microprocessor interface

### Applications:

- Ground Fault Circuit Interrupter (GFCI) applications
- Gas ignition applications

### Product Summary

Characteristic	Value	Unit
$I_{T(RMS)}$	0.8	A
$V_{DRM} / V_{RRM}$	400, 600, or 800	V
$I_{GT(Q1)}$	5 to 450	$\mu$ A

## Maximum Ratings

Symbol	Characteristics	Conditions		Value	Units
$I_{T(RMS)}$	On-state RMS Current	TO-92	$T_C = 55\text{ °C}$	0.8	A
		SOT-89	$T_C = 60\text{ °C}$		
		SOT-223	$T_L = 60\text{ °C}$		
$I_{T(AV)}$	Average On-state Current	TO-92	$T_C = 55\text{ °C}$	0.51	A
		SOT-89	$T_C = 60\text{ °C}$		
		SOT-223	$T_L = 60\text{ °C}$		
$I_{TSM}$	Non-repetitive Surge Peak On-state Current	TO-92 SOT-89 SOT-223	f = 50 Hz, t = 20 ms	8	A
			f = 60 Hz, t = 16.7 ms		
$I^2t$	$I^2t$ Value for Fusing	$t_p = 10\text{ ms}$	f = 50 Hz	0.32	A <sup>2</sup> s
		$t_p = 8.3\text{ ms}$	f = 60 Hz	0.41	
di/dt	Critical Rate of Rise of On-state Current	TO-92 SOT-89 SOT-223	$I_G = 10\text{ mA}$ , $T_{vj} = 125\text{ °C}$	50	A/μs
$I_{GM}$	Peak Gate Current	$t_p = 10\text{ μs}$	$T_{vj} = 125\text{ °C}$	1	A
$P_{G(AV)}$	Average Gate Power Dissipation	$T_{vj} = 125\text{ °C}$		1	W
$T_{stg}$	Storage Temperature Range	-		-40 to 150	°C
$T_{vj}$	Virtual Junction Temperature Range	-		-40 to 125	°C

Electrical Characteristics ( $T_{vj} = 25\text{ °C}$ , unless otherwise specified)

Symbol	Characteristics	Conditions	Limit	Value				Units
				SxX8yS1	SxX8yS2	SxX8yS	SxX8yS3	
$I_{GT}$	DC Gate Trigger Current	$V_D = 6\text{ V}$ , $R_L = 100\text{ Ω}$	Min.	0.5	1	15	70	μA
			Max.	5	50	200	450	
$V_{GT}$	DC Gate Trigger Voltage	$V_D = 6\text{ V}$ , $R_L = 100\text{ Ω}$	Max.	0.8				V
$V_{GRM}$	Peak Reverse Gate Voltage	$I_{RG} = 10\text{ μA}$	Min.	5				V
$V_{GD}$	Gate Non-trigger Voltage	$V_D = V_{DRM}$ , $R_{GK} = 1\text{ kΩ}$ , $T_{vj} = 125\text{ °C}$	Min.	0.2				V
$I_H$	Holding Current	$R_{GK} = 1\text{ kΩ}$ , Initial current = 20 mA	Max.	5			10	mA
$(dv/dt)_{cr}$	Critical Rate-of-rise of Off-stage Voltage	$T_{vj} = 125\text{ °C}$ , $V_D = V_{DRM}/V_{RRM}$ , Exp. Waveform, $R_{GK} = 1\text{ kΩ}$	Min.	75			200	V/μs
$t_q$	Turn-off Time	$T_{vj} = 25\text{ °C @ }600\text{ V}$ , $R_{GK} = 1\text{ kΩ}$	Max.	30	25	25	15	μs
$t_{gt}$	Turn-on Time	$I_G = 10\text{ mA}$ , $P_W = 15\text{ μs}$ , $I_T = 1.6\text{ A}_{pk}$	Typ.	2.0			4	μs

Note: x = voltage/100, y = package

### Static Characteristics ( $T_{vj} = 25\text{ }^{\circ}\text{C}$ , unless otherwise specified)

Symbol	Characteristics	Conditions	Maximum Value				Units
			SxX8yS1	SxX8yS2	SxX8yS	SxX8yS3	
$V_{TM}$	Peak On-state Voltage	$I_T = 35.4\text{ A } t_p = 380\text{ }\mu\text{s}$	1.7				V
$I_{DRM}$	Off-state Current, Peak Repetitive	$T_{vj} = 25\text{ }^{\circ}\text{C} @ V_D = V_{DRM}, R_{GK} = 1\text{ k}\Omega$	3				$\mu\text{A}$
		$T_{vj} = 125\text{ }^{\circ}\text{C} @ V_D = V_{DRM}, R_{GK} = 1\text{ k}\Omega$	500		100		

### Thermal Characteristics

Symbol	Characteristics	Conditions	Value	Units	
$R_{thJC}$	Thermal Resistance, Junction to Case (AC)	$I_T = 0.8\text{ A}_{(RMS)}$ <sup>1</sup>	TO-92	75	K/W
			SOT-223	30	
			SOT-89	50	
$R_{thJA}$	Thermal Resistance, Junction to Ambient	$I_T = 0.8\text{ A}_{(RMS)}$ <sup>1</sup>	TO-92	150	K/W
			SOT-223	60	
			SOT-89	90	

**Note 1:** 60 Hz AC resistive load condition, 100% conduction

**Characteristic Curves**

**Fig. 1. Normalized DC Gate Trigger Current for all Quadrants vs. Junction Temperature**

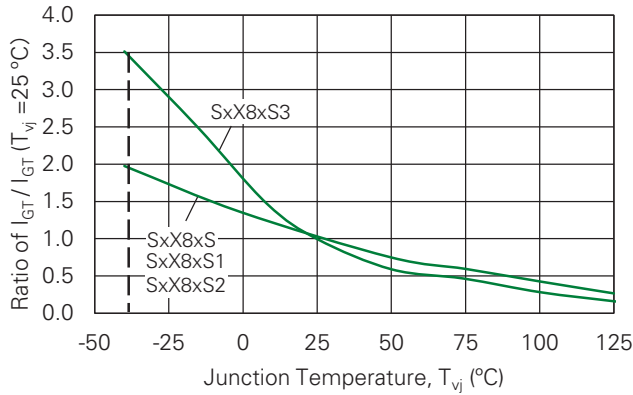

**Fig. 2. Normalized DC Holding Current vs. Junction Temperature**

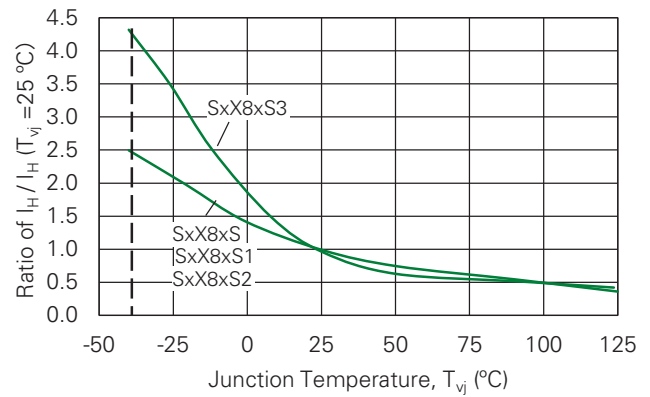

**Fig. 3. Normalized DC Gate Trigger Voltage vs. Junction Temperature**

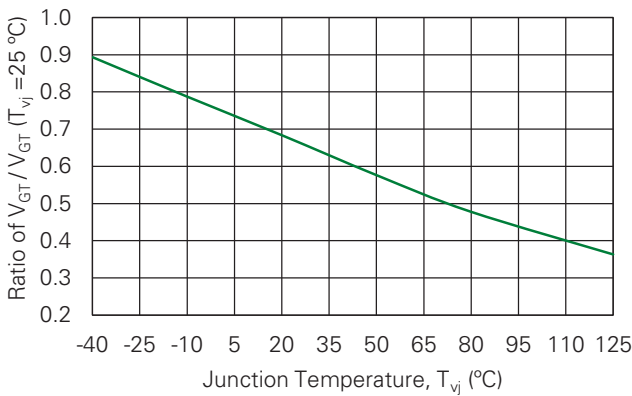

**Fig. 4. Typical On-state Current vs. On-state Voltage**

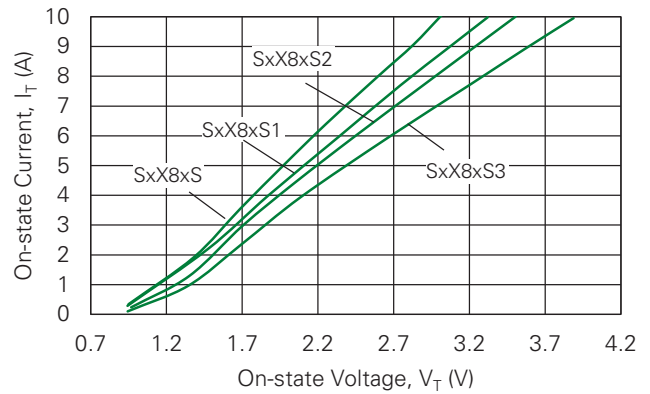

**Fig. 5. Typical Power Dissipation vs. RMS On-state Current**

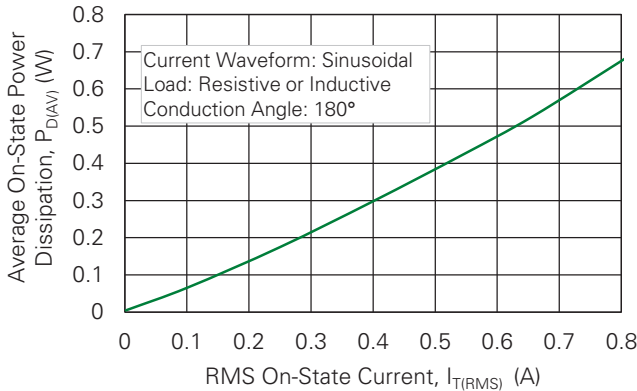

**Fig. 6. Maximum Allowable Case Temperature vs. On-state Current**

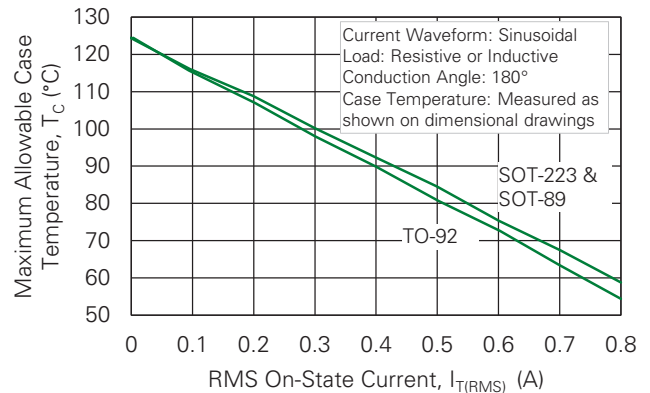

**Fig. 7-1. Typical DC Gate Trigger Current with  $R_{GK}$  vs. Junction Temperature for S6X8xS**

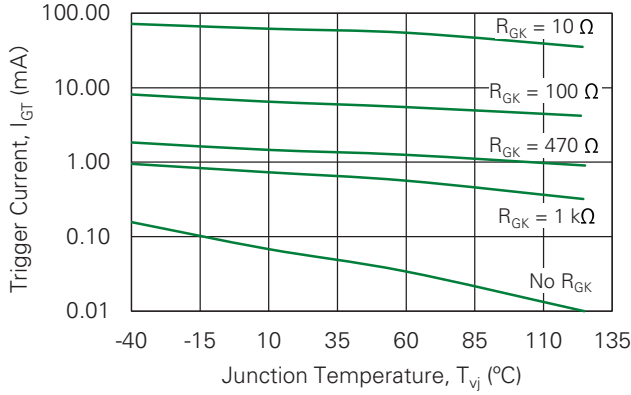

**Fig. 7-2. Typical DC Gate Trigger Current with  $R_{GK}$  vs. Junction Temperature for S8X8xS**

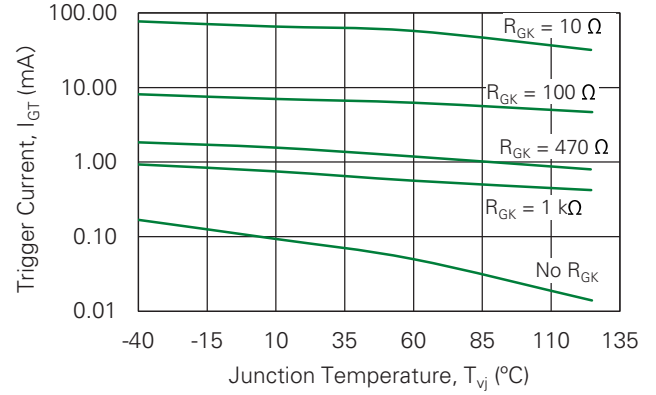

**Fig. 7-3. Typical DC Gate Trigger Current with  $R_{GK}$  vs. Junction Temperature for S6X8xS3**

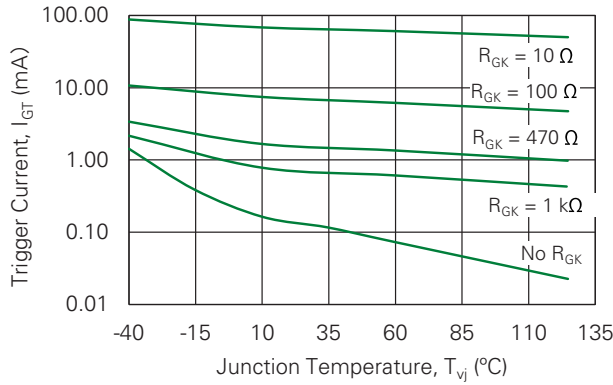

**Fig. 8-1. Typical DC Holding Current with  $R_{GK}$  vs. Junction Temperature for S6X8xS**

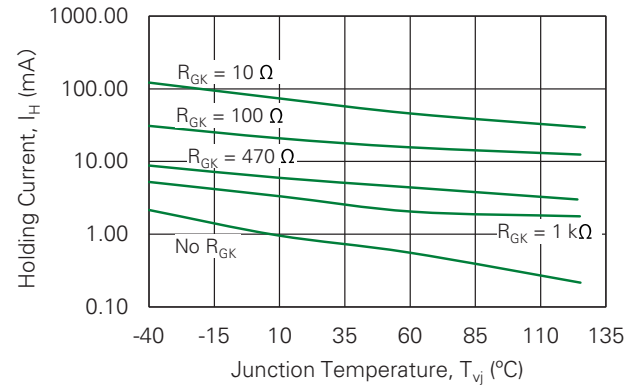

**Fig. 8-2. Typical DC Holding Current with  $R_{GK}$  vs. Junction Temperature for S8X8xS**

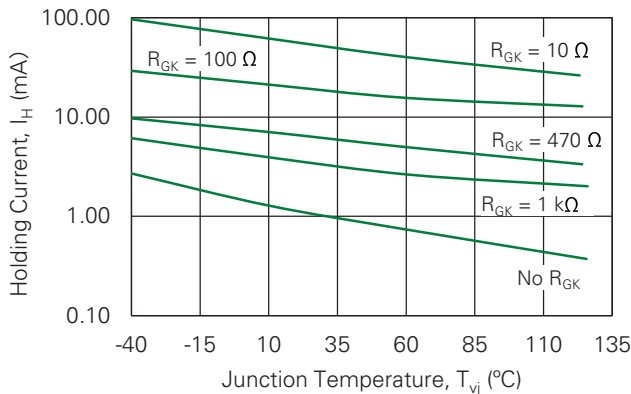

**Fig. 8-3. Typical DC Holding Current with  $R_{GK}$  vs. Junction Temperature for S6X8xS3**

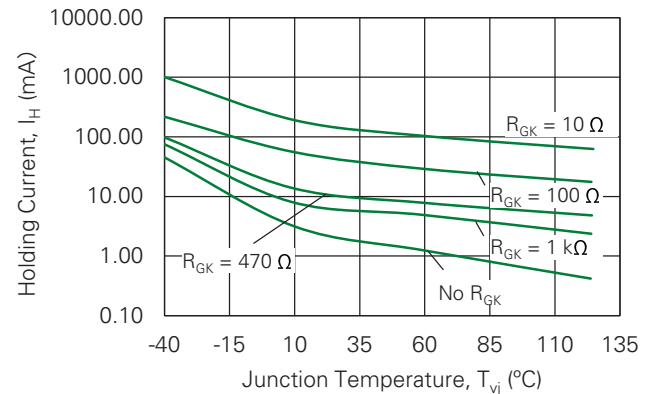

**Fig. 9-1. Typical DC Static dv/dt with  $R_{GK}$  vs. Junction Temperature for S6X8xS**

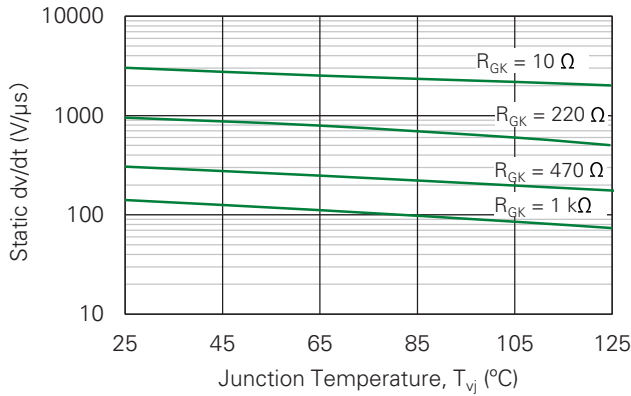

**Fig. 9-2. Typical DC Static dv/dt with  $R_{GK}$  vs. Junction Temperature for S8X8xS**

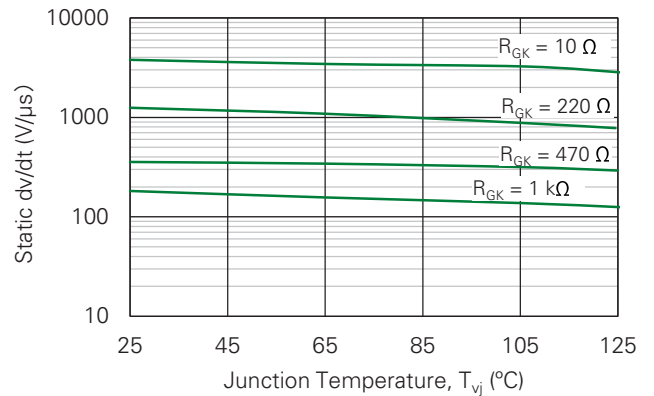

**Fig. 9-3. Typical DC Static dv/dt with  $R_{GK}$  vs. Junction Temperature for S6X8xS3**

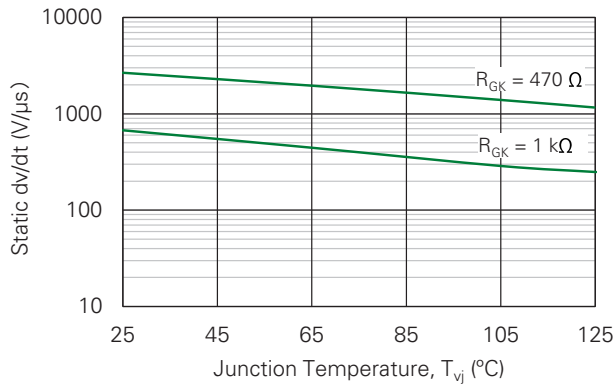

**Fig. 10-1. Typical DC Turn-off Time with  $R_{GK}$  vs. Junction Temperature for S6X8xS**

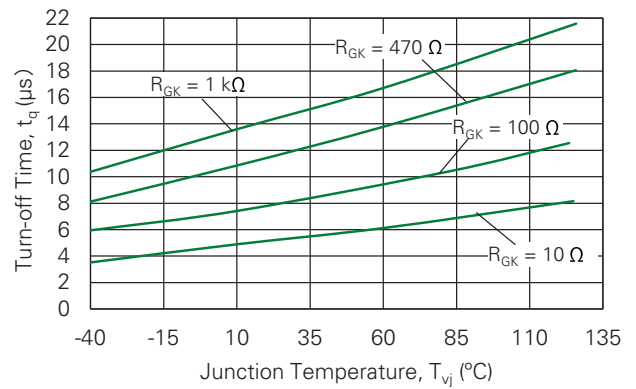

**Fig. 10-2. Typical DC Turn-off Time with  $R_{GK}$  vs. Junction Temperature for S8X8xS**

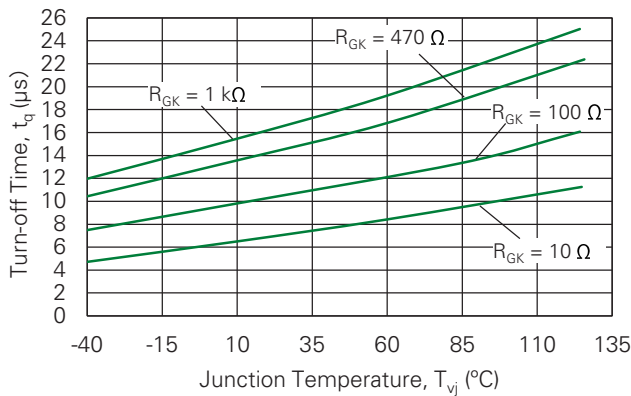

**Fig. 11. Surge Peak On-state Current vs. Number of Cycles**

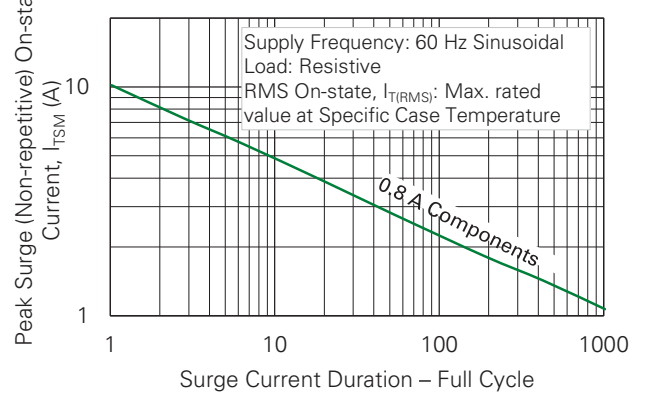

Notes:

1. Gate control may be lost during and immediately following surge current interval.
2. Overload may not be repeated until junction temperature has returned to steady-state rated value.

Fig. 12. Peak Repetitive Sinusoidal Pulse Current

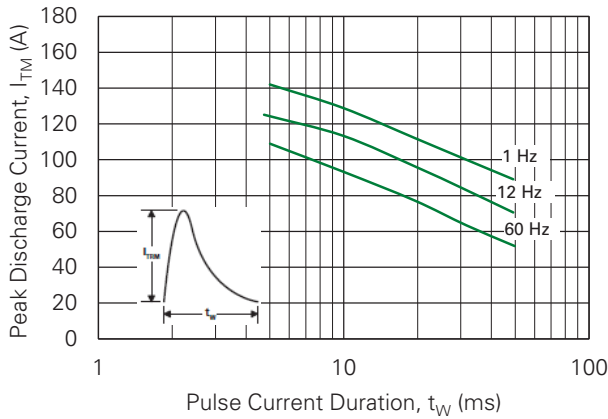

## Soldering Parameters

Characteristic		Value
Reflow Condition		Pb – Free assembly
Pre-heat	Temperature Min ( $T_{s(min)}$ )	150°C
	Temperature Max ( $T_{s(max)}$ )	200°C
	Time (min to max) ( $t_s$ )	60 – 180 secs
Average ramp up rate (Liquidus Temp)( $T_L$ ) to peak		5°C/second max
$T_{s(max)}$ to $T_L$ - Ramp-up Rate		5°C/second max
Reflow	Temperature ( $T_L$ ) (Liquidus)	217°C
	Time ( $t_L$ )	60 – 150 seconds
Peak Temperature ( $T_P$ )		260 <sup>+0/-5</sup> °C
Time within 5°C of actual peak Temperature ( $t_p$ )		20 – 40 seconds
Ramp-down Rate		5°C/second max
Time 25°C to peak Temperature ( $T_P$ )		8 minutes max
Do Not Exceed		280°C

## Design Considerations

Careful selection of the correct component for the application's operating parameters and environment will go a long way toward extending the operating life of the Thyristor. Good design practice should limit the maximum continuous current through the main terminals to 75% of the component rating. Other ways to ensure long life for a power discrete semiconductor are proper heat sinking and selection of voltage ratings for worst case conditions. Overheating, overvoltage (including  $dv/dt$ ), and surge currents are the main killers of semiconductors. Correct mounting, soldering, and forming of the leads also help protect against component damage.

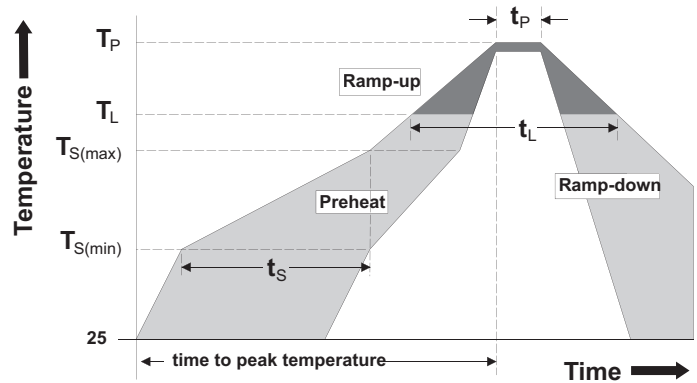

## Environmental Specifications

Test	Specifications and Conditions
AC Blocking	MIL-STD-750, M-1040, Cond A Applied Peak AC voltage @ 110 °C for 1008 hours
Temperature/Humidity	EIA / JEDEC, JESD22-A101, 1008 hours; 320 V - DC: 85 °C; 85 % relative humidity
Temperature Cycling	MIL-STD-750, M-1051, 100 cycles; -40 °C to +150 °C; 15-min dwell-time
High-temperature Storage	MIL-STD-750, M-1031, 1008 hours; 150 °C
Low-temperature Storage	1008 hours; -40 °C
Resistance to Solder Heat	MIL-STD-750: Method 2031
Solderability	ANSI/J-STD-002: category 3, Test A
Lead Bend	MIL-STD-750, M-2036 Cond E

## Physical Specifications

Characteristic	Value
Terminal Finish	100% Matte Tin-plated
Body Material	UL Recognized compound meeting flammability rating V-0
Lead Material	Copper Alloy

## Product Selector

Part Number	Voltage			Gate Sensitivity	Package
	400 V	600 V	800 V		
SxX8BS	X	X	–	200 µA	SOT-89
SxX8ES	X	X	X	200 µA	TO-92
SxX8TS	X	X	X	200 µA	SOT-223
SxX8BS1	X	X	–	5 µA	SOT-89
SxX8ES1	X	X	X	5 µA	TO-92
SxX8TS1	X	X	X	5 µA	SOT-223
SxX8BS2	X	X	–	50 µA	SOT-223
SxX8ES2	X	X	X	50 µA	SOT-89
SxX8TS2	X	X	X	50 µA	TO-92
SxX8TS3	–	X	–	450 µA	SOT-223

## Packing Options

Part Number	Marking	Weight	Packing Mode	Base Quantity
SxX8ESy	SxX8ESy	0.217 g	Bulk	2500
SxX8ESyAP	SxX8ESy	0.217 g	Ammo Pack	2000
SxX8ESyRP	SxX8ESy	0.217 g	Tape & Reel	2000
SxX8TSyRP	SxX8TSy	0.120 g	Tape & Reel	1000
SxX8BSyRP	xX8y	0.053 g	Tape & Reel	1000
SxX8BSyRP1	xX8y	0.053 g	Tape & Reel	1000

Note: x = voltage/100, y = gate sensitivity

## Part Numbering and Marking

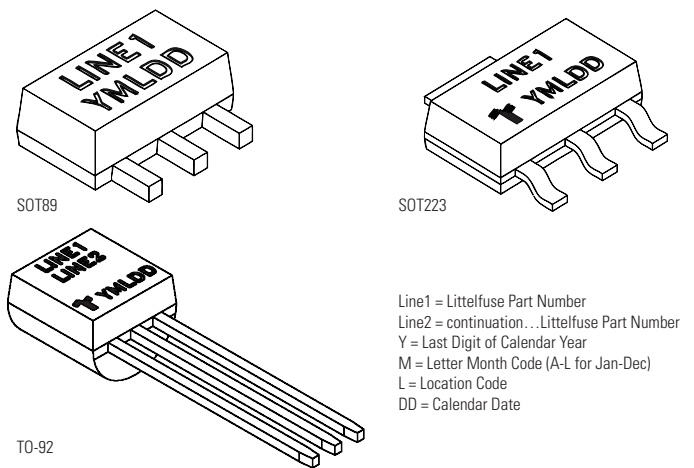
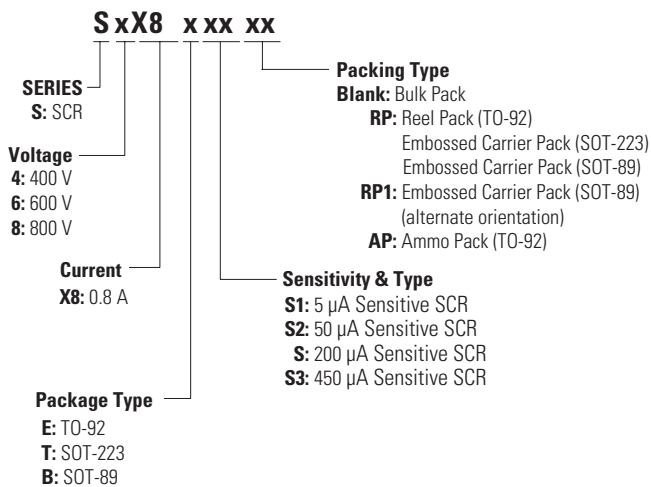



**Package Dimensions** TO-92

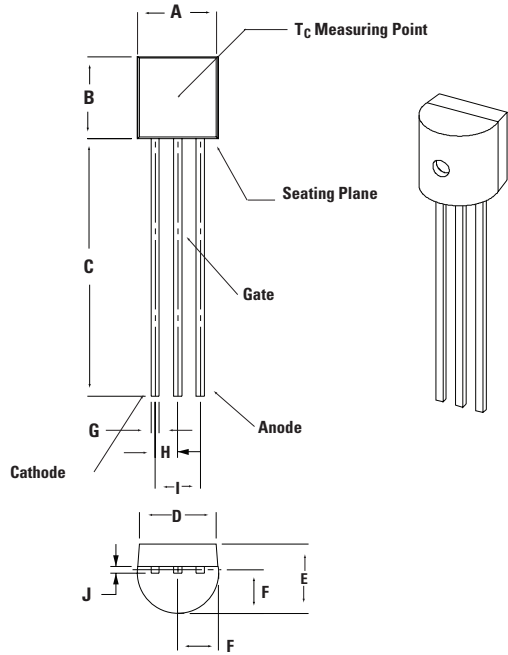

Symbol	Millimeters		Inches	
	Min.	Max.	Min.	Max
A	4.450	5.200	0.175	0.205
B	4.320	5.330	0.170	0.210
C	12.70	–	0.500	–
D	3.430	–	0.135	–
E	3.180	4.190	0.125	0.165
F	2.040	2.660	0.080	0.105
G	0.407	0.533	0.016	0.021
H	1.150	1.390	0.045	0.055
I	2.420	2.660	0.095	0.105
J	0.380	0.500	0.015	0.020

**Package Dimensions** SOT-223

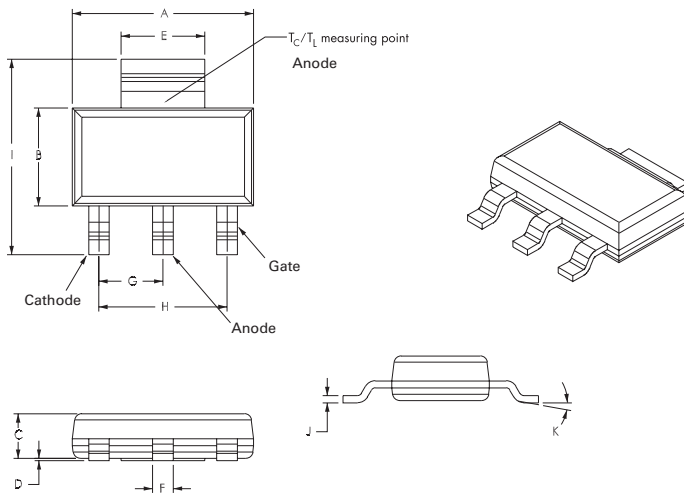

Symbol	Millimeters			Inches		
	Min.	Typ.	Max.	Min.	Typ.	Max
A	0.248	0.256	0.264	0.248	0.256	0.264
B	0.130	0.138	0.146	0.130	0.138	0.146
C	–	–	0.071	–	–	0.071
D	0.001	–	0.005	0.02	–	0.13
E	0.114	0.118	0.124	2.90	3.00	3.15
F	0.024	0.027	0.034	0.60	0.70	0.85
G	–	0.090	–	–	2.30	–
H	–	0.181	–	–	4.60	–
I	0.264	0.276	0.287	6.70	7.00	7.30
J	0.009	0.010	0.014	0.23	0.26	0.35
K	10° MAX.					

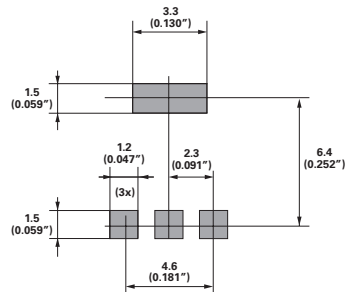

Dimensions in Millimeters (Inches)

**Package Dimensions** SOT-89

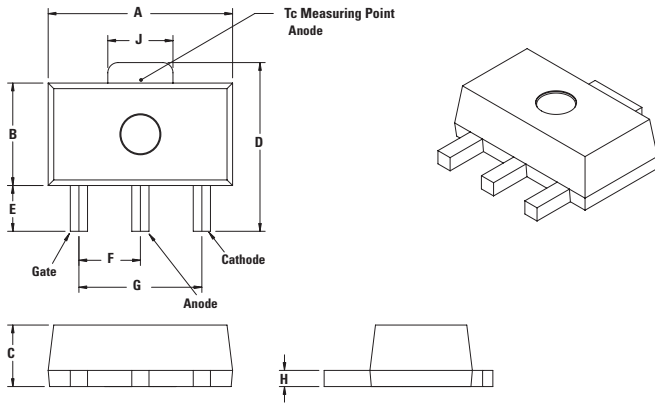

Symbol	Millimeters			Inches		
	Min.	Typ.	Max.	Min.	Typ.	Max
A	4.40	–	4.60	0.173	–	0.181
B	2.29	–	2.60	0.090	–	0.102
C	1.40	–	1.60	0.055	–	0.063
D	3.94	–	4.25	0.155	–	0.167
E	0.89	–	1.20	0.035	–	0.047
F	1.42	–	1.57	0.056	–	0.062
G	2.92	–	3.07	0.115	–	0.121
H	0.35	–	0.44	0.014	–	0.017
I	0.36	–	0.48	0.014	–	0.019
J	1.62	1.69	1.83	0.064	0.067	0.072

Pad Layout for SOT-89

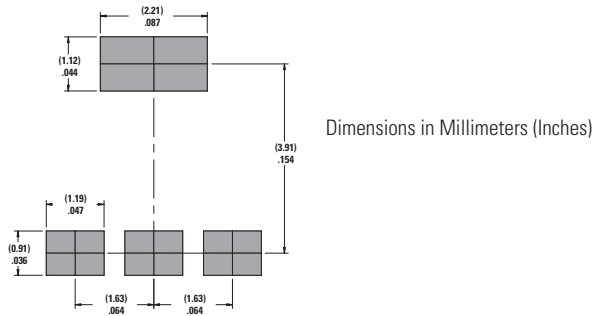

**TO-92 (3-lead) Reel Pack (RP) Radial Leaded Specifications**

Meets all EIA-468-C Standards

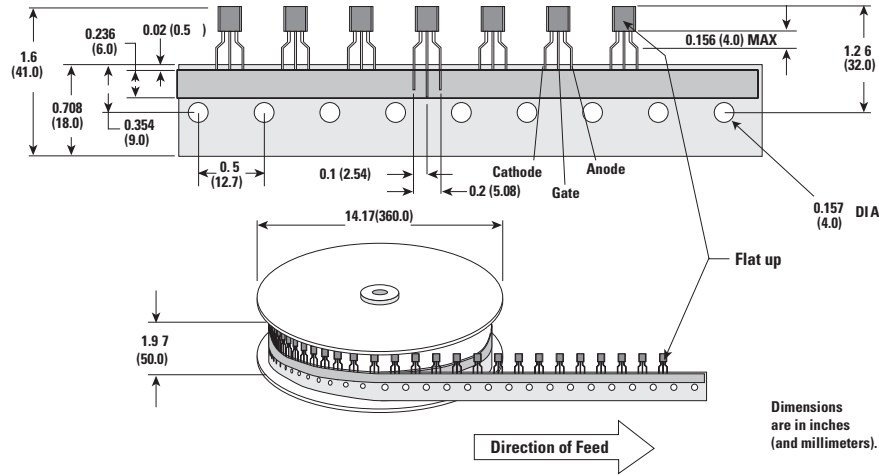

### TO-92 (3-lead) Ammo Pack (AP) Radial Leaded Specifications

Meets all EIA-468-C Standards

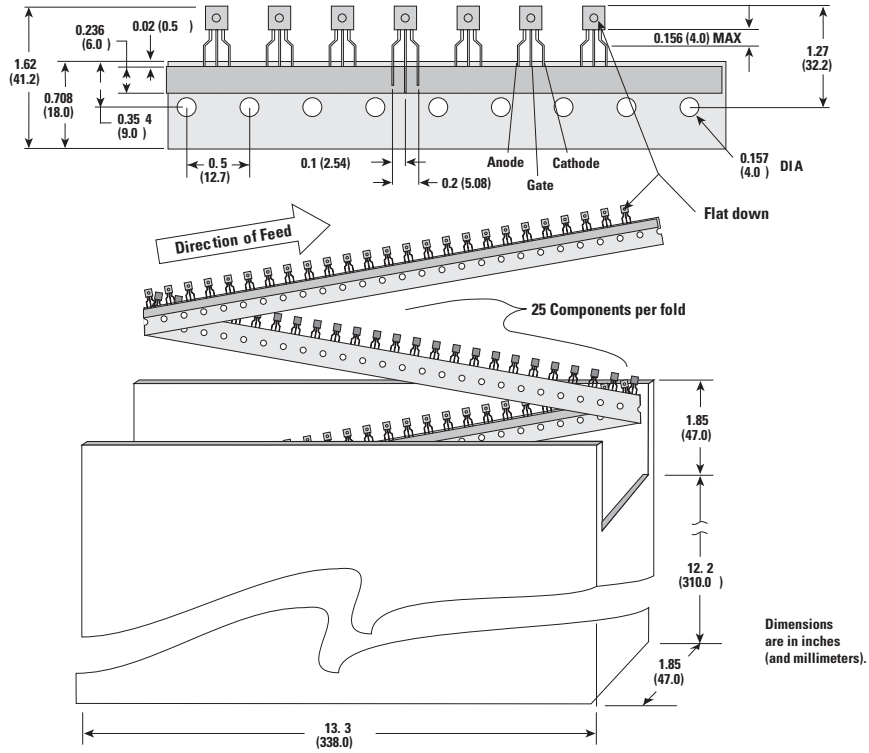

### SOT-89 Reel Pack (RP) Specifications

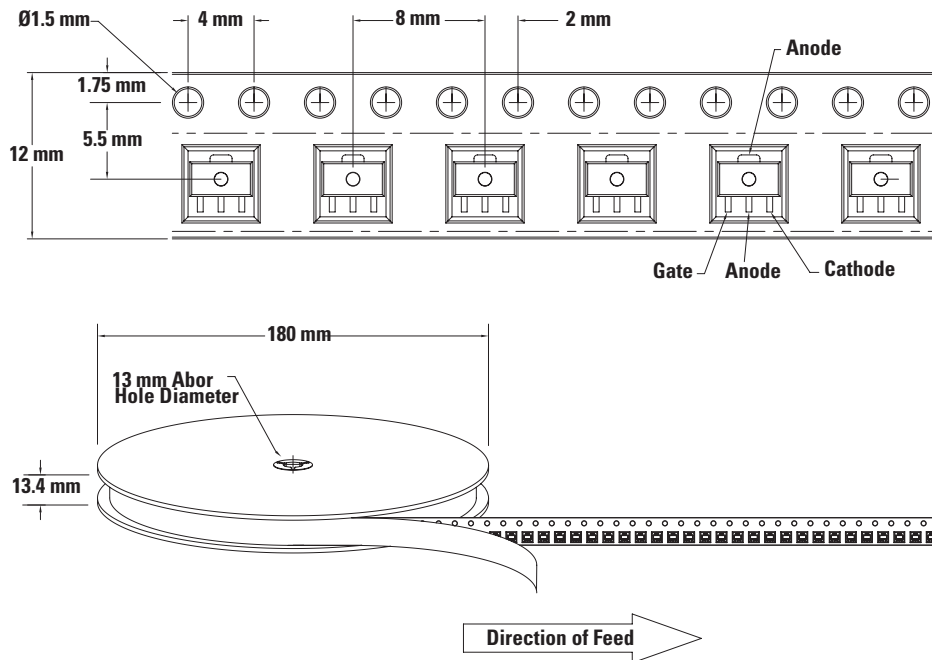

### SOT-89 Reel Pack (RP1) Specifications

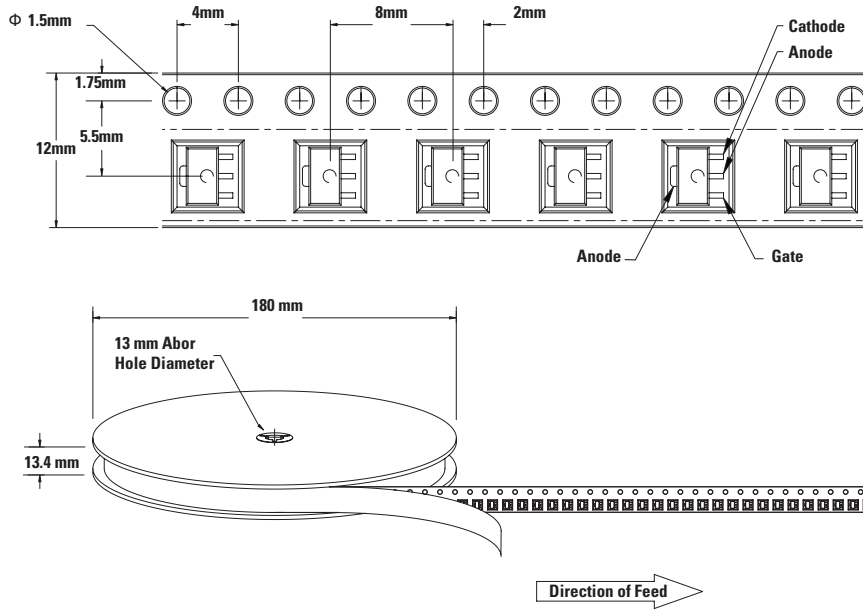

### SOT-223 Reel Pack (RP) Specifications

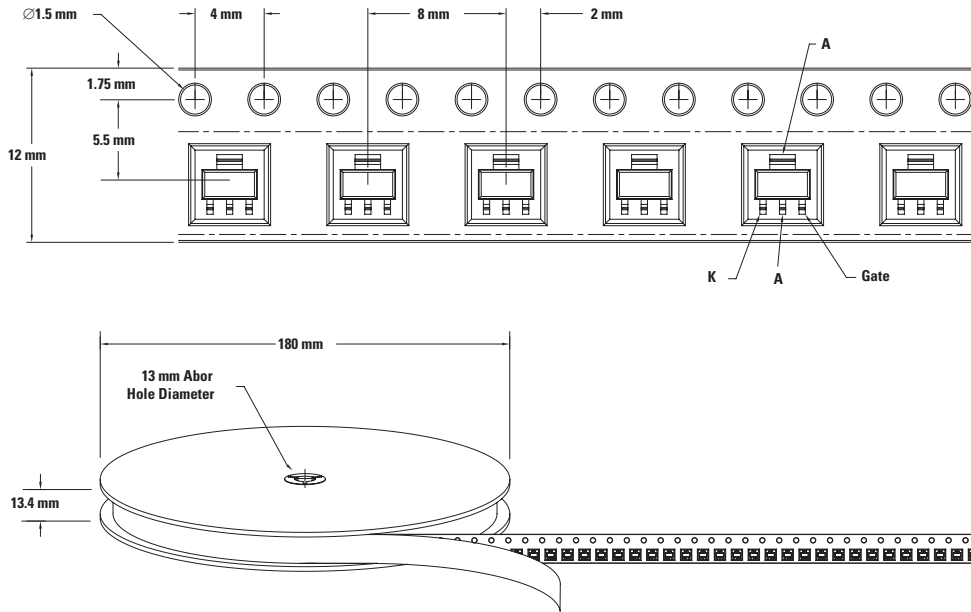

**Disclaimer Notice**

Information furnished is believed to be accurate and reliable. However, users should independently evaluate the suitability of and test each product selected for their own applications. Littelfuse products are not designed for, and may not be used in, all applications. Read complete Disclaimer Notice at <http://www.littelfuse.com/disclaimer-electronics>.



Part of:

