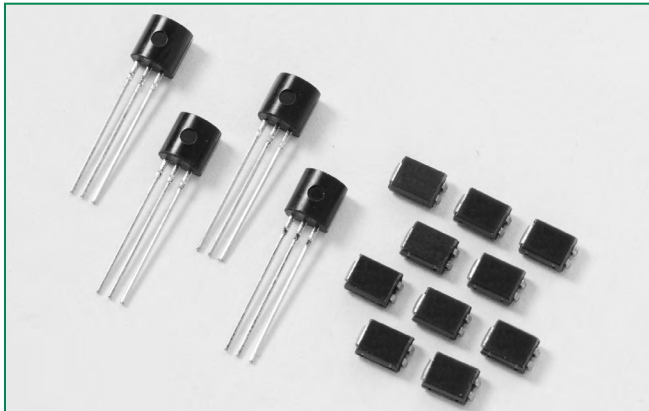


### Sx01E & SxN1 Series

RoHS



#### Description

Excellent for lower current heat, lamp, and audible alarm controls for home goods.

Standard phase control SCRs are triggered with few milliamperes of current at less than 1.5V potential.

#### Features & Benefits

- RoHS compliant
- Glass – passivated junctions
- Voltage capability up to 600 V
- Surge capability up to 30 A

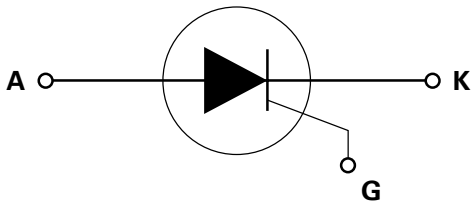
#### Applications

Typical applications are AC solid-state switches, fluidlevel sensors, strobes, and capacitive-discharge ignition systems.

#### Main Features

Symbol	Value	Unit
$I_{T(RMS)}$	1	A
$V_{DRM}/V_{RRM}$	400 to 600	V
$I_{GT}$	10	mA

#### Schematic Symbol



#### Additional Information



Datasheet



Resources



Samples

#### Absolute Maximum Ratings – Standard SCRs

Symbol	Parameter	Test Conditions	Value	Unit
$I_{T(RMS)}$	RMS on-state current	$T_c = 90^\circ\text{C}$	1	A
$I_{T(AV)}$	Average on-state current	$T_c = 90^\circ\text{C}$	0.64	A
$I_{TSM}$	Peak non-repetitive surge current	single half cycle; $f = 50\text{Hz}$ ; $T_j$ (initial) = $25^\circ\text{C}$	25	A
		single half cycle; $f = 60\text{Hz}$ ; $T_j$ (initial) = $25^\circ\text{C}$	30	
$I^2t$	$I_2t$ Value for fusing	$t_p = 8.3\text{ ms}$	3.7	$\text{A}^2\text{s}$
$di/dt$	Critical rate of rise of on-state current	$f = 60\text{Hz}$ ; $T_j = 125^\circ\text{C}$	50	$\text{A}/\mu\text{s}$
$I_{GM}$	Peak gate current	$T_j = 125^\circ\text{C}$	1.5	A
$P_{G(AV)}$	Average gate power dissipation	$T_j = 125^\circ\text{C}$	0.3	W
$T_{stg}$	Storage temperature range		-40 to 150	$^\circ\text{C}$
$T_j$	Operating junction temperature range		-40 to 125	$^\circ\text{C}$

**Electrical Characteristics (T<sub>J</sub> = 25°C, unless otherwise specified)**

Symbol	Test Conditions		Value	Unit
I <sub>GT</sub>	V <sub>D</sub> = 12V; R <sub>L</sub> = 60 Ω	MAX.	10	mA
		MIN.	1	
V <sub>GT</sub>	V <sub>D</sub> = 12V; R <sub>L</sub> = 60 Ω	MAX.	1.5	V
dv/dt	V <sub>D</sub> = V <sub>DRM</sub> ; gate open; T <sub>J</sub> = 100°C	MIN.	20	V/μs
	V <sub>D</sub> = V <sub>DRM</sub> ; gate open; T <sub>J</sub> = 125°C		40	
V <sub>GD</sub>	V <sub>D</sub> = V <sub>DRM</sub> ; R <sub>L</sub> = 3.3 kΩ; T <sub>J</sub> = 125°C	MIN.	0.2	V
I <sub>H</sub>	I <sub>T</sub> = 200mA (initial)	MAX.	30	mA
t <sub>q</sub>	(1)	MAX.	35	μs
t <sub>gt</sub>	I <sub>G</sub> = 2 × I <sub>GT</sub> ; PW = 15μs; I <sub>T</sub> = 2A	TYP.	2	μs

(1) I<sub>T</sub>=1A; t<sub>q</sub>=50μs; dv/dt=20V/μs; di/dt=-10A/μs

**Static Characteristics**

Symbol	Test Conditions		Value	Unit
V <sub>TM</sub>	I <sub>T</sub> = 2A; t <sub>p</sub> = 380 μs	MAX.	1.6	V
I <sub>DRM</sub> / I <sub>RRM</sub>	V <sub>DRM</sub> = V <sub>RRM</sub>	T <sub>J</sub> = 25°C	10	μA
		T <sub>J</sub> = 100°C	200	
		T <sub>J</sub> = 125°C	500	

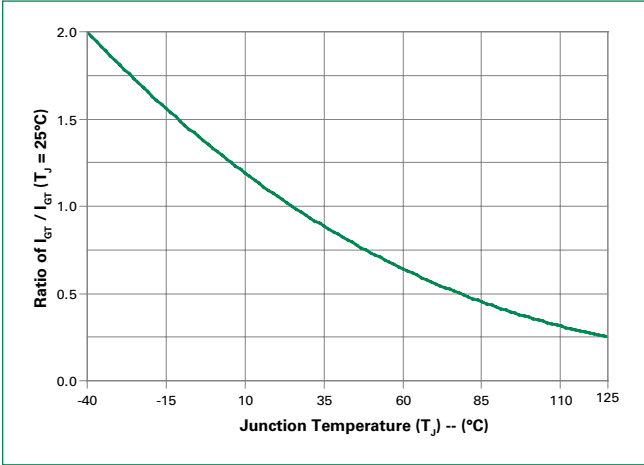
**Thermal Resistances**

Symbol	Parameter		Value	Unit
R <sub>θ(J-C)</sub>	Junction to case (AC)	Sx01E	50	°C/W
		SxN1	35*	
R <sub>θ(J-A)</sub>	Junction to ambient	Sx01E	145	°C/W

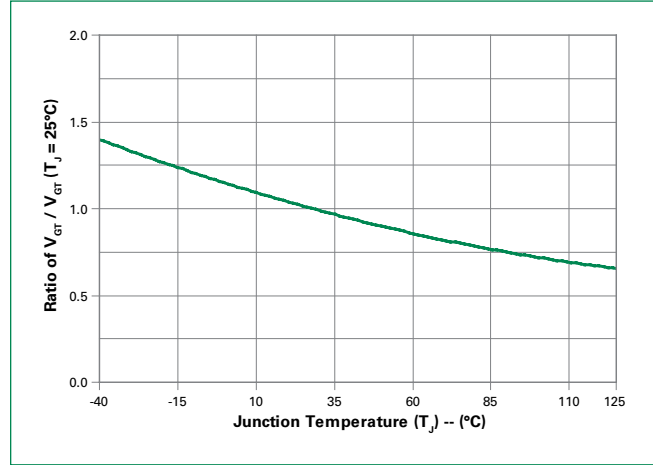
Notes : x = voltage

\* = Mounted on 1 cm<sup>2</sup> copper (two-ounce) foil surface

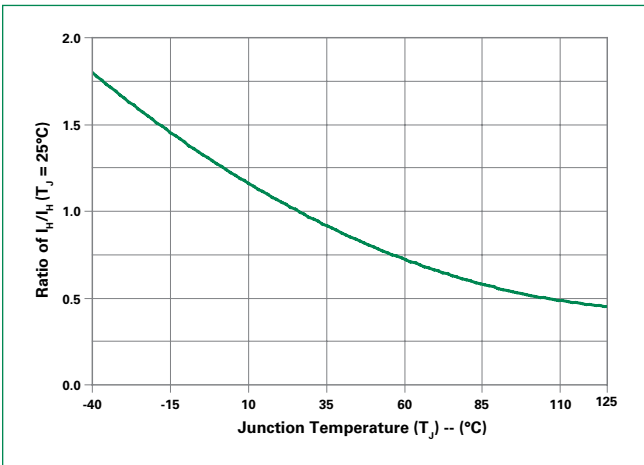
**Figure 1: Normalized DC Gate Trigger Current vs. Junction Temperature**



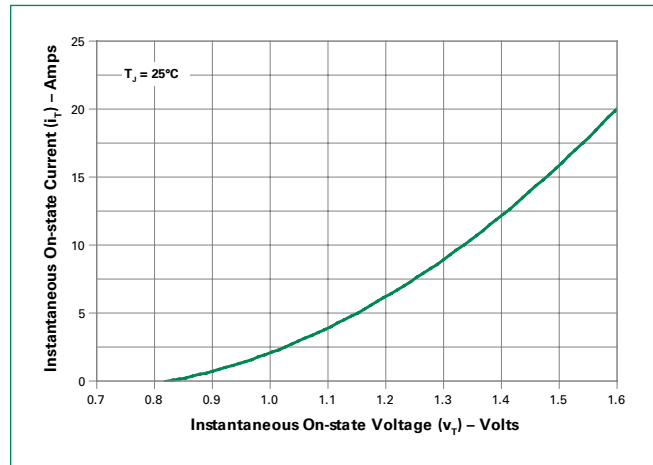
**Figure 2: Normalized DC Gate Trigger Voltage vs. Junction Temperature**



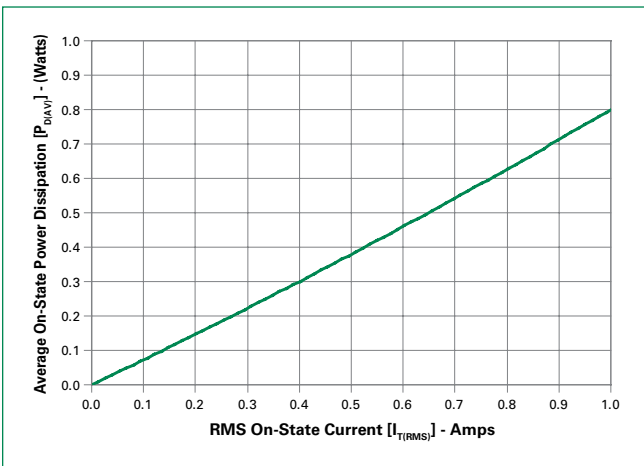
**Figure 3: Normalized DC Holding Current vs. Junction Temperature**



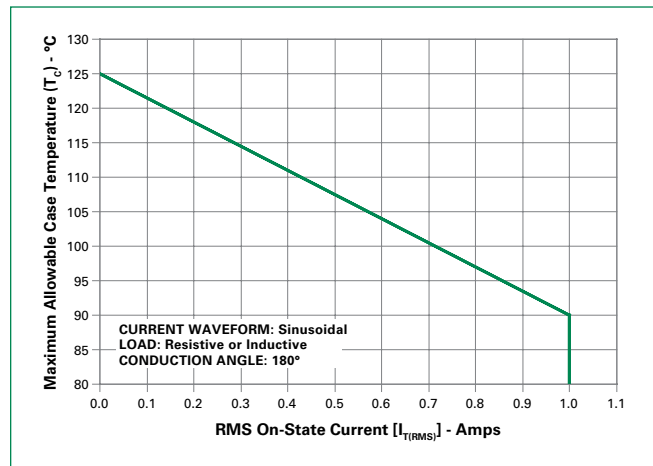
**Figure 4: On-State Current vs. On-State Voltage (Typical)**



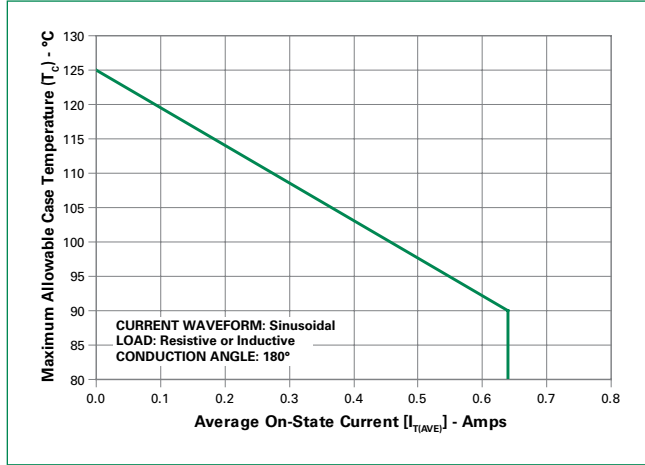
**Figure 5: Power Dissipation (Typical) vs. RMS On-State Current**



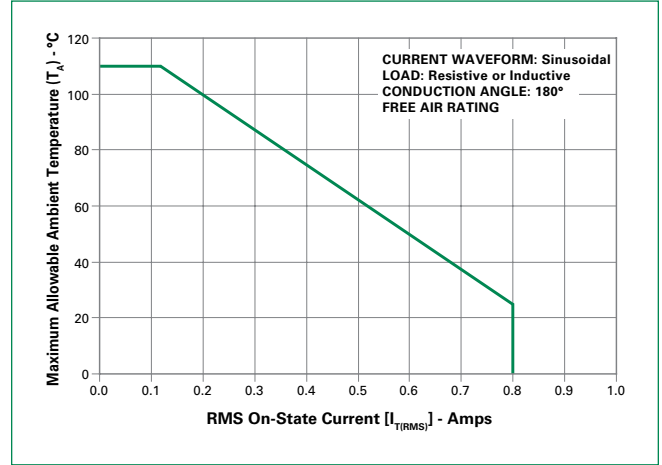
**Figure 6: Maximum Allowable Case Temperature vs. RMS On-State Current**



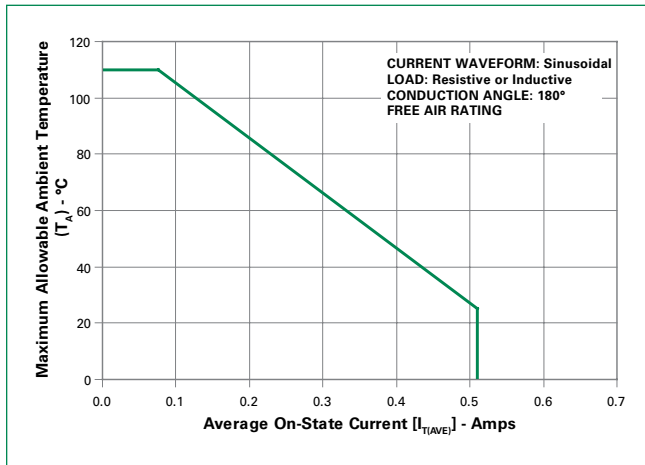
**Figure 7: Maximum Allowable Case Temperature vs. Average On-State Current**



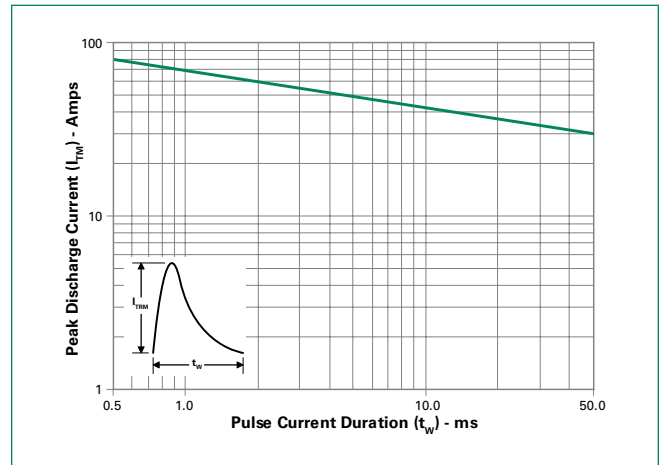
**Figure 8: Maximum Allowable Ambient Temperature vs. RMS On-State Current**



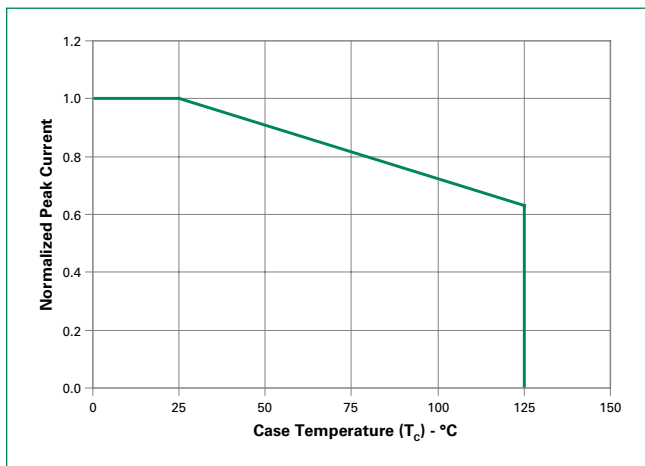
**Figure 9: Maximum Allowable Ambient Temperature vs. Average On-State Current**



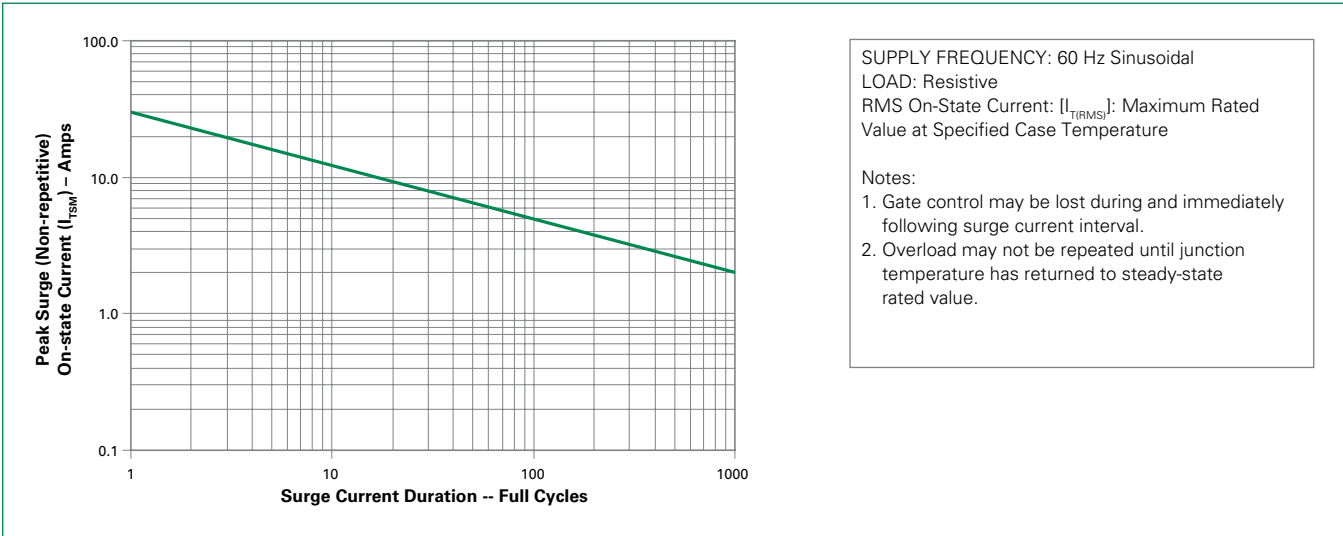
**Figure 10: Peak Capacitor Discharge Current**



**Figure 11: Peak Capacitor Discharge Current Derating**

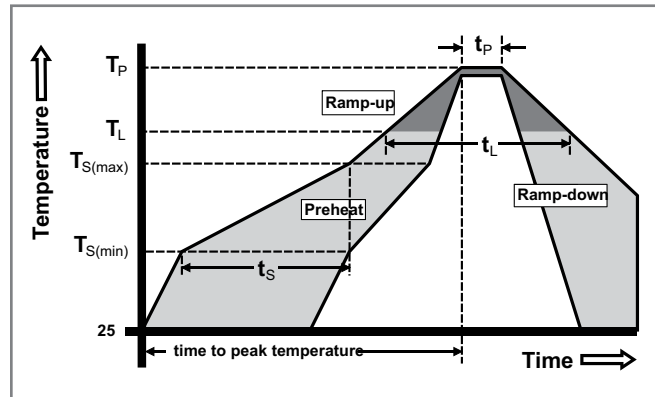


**Figure 12: Surge Peak On-State Current vs. Number of Cycles**



**Soldering Parameters**

Reflow Condition		Pb – Free assembly
Pre Heat	- Temperature Min ( $T_{s(min)}$ )	150°C
	- Temperature Max ( $T_{s(max)}$ )	200°C
	- Time (min to max) ( $t_s$ )	60 – 180 secs
Average ramp up rate (Liquidus Temp ( $T_L$ ) to peak)		5°C/second max
$T_{s(max)}$ to $T_L$ - Ramp-up Rate		5°C/second max
Reflow	- Temperature ( $T_L$ ) (Liquidus)	217°C
	- Temperature ( $t_L$ )	60 – 150 seconds
Peak Temperature ( $T_p$ )		260 <sup>+0/-5</sup> °C
Time within 5°C of actual peak Temperature ( $t_p$ )		20 – 40 seconds
Ramp-down Rate		5°C/second max
Time 25°C to peak Temperature ( $T_p$ )		8 minutes Max.
Do not exceed		280°C



### Physical Specifications

<b>Terminal Finish</b>	100% Matte Tin-plated
<b>Body Material</b>	UL recognized epoxy meeting flammability classification 94V-0
<b>Lead Material</b>	Copper Alloy

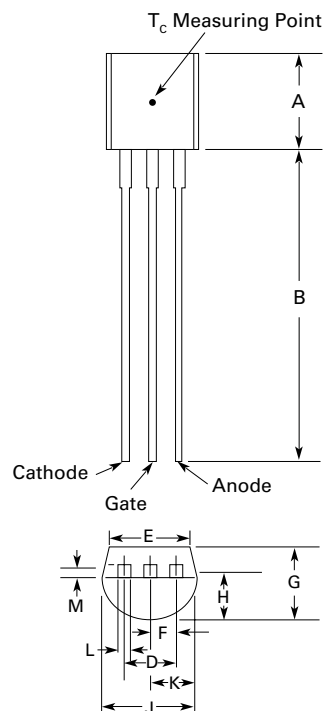
### Design Considerations

Careful selection of the correct device for the application's operating parameters and environment will go a long way toward extending the operating life of the Thyristor. Good design practice should limit the maximum continuous current through the main terminals to 75% of the device rating. Other ways to ensure long life for a power discrete semiconductor are proper heat sinking and selection of voltage ratings for worst case conditions. Overheating, overvoltage (including dv/dt), and surge currents are the main killers of semiconductors. Correct mounting, soldering, and forming of the leads also help protect against component damage.

### Environmental Specifications

Test	Specifications and Conditions
<b>AC Blocking</b>	MIL-STD-750, M-1040, Cond A Applied Peak AC voltage @ 125°C for 1008 hours
<b>Temperature Cycling</b>	MIL-STD-750, M-1051, 100 cycles; -40°C to +150°C; 15-min dwell-time
<b>Temperature/Humidity</b>	EIA / JEDEC, JESD22-A101 1008 hours; 320V - DC: 85°C; 85% rel humidity
<b>High Temp Storage</b>	MIL-STD-750, M-1031, 1008 hours; 150°C
<b>Low-Temp Storage</b>	1008 hours; -40°C
<b>Resistance to Solder Heat</b>	MIL-STD-750 Method 2031
<b>Solderability</b>	ANSI/J-STD-002, category 3, Test A
<b>Lead Bend</b>	MIL-STD-750, M-2036 Cond E

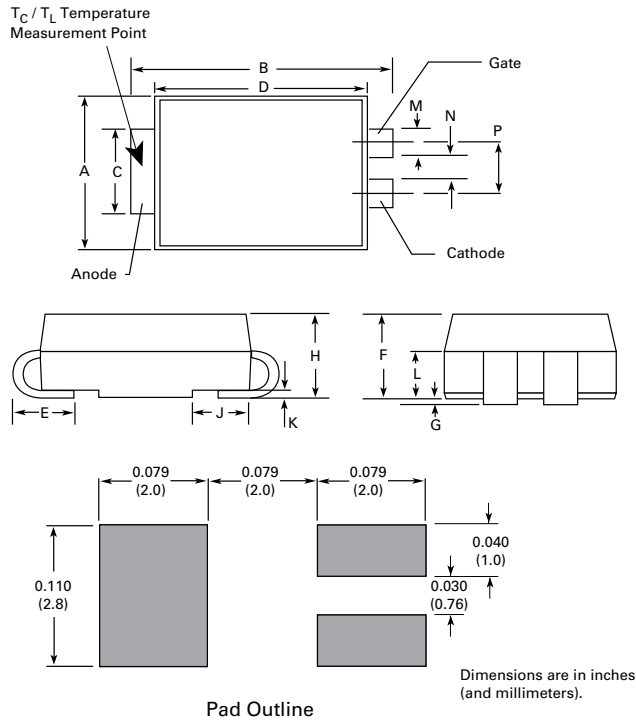
### Dimensions – TO-92 (E Package)



Dimension	Inches		Millimeters	
	Min	Max	Min	Max
A	0.176	0.196	4.47	4.98
B	0.500		12.70	
D	0.095	0.105	2.41	2.67
E	0.150		3.81	
F	0.046	0.054	1.16	1.37
G	0.135	0.145	3.43	3.68
H	0.088	0.096	2.23	2.44
J	0.176	0.186	4.47	4.73
K	0.088	0.096	2.23	2.44
L	0.013	0.019	0.33	0.48
M	0.013	0.017	0.33	0.43

All leads insulated from case. Case is electrically nonconductive.

**Dimensions - Compak (C Package)**



Dimension	Inches		Millimeters	
	Min	Max	Min	Max
A	0.130	0.156	3.30	3.95
B	0.201	0.220	5.10	5.60
C	0.077	0.087	1.95	2.20
D	0.159	0.181	4.05	4.60
E	0.030	0.063	0.75	1.60
F	0.075	0.096	1.90	2.45
G	0.002	0.008	0.05	0.20
H	0.077	0.104	1.95	2.65
J	0.043	0.053	1.09	1.35
K	0.006	0.016	0.15	0.41
L	0.030	0.055	0.76	1.40
M	0.022	0.028	0.56	0.71
N	0.027	0.033	0.69	0.84
P	0.052	0.058	1.32	1.47

**Product Selector**

Part Number	Voltage				Gate Sensitivity	Type	Package
	400V	600V	800V	1000V			
Sx01E	X	X			10mA	Standard SCR	TO-92
SxN1	X	X			10mA	Standard SCR	Compak

Note: x = Voltage

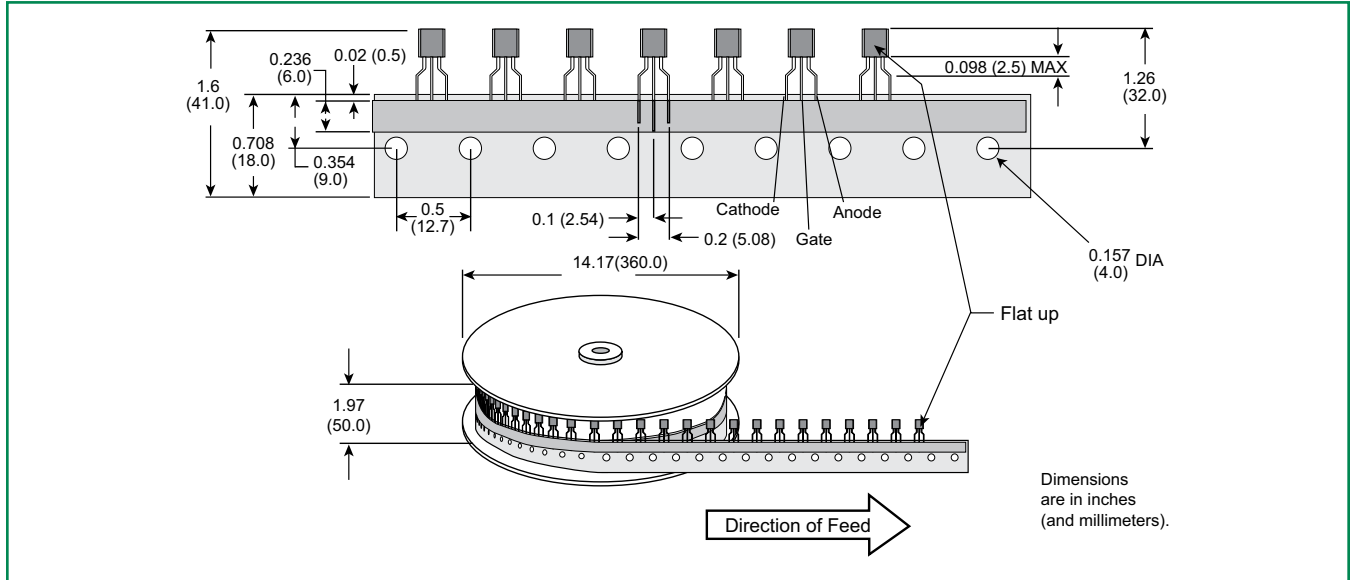
**Packing Options**

Part Number	Marking	Weight	Packing Mode	Base Quantity
Sx01E	Sx01E	0.19 g	Bulk	2000
Sx01ERP	Sx01E	0.19 g	Reel Pack	2000
Sx01EAP	Sx01E	0.19 g	Ammo Pack	2000
SxN1RP	SxN1	0.08 g	Embossed Carrier	2500

Note: x = Voltage

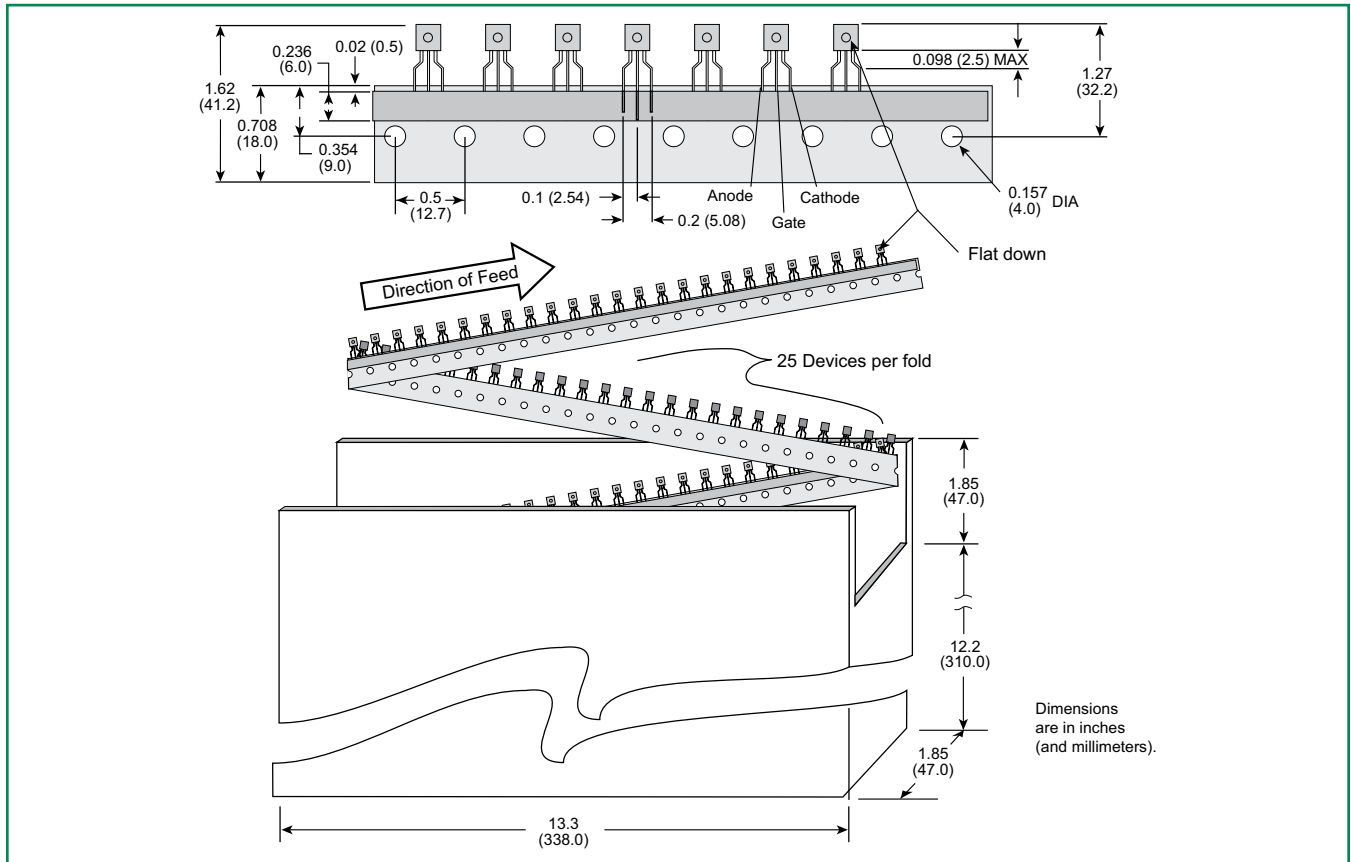
**TO-92 (3-lead) Reel Pack (RP) Radial Leaded Specifications**

Meets all EIA-468-C Standards



**TO-92 (3-lead) Ammo Pack (AP) Radial Leaded Specifications**

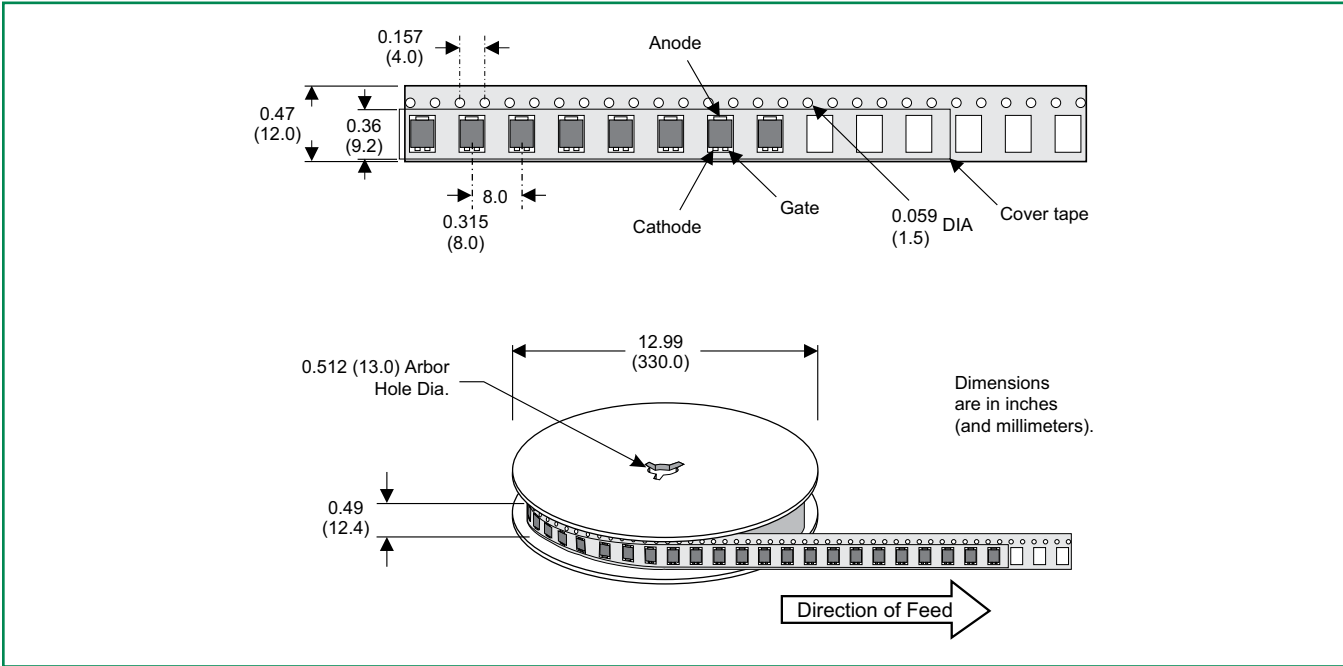
Meets all EIA-468-C Standards



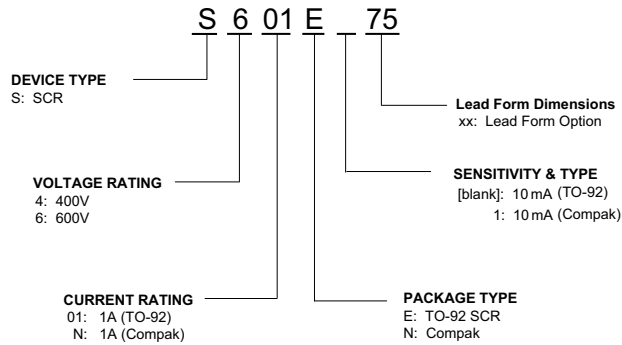


**Compak Embossed Carrier Reel Pack (RP) Specifications**

Meets all EIA-481-1 Standards

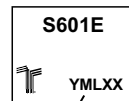


**Part Numbering System**



**Part Marking System**

**TO-92 (E Package)**



Date Code Marking  
Y: Year Code  
M: Month Code  
L: Location Code  
XX: Lot Serial Code

**Compak (C Package)**



Date Code Marking  
Y: Year Code  
M: Month Code  
XXX: Lot Trace Code