

**SJxx04xSx Series**



**Description**

This SJxx04x high temperature SCR series is ideal for uni-directional switch applications such as phase control in heating, motor speed controls, converters/rectifiers and capacitive discharge ignitions

These SCRs have a low gate current trigger level of 20µA maximum at approximately 1.5V.

**Features & Benefits**

- Voltage capability up to 600V
- Surge capability up to 100A at 60Hz half cycle
- 150°C maximum junction temperature
- Halogen free and RoHS compliant

**Main Features**

Symbol	Value	Unit
$I_{T(RMS)}$	4	A
$V_{DRM}/V_{RRM}$	400 or 600	V
$I_{GT}$	0.2	mA

**Schematic Symbol**

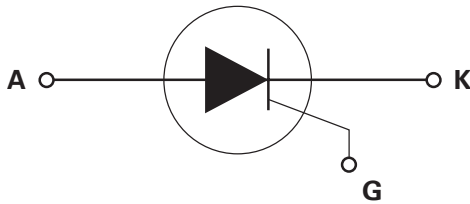

**Applications**

Typical applications includes capacitive discharge system for motorcycle engine CDI, portable generator engine ignition, strobe lights and nailers, as well as generic rectifiers, battery voltage regulators and converters. Also controls for power tools, home/brown goods and white goods appliances.

**Absolute Maximum Ratings – Sensitive SCRs**

Symbol	Parameter	Test Conditions	Value	Unit
$I_{T(RMS)}$	RMS on-state current	$T_c = 130^\circ\text{C}$	4	A
$I_{T(AV)}$	Average on-state current	$T_c = 130^\circ\text{C}$	2.56	A
$I_{TSM}$	Peak non-repetitive surge current	single half cycle; $f = 50\text{ Hz}$ ; $T_j(\text{initial}) = 25^\circ\text{C}$	25	A
		single half cycle; $f = 60\text{ Hz}$ ; $T_j(\text{initial}) = 25^\circ\text{C}$	30	
$I^2t$	$I^2t$ Value for fusing	$t_p = 8.3\text{ ms}$	3.7	$\text{A}^2\text{s}$
$di/dt$	Critical rate of rise of on-state current	$f = 60\text{ Hz}$ , $T_j = 150^\circ\text{C}$	50	$\text{A}/\mu\text{s}$
$I_{GM}$	Peak gate current	$Pw=20\ \mu\text{s}$ , $T_j = 150^\circ\text{C}$	0.5	A
$P_{G(AV)}$	Average gate power dissipation	$T_j = 150^\circ\text{C}$	0.1	W
$T_{stg}$	Storage temperature range		-40 to 150	$^\circ\text{C}$
$T_j$	Operating junction temperature range		-40 to 150	$^\circ\text{C}$
$V_{DSM}/V_{RSM}$	Peak non-repetitive blocking voltage	$Pw=100\ \mu\text{s}$	$V_{DRM}/V_{RRM} + 100$	V

**Electrical Characteristics ( $T_J = 25^\circ\text{C}$ , unless otherwise specified) – Sensitive SCRs**

Symbol	Test Conditions		Value	Unit
$I_{GT}$	$V_D = 6V$ $R_L = 100\ \Omega$	MIN.	20	$\mu\text{A}$
		MAX.	200	$\mu\text{A}$
$V_{GT}$		MAX.	0.8	V
dv/dt	$V_D = V_{DRM}$ ; $R_{GK} = 220\ \Omega$ ; $T_J = 125^\circ\text{C}$	MIN.	45	V/ $\mu\text{s}$
$V_{GD}$	$V_D = V_{DRM}$ ; $R_L = 3.3\ \text{k}\Omega$ ; $T_J = 125^\circ\text{C}$	MIN.	0.2	V
	$V_D = V_{DRM}$ ; $R_L = 3.3\ \text{k}\Omega$ ; $T_J = 150^\circ\text{C}$	MIN.	0.1	V
$V_{GRM}$	$I_{GR} = 10\ \mu\text{A}$	MIN.	6	V
$I_H$	$I_T = 20\text{mA}$ (initial)	MAX.	6	mA
$t_q$	$t_p = 50\ \mu\text{s}$ ; $dv/dt = 5\text{V}/\mu\text{s}$ ; $di/dt = -30\text{A}/\mu\text{s}$	MAX.	60	$\mu\text{s}$
$t_{gt}$	$I_G = 2 \times I_{GT}$ ; $PW = 15\ \mu\text{s}$ ; $I_T = 8\text{A}$	TYP.	3	$\mu\text{s}$

**Static Characteristics**

Symbol	Test Conditions		Value	Unit
$V_{TM}$	$I_T = 8\text{A}$ ; $t_p = 380\ \mu\text{s}$		MAX.	1.6
$I_{DRM} / I_{RRM}$	@ $V_{DRM} / V_{RRM}$	$T_J = 25^\circ\text{C}$	400 - 600V	5
		$T_J = 125^\circ\text{C}$ , $R_{GK} = 220\ \Omega$	400 - 600V	1000
		$T_J = 150^\circ\text{C}$ , $R_{GK} = 220\ \Omega$	400 - 600V	3000

**Thermal Resistances**

Symbol	Parameter	Value	Unit
$R_{\theta(J-C)}$	Junction to case (AC)	1.5	$^\circ\text{C}/\text{W}$

**Figure 1: Normalized DC Gate Trigger Current vs. Junction Temperature (Sensitive SCR)**

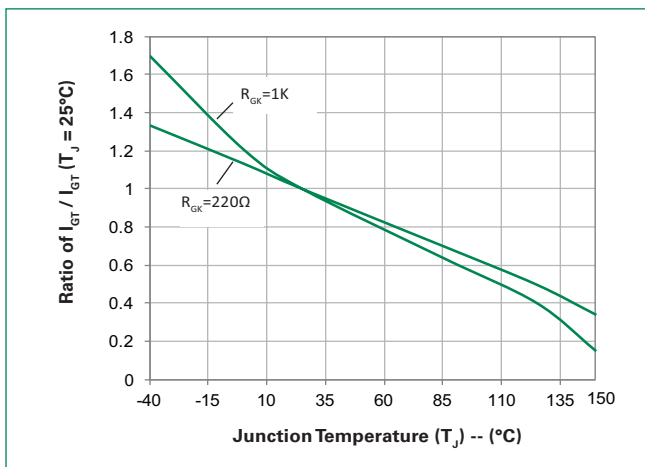

**Figure 2: Normalized DC Gate Trigger Voltage vs. Junction Temperature**

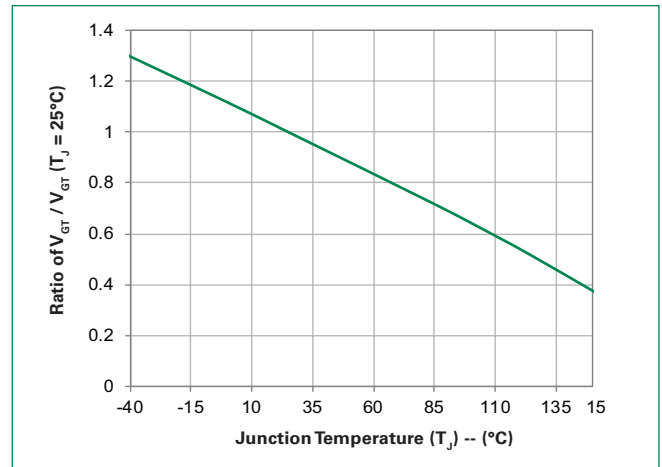

**Figure 3: Normalized DC Holding Current vs. Junction Temperature**

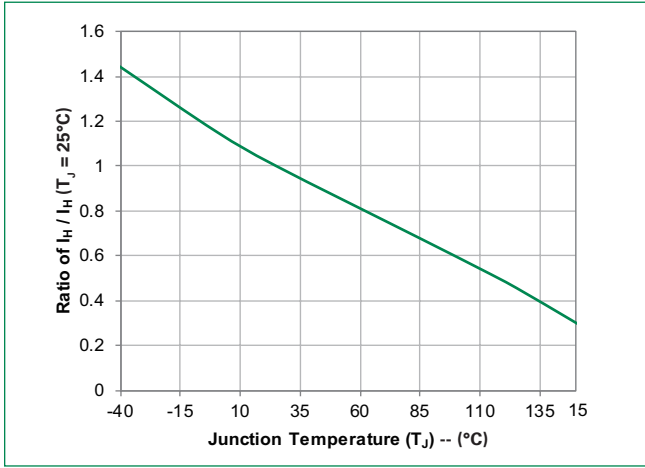

**Figure 4: On-State Current vs. On-State Voltage (Typical)**

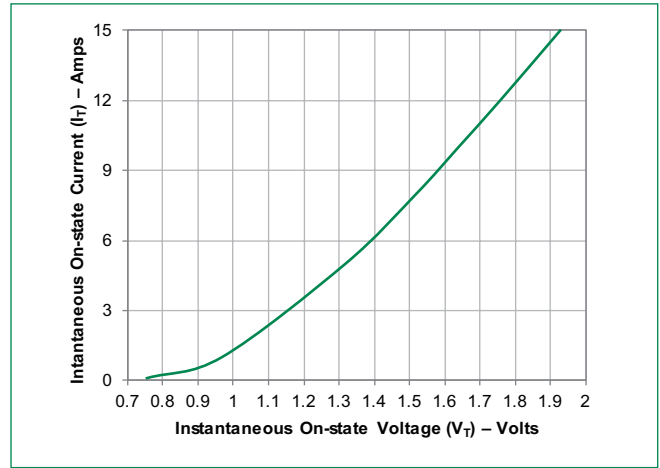

**Figure 5: Power Dissipation (Typical) vs. RMS On-State Current**

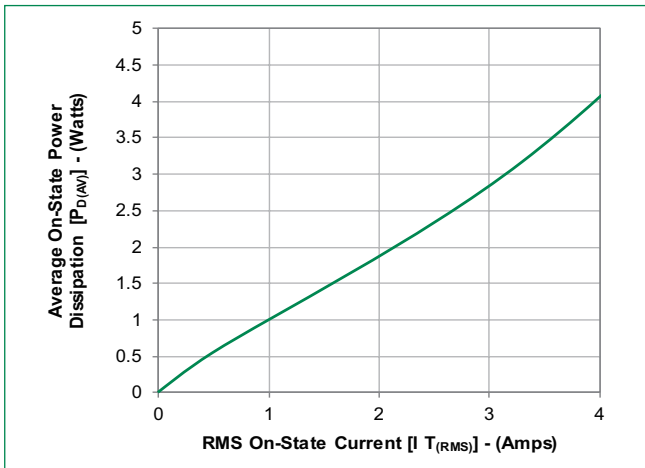

**Figure 6: Maximum Allowable Case Temperature vs. RMS On-State Current**

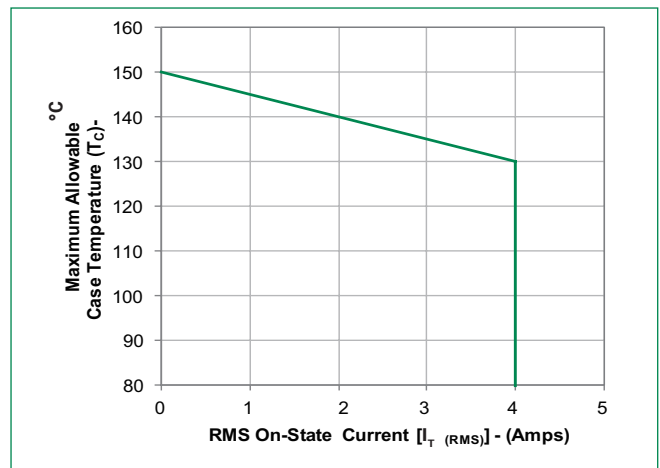

**Figure 7: Maximum Allowable Case Temperature vs. Average On-State Current**

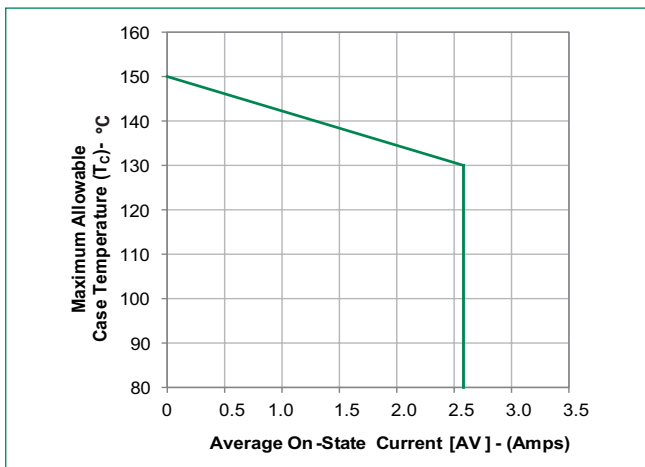

**Figure 8: Peak Capacitor Discharge Current**

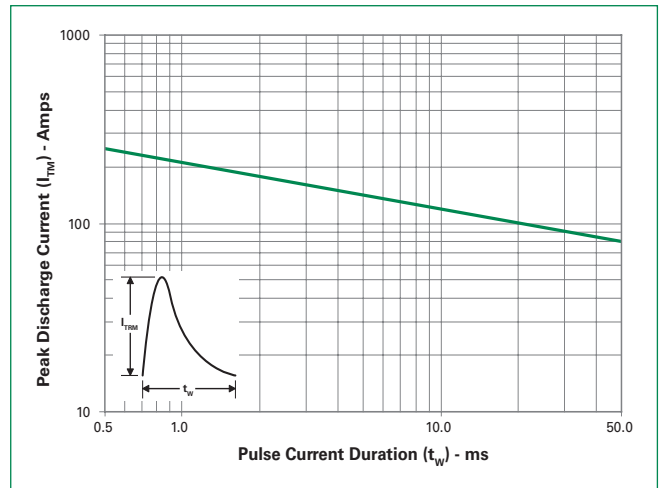

**Figure 9: Surge Peak On-State Current vs. Number of Cycles**

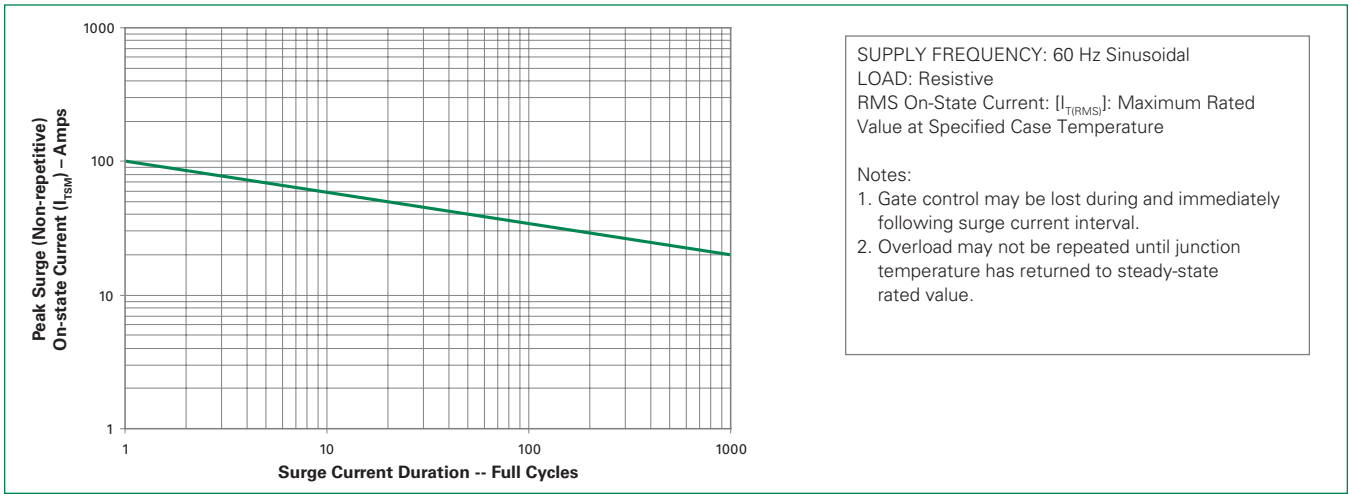

**Figure 10: Typical DC Gate Trigger Current with  $R_{GK}$  vs. Junction Temperature**

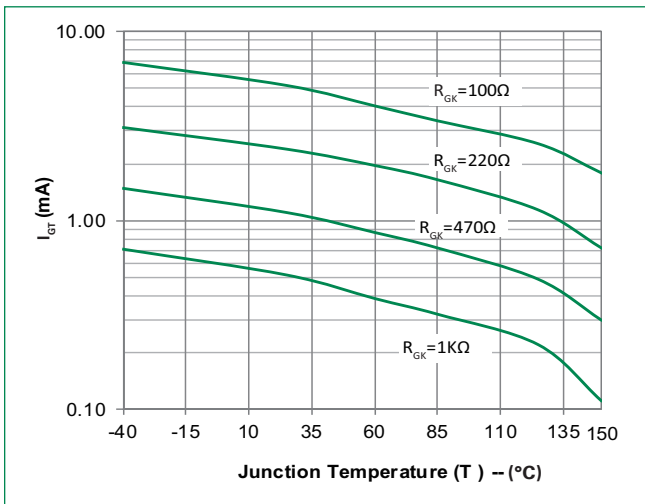

**Figure 11: Typical DC Holding Current with  $R_{GK}$  vs. Junction Temperature**

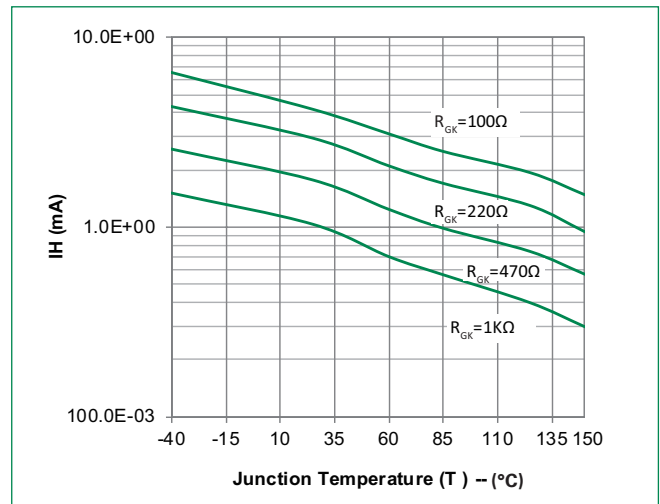

**Figure 12: Typical Static dv/dt with  $R_{GK}$  vs. Junction Temperature**

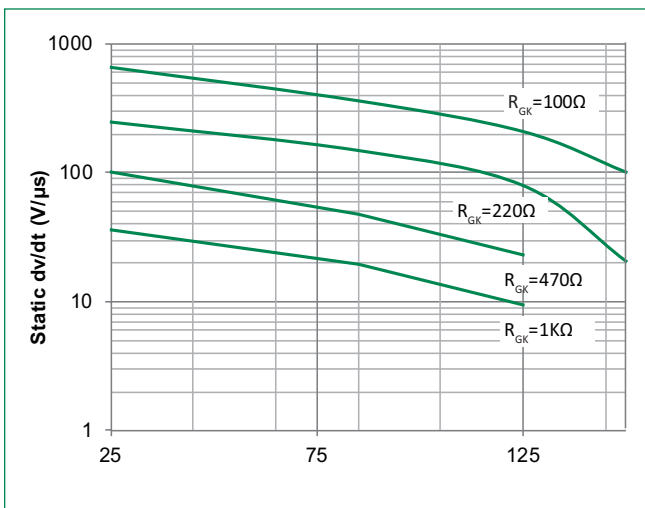

**Soldering Parameters**

Reflow Condition		Pb – Free assembly
Pre Heat	- Temperature Min ( $T_{s(min)}$ )	150°C
	- Temperature Max ( $T_{s(max)}$ )	200°C
	- Time (min to max) ( $t_s$ )	60 – 180 secs
Average ramp up rate (Liquidus Temp ( $T_L$ ) to peak)		5°C/second max
$T_{s(max)}$ to $T_L$ - Ramp-up Rate		5°C/second max
Reflow	- Temperature ( $T_L$ ) (Liquidus)	217°C
	- Time ( $t_L$ )	60 – 150 seconds
Peak Temperature ( $T_p$ )		260 <sup>+0/-5</sup> °C
Time within 5°C of actual peak Temperature ( $t_p$ )		20 – 40 seconds
Ramp-down Rate		5°C/second max
Time 25°C to peak Temperature ( $T_p$ )		8 minutes Max.
Do not exceed		280°C

**Physical Specifications**

<b>Terminal Finish</b>	100% Matte Tin-plated
<b>Body Material</b>	UL Recognized epoxy meeting flammability rating V-0
<b>Lead Material</b>	Copper Alloy

**Design Considerations**

Careful selection of the correct component for the application’s operating parameters and environment will go a long way toward extending the operating life of the Thyristor. Good design practice should limit the maximum continuous current through the main terminals to 75% of the component rating. Other ways to ensure long life for a power discrete semiconductor are proper heat sinking and selection of voltage ratings for worst case conditions. Overheating, overvoltage (including dv/dt), and surge currents are the main killers of semiconductors. Correct mounting, soldering, and forming of the leads also help protect against component damage.

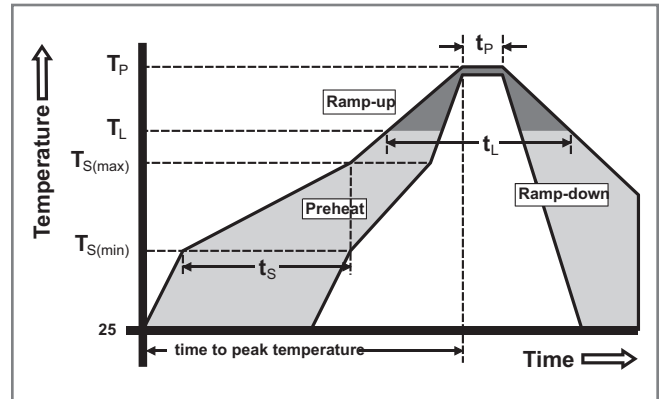

**Environmental Specifications**

Test	Specifications and Conditions
<b>AC Blocking</b>	MIL-STD-750, M-1040, Cond A Applied Peak AC voltage for 1008 hours
<b>Temperature Cycling</b>	MIL-STD-750, M-1051, 100 cycles; -40°C to +150°C; 15-min dwell-time
<b>Temperature/Humidity</b>	EIA / JEDEC, JESD22-A101 1008 hours; 160V - DC: 85°C; 85% rel humidity
<b>High Temp Storage</b>	MIL-STD-750, M-1031, 1008 hours; 150°C
<b>Low-Temp Storage</b>	1008 hours; -40°C
<b>Resistance to Solder Heat</b>	MIL-STD-750 Method 2031
<b>Solderability</b>	ANSI/J-STD-002, category 3, Test A
<b>Lead Bend</b>	MIL-STD-750, M-2036 Cond E
<b>Moisture Sensitivity Level</b>	Level 1, JEDEC-J-STD-020

### Dimensions — TO-251AA (V/I-Package) — V/I-PAK Through Hole

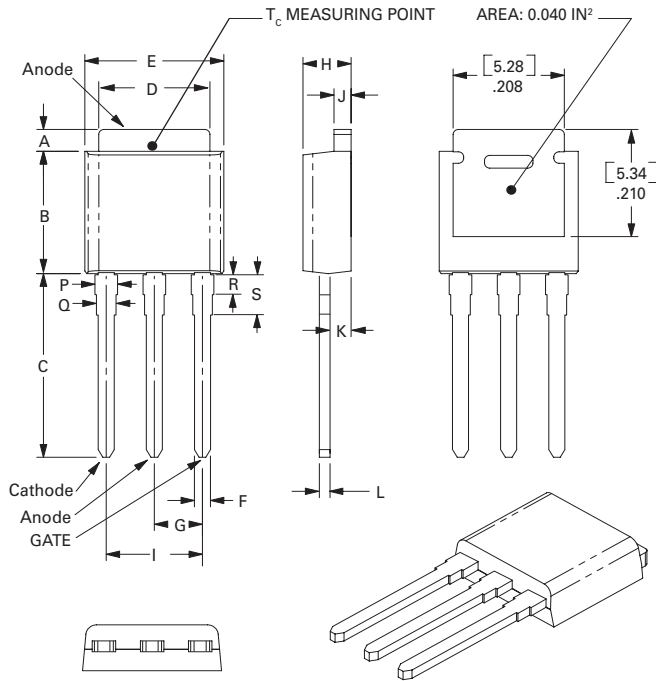

Dimension	Inches			Millimeters		
	Min	Typ	Max	Min	Typ	Max
A	0.037	0.040	0.043	0.94	1.01	1.09
B	0.235	0.242	0.245	5.97	6.15	6.22
C	0.350	0.361	0.375	8.89	9.18	9.53
D	0.205	0.208	0.213	5.21	5.29	5.41
E	0.255	0.262	0.265	6.48	6.66	6.73
F	0.027	0.031	0.033	0.69	0.80	0.84
G	0.087	0.090	0.093	2.21	2.28	2.36
H	0.085	0.092	0.095	2.16	2.34	2.41
I	0.176	0.180	0.184	4.47	4.57	4.67
J	0.018	0.020	0.023	0.46	0.51	0.58
K	0.035	0.037	0.039	0.90	0.95	1.00
L	0.018	0.020	0.023	0.46	0.52	0.58
P	0.042	0.047	0.052	1.06	1.20	1.32
Q	0.034	0.039	0.044	0.86	1.00	1.11
R	0.034	0.039	0.044	0.86	1.00	1.11
S	0.074	0.079	0.084	1.86	2.00	2.11

### Dimensions — TO-252AA (D-Package) — D-PAK Surface Mount

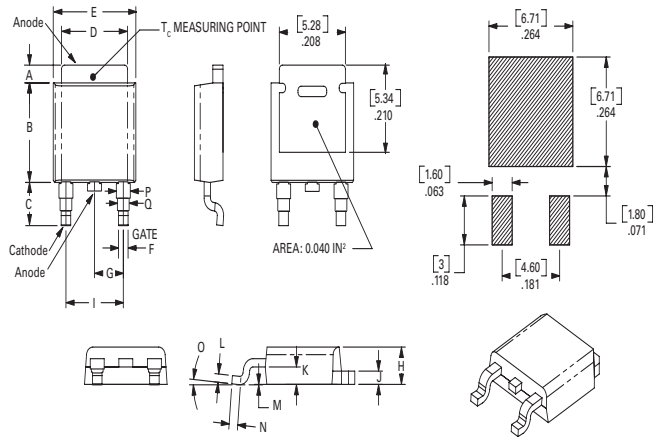

Dimension	Inches			Millimeters		
	Min	Typ	Max	Min	Typ	Max
A	0.037	0.040	0.043	0.94	1.01	1.09
B	0.235	0.243	0.245	5.97	6.16	6.22
C	0.106	0.108	0.113	2.69	2.74	2.87
D	0.205	0.208	0.213	5.21	5.29	5.41
E	0.255	0.262	0.265	6.48	6.65	6.73
F	0.027	0.031	0.033	0.69	0.80	0.84
G	0.087	0.090	0.093	2.21	2.28	2.36
H	0.085	0.092	0.095	2.16	2.33	2.41
I	0.176	0.179	0.184	4.47	4.55	4.67
J	0.018	0.020	0.023	0.46	0.51	0.58
K	0.035	0.037	0.039	0.90	0.95	1.00
L	0.018	0.020	0.023	0.46	0.51	0.58
M	0.000	0.000	0.004	0.00	0.00	0.10
N	0.021	0.026	0.027	0.53	0.67	0.69
O	0°	0°	5°	0°	0°	5°
P	0.042	0.047	0.052	1.06	1.20	1.32
Q	0.034	0.039	0.044	0.86	1.00	1.11

### TO-252 Embossed Carrier Reel Pack (RP) Specifications

#### Meets all EIA-481-2 Standards

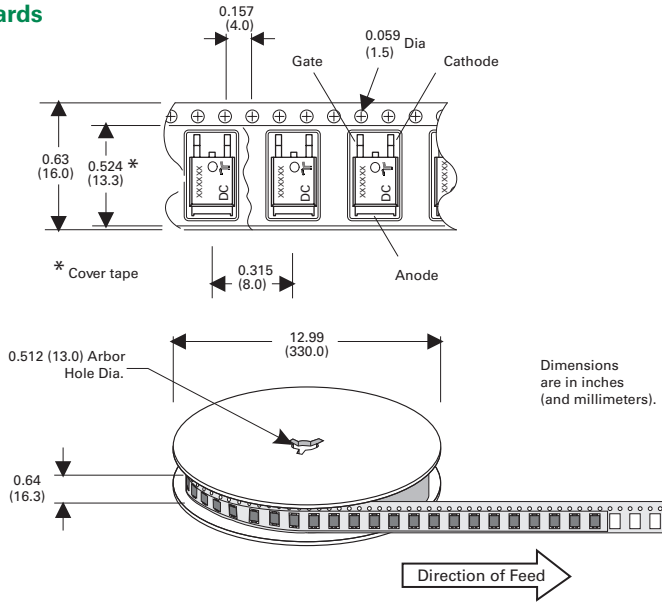

### Product Selector

Part Number	Voltage		Gate Sensitivity	Type	Package
	400V	600V			
SJxx04VS2	X	X	0.2mA	Sensitive SCR	TO-251
SJxx04DS2	X	X	0.2mA	Sensitive SCR	TO-252

Note: xx = Voltage

### Packing Options

Part Number	Marking	Weight	Packing Mode	Base Quantity
SJxx04DS2TP	SJxx04DS2	0.3 g	Tube	750 (75 per tube)
SJxx04DS2RP	SJxx04DS2	0.3 g	Embossed Carrier	2500
SJxx04VS2TP	SJxx04VS2	0.4 g	Tube	750 (75 per tube)

Note: xx = Voltage

### Part Numbering System

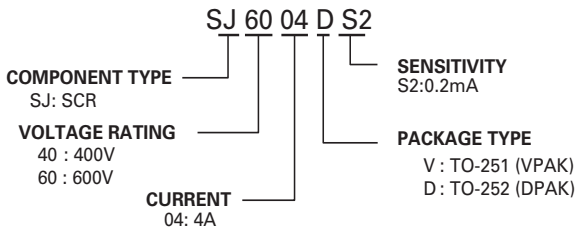

### Part Marking System

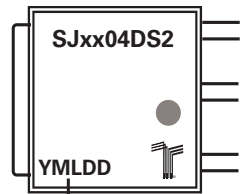

Date Code Marking  
 Y: Year Code  
 M: Month Code  
 L: Location Code  
 DD: Calendar Code

**Disclaimer Notice - Information furnished is believed to be accurate and reliable. However, users should independently evaluate the suitability of and test each product selected for their own applications. Littelfuse products are not designed for, and may not be used in, all applications. Read complete Disclaimer Notice at [www.littelfuse.com/disclaimer-electronics](http://www.littelfuse.com/disclaimer-electronics).**