

S6002xS Series

EV Series 2 A Sensitive SCRs

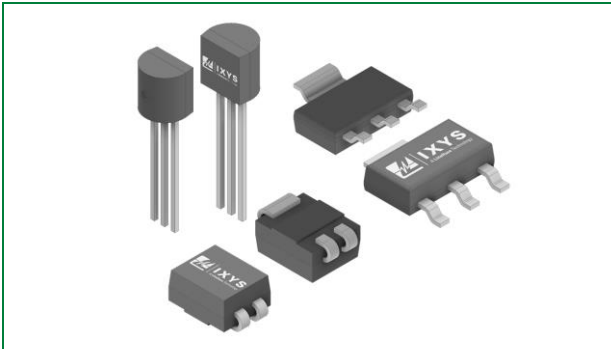

Agency Approvals and Environmental

Environmental Approvals



Schematic Symbol

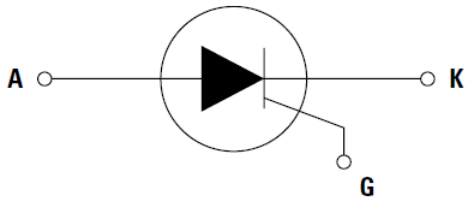

Product Summary

Characteristic	Value	Unit
$I_{T(RMS)}$	2	A
V_{DRM} / V_{RRM}	600	V
I_{GT}	200	μA

Product Description

The S6002xS offers very high di/dt capability through small die planar construction design. It is glass-passivated to ensure long term reliability and parametric stability.

Features

- Surge capability > 25 A
- Blocking voltage (V_{DRM}/V_{RRM}) capability – up to 600 V
- High di/dt capability of 500 A/ μs
- Improved turn-off time (t_q) < 55 μs
- Sensitive gate for direct microprocessor interface
- Through-hole and surface mount packages
- RoHS compliant and Halogen-free

Applications

- The S6002xS is specifically designed for capacitor discharge application such as high-power gas flame ignition.

- 1. Maximum Ratings.....3
- 2. Thermal Characteristics3
- 3. Electrical Characteristics ($T_J = 25\text{ }^\circ\text{C}$ unless otherwise specified)3
- 4. Static Characteristics ($T_J = 25\text{ }^\circ\text{C}$ unless otherwise specified).....3
- 5. Performance Curves4
- 6. Soldering Parameters6
- 7. Physical Specifications.....6
- 8. Environmental Specifications.....6
- 9. Design Considerations.....6
- 10. Package Dimensions7
- 11. Part Numbering and Marking.....8
- 12. Product Selector9
- 13. Packing Options.....9
- 14. Packing Specifications9

1. Maximum Ratings

Symbol	Characteristic	Conditions		Value	Unit
$I_{T(RMS)}$	RMS On-state Current (Full Sine Wave)	TO-92	$T_C = 65\text{ }^\circ\text{C}$	2	A
		SOT-223	$T_C = 95\text{ }^\circ\text{C}$		
		Compak	$T_C = 75\text{ }^\circ\text{C}$		
$I_{T(AV)}$	Average On-state Current	TO-92	$T_C = 65\text{ }^\circ\text{C}$	1.2	A
		SOT-223	$T_C = 95\text{ }^\circ\text{C}$		
		Compak	$T_C = 75\text{ }^\circ\text{C}$		
I_{TSM}	Non-repetitive Surge Peak On-state Current (Full Cycle, T_J Initial = $25\text{ }^\circ\text{C}$)	TO-92	$f = 50\text{ Hz}$	22.5	A
		SOT-223 Compak	$f = 60\text{ Hz}$	25.0	
I^2t	I^2t Value for Fusing		$f = 50\text{ Hz}, t_p = 10\text{ ms}$	2.5	A^2s
di/dt	Critical Rate of Rise of On-state Current $I_G = 10\text{ mA}$	TO-92 SOT-223 Compak	$T_J = 25\text{ }^\circ\text{C}$	500	$\text{A}/\mu\text{s}$
I_{GM}	Peak Gate Current		$t_p = 20\text{ }\mu\text{s}, T_J = 125\text{ }^\circ\text{C}$	1.0	A
$P_{G(AV)}$	Average Gate Power Dissipation		$T_J = 125\text{ }^\circ\text{C}$	0.2	W
T_{STG}	Storage Junction Temperature			-40 to 150	$^\circ\text{C}$
T_J	Operating Junction Temperature			-40 to 125	$^\circ\text{C}$

2. Thermal Characteristics

Symbol	Characteristic		Value	Unit	
$R_{th(JC)}$	Thermal Resistance, junction-to-case (AC)	$I_T = 1.5\text{ A}_{(RMS)}$	TO-92	30	$^\circ\text{C}/\text{W}$
			SOT-223	15	
			Compak	25	
$R_{th(JA)}$	Thermal Resistance, junction-to-ambient (AC)	$I_T = 1.5\text{ A}_{(RMS)}$	TO-92	160	$^\circ\text{C}/\text{W}$
			SOT-223	60	

3. Electrical Characteristics ($T_J = 25\text{ }^\circ\text{C}$ unless otherwise specified)

Symbol	Description	Conditions	Value		Unit
			Min	Max	
I_{GT}	DC Gate Trigger Current	$V_D = 6\text{ V}, R_L = 100\text{ }\Omega$	20	200	μA
V_{GT}	DC Gate Trigger Voltage	$V_D = 6\text{ V}, R_L = 100\text{ }\Omega$	-	0.8	V
V_{GRM}	Peak Reverse Gate Voltage	$I_{RG} = 10\text{ }\mu\text{A}$	5	-	V
I_H	Holding Current	$R_{GK} = 1\text{ k}\Omega$	-	5	mA
V_{GD}	Gate Non-trigger Voltage	$V_D = V_{DRM}, R_{GK} = 1\text{ k}\Omega, T_J = 125\text{ }^\circ\text{C}$	0.2	-	V
dv/dt	Critical Rate-of-rise of Off-stage Voltage	$T_J = 125\text{ }^\circ\text{C}, V_D = 67\% V_{DRM}, \text{Exponential Waveform}, R_{GK} = 1\text{ k}\Omega$	25	-	$\text{V}/\mu\text{s}$
t_q	Turn-off Time	$I_T = 0.5\text{ A}$	-	55	μs
t_{gt}	Turn-on Time	$I_G = 10\text{ mA}, P_W = 15\text{ }\mu\text{sec}, I_T = 3.0\text{ A}_{(PK)}$	-	5	μs

4. Static Characteristics ($T_J = 25\text{ }^\circ\text{C}$ unless otherwise specified)

Symbol	Description	Conditions	Value		Unit
			Min	Max	
V_{TM}	Peak On-state Voltage	$I_{TM} = 3\text{ A}_{(PK)}, t_p = 380\text{ }\mu\text{s}$	-	1.5	V
I_{DRM}/I_{RRM}	Off-state Current, Peak Repetitive	$T_J = 25\text{ }^\circ\text{C} @ V_D = V_{DRM}, R_{GK} = 1\text{ k}\Omega$	-	5	μA
		$T_J = 125\text{ }^\circ\text{C} @ V_D = V_{DRM}, R_{GK} = 1\text{ k}\Omega$	-	500	μA

5. Performance Curves

Figure 1. Normalized DC Gate Trigger Current vs. Junction Temperature

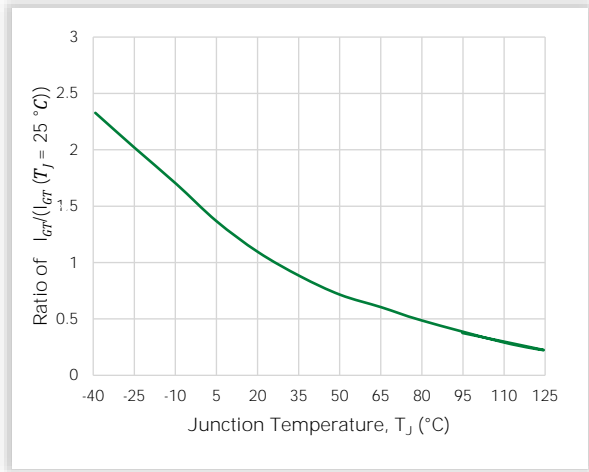

Figure 2. Normalized DC Gate Trigger Voltage vs. Junction Temperature

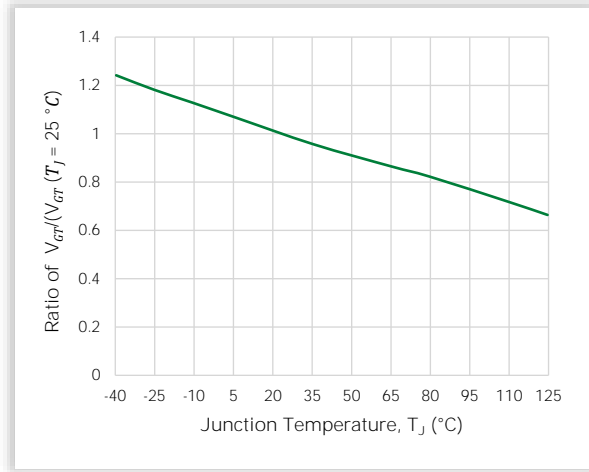

Figure 3. Normalized DC Holding Current vs. Junction Temperature

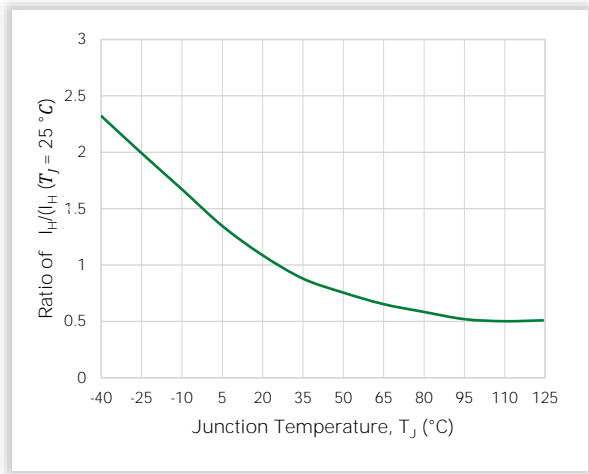

Figure 4. Typical On-state Current vs. On-state Voltage

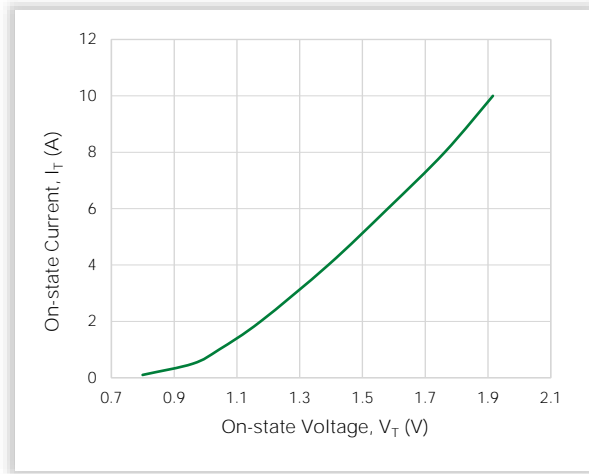

Figure 5. Typical Power Dissipation vs. RMS On-state Current

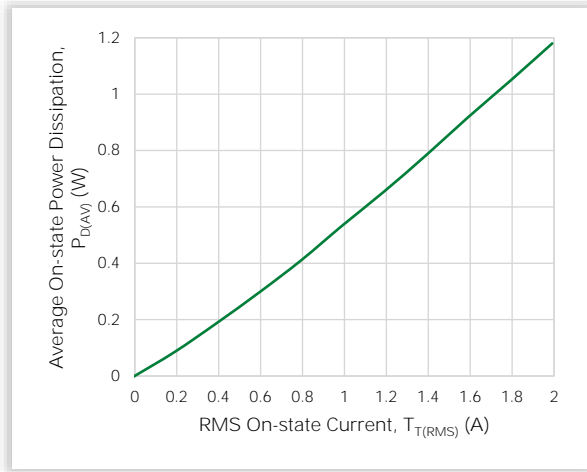

Figure 6. Maximum Allowable Case Temperature vs. RMS On-state Current

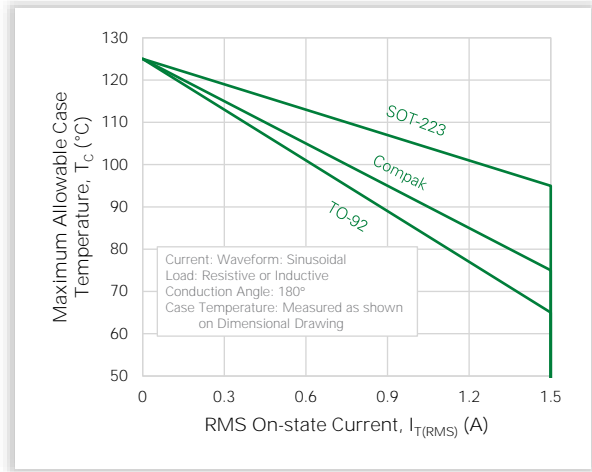
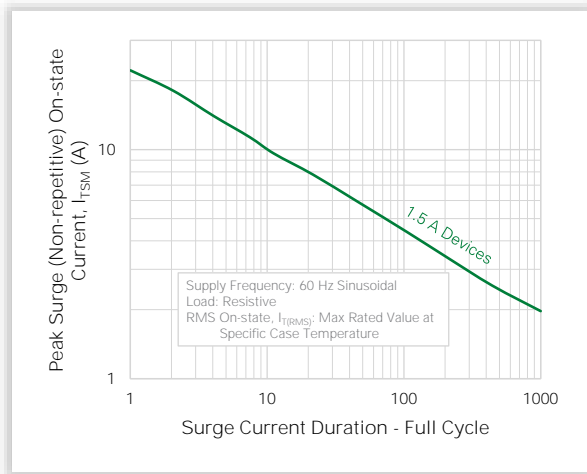

Figure 7. Surge Peak On-state Current vs. Number of Cycles



Notes:

1. Gate control may be lost during and immediately following surge current interval.
2. Overload may not be repeated until junction temperature has returned to steady-state rated value.

Figure 8. Peak Repetitive Capacitor Discharge Current

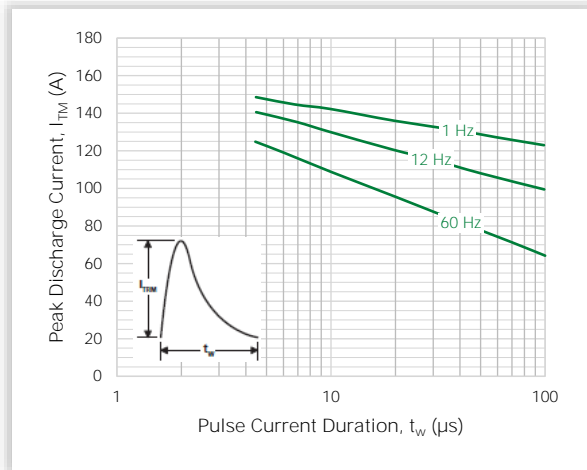
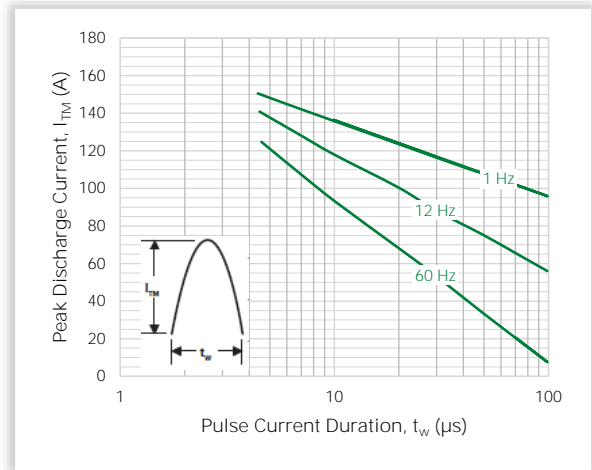
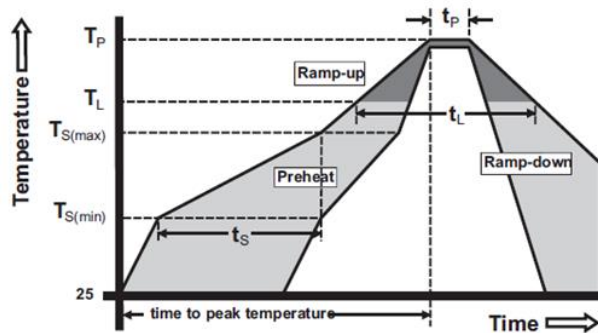

Figure 9. Peak Repetitive Sinusoidal Pulse Current



6. Soldering Parameters



Parameter	Value	
Reflow Condition	Pb-free Assembly	
Pre-Heat	Temperature Min, $T_{S(min)}$	150 °C
	Temperature Max, $T_{S(max)}$	200 °C
	Time (Min to Max), t_s	60 to 180 s
Average Ramp-up Rate Liquidus Temp., T_L to peak	5 °C/s (Max)	
$T_{S(max)}$ to T_L Ramp-up Rate	5 °C/s (Max)	
Reflow	Temperature, T_L Liquidus	217 °C
	Time, t_L	60 to 150 s
Peak Temperature, T_P	260 °C (± 5 °C)	
Time within 5 °C of Actual Peak Temperature, t_P	20 to 40 s	
Ramp-down Rate	5 °C/s (Max)	
Time 25 °C to Peak Temperature, T_P	8 minutes (Max)	
Do Not Exceed	280 °C	

7. Physical Specifications

Device Feature	Detail
Terminal Finish	100% Matte Tin-plated
Body Material	UL Recognized Epoxy meeting Flammability Rating 94 V-0
Terminal Material	Copper Alloy

9. Design Considerations

Careful selection of the correct component for the application's operating parameters and environment will go a long way toward extending the operating life of the Thyristor. Good design practice should limit the maximum continuous current through the main terminals to 75% of the component rating. Other ways to ensure long life for a power discrete semiconductor are proper heat sinking and selection of voltage ratings for worst case conditions. Overheating, overvoltage (including dv/dt), and surge currents are the main killers of semiconductors. Correct mounting, soldering, and forming of the leads also help protect against component damage.

8. Environmental Specifications

Test	Specifications and Conditions
AC Blocking	MIL-STD-750, M-1040, Cond A Applied Peak AC voltage @ 125°C for 1008 hours
Temperature Cycling	MIL-STD-750, M-1051, 1000 cycles; -40°C to +150°C; 15 min dwell time
Temperature/Humidity	EIA / JEDEC, JESD22-A101 1008 hours; 160V - DC; 85°C; 85% relative humidity
High-temp Storage	MIL-STD-750, M-1031, 1008 hours; 150°C
Low-temp Storage	1008 hours; -40°C
Resistance to Solder Heat	MIL-STD-750 Method 2031
Solderability	ANSI/J-STD-002, category 3, Test A
Lead Bend	MIL-STD-750, M-2036 Cond E

10. Package Dimensions

TO-92 (E- Package)

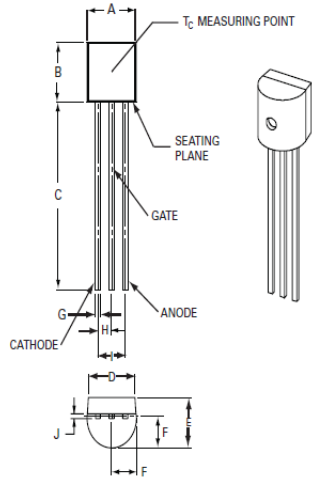

Dimension	Millimeters		Inches	
	Min	Max	Min	Max
A	4.450	5.200	0.175	0.205
B	4.320	5.330	0.170	0.210
C	12.700	-	0.500	-
D	3.430	-	0.135	-
E	3.180	4.190	0.125	0.165
F	2.040	2.660	0.080	0.105
G	0.407	0.533	0.016	0.021
H	1.150	1.390	0.045	0.055
I	2.420	2.660	0.095	0.105
J	0.380	0.500	0.015	0.020

SOT-223

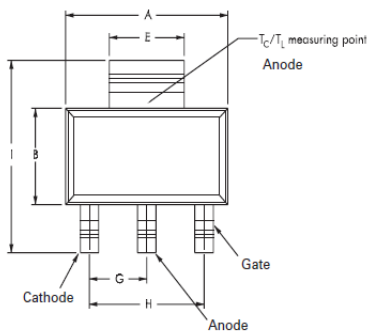

Pad Layout for SOT-223

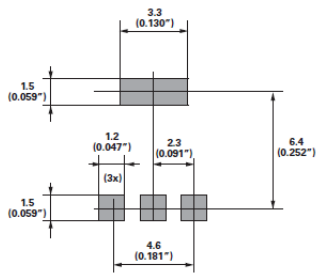

Dimensions in Millimeters (Inches)

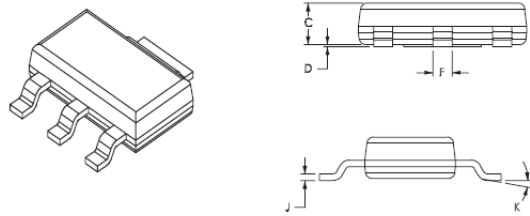

Dimension	Millimeters			Inches		
	Min	Typ	Max	Min	Typ	Max
A	6.30	6.50	6.70	0.248	0.256	0.264
B	3.30	3.50	3.70	0.130	0.138	0.146
C	-	-	1.80	-	-	0.071
D	0.02	-	0.10	0.001	-	0.004
E	2.90	3.00	3.15	0.114	0.118	0.124
F	0.60	0.70	0.85	0.024	0.027	0.034
G	-	2.30	-	-	0.090	-
H	-	4.60	-	-	0.181	-
I	6.70	7.00	7.30	0.264	0.276	0.287
J	0.24	0.26	0.35	0.009	0.010	0.014
K	10° Max					

Compak (C- Package)

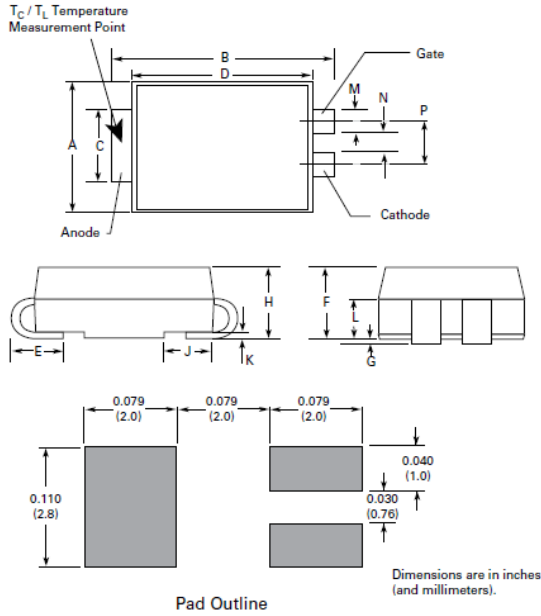

Dimension	Millimeters		Inches	
	Min	Max	Min	Max
A	3.30	3.95	0.130	0.156
B	5.10	5.60	0.201	0.220
C	1.95	2.20	0.077	0.087
D	4.05	4.60	0.159	0.181
E	0.75	1.60	0.030	0.063
F	1.90	2.45	0.075	0.096
G	0.05	0.20	0.002	0.008
H	1.95	2.65	0.077	0.104
J	1.09	1.35	0.043	0.053
K	0.15	0.41	0.006	0.016
L	0.76	1.40	0.030	0.055
M	0.56	0.71	0.022	0.028
N	0.69	0.84	0.027	0.033
P	1.32	1.47	0.052	0.058

11. Part Numbering and Marking

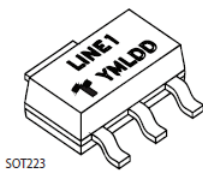
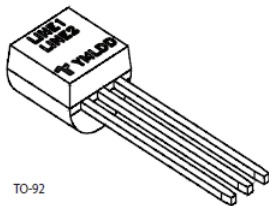
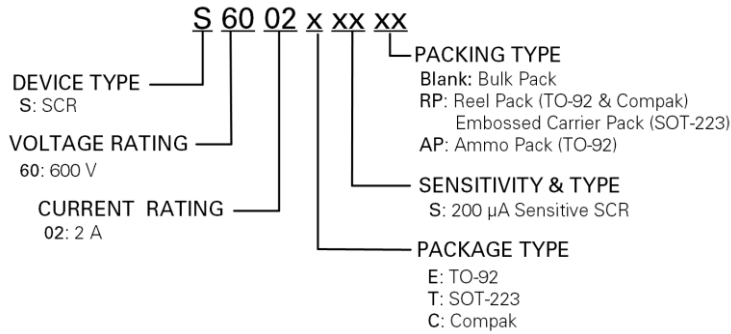

Line1 = Littelfuse Part Number
Line2 = continuation...Littelfuse Part Number
Y = Last Digit of Calendar Year
M = Letter Month Code (A-L for Jan-Dec)
L = Location Code
DD = Calendar Date

Compak (C Package)



Date Code Marking
Y: Year Code
M: Month Code
XXX: Lot Trace Code

12. Product Selector

Part Number	Voltage	Gate Sensitivity	Package
	600 V		
S6002ES	X	200 μ A	TO-92
S6002TS	X	200 μ A	SOT-223
S6002CS	X	200 μ A	Compak

13. Packing Options

Part Number	Marking	Weight	Packing Mode	M.O.Q
S6002ES	S6002ES	0.217 g	Bulk	2500
S6002ESAP	S6002ES	0.217 g	Ammo Pack	2000
S6002ESRP	S6002ES	0.217 g	Tape & Reel	2000
S6002TSRP	S6002TS	0.120 g	Tape & Reel	1000
S6002CSR	S6002CS	0.120 g	Tape & Reel	2500

14. Packing Specifications

TO-92 (3-Lead) Reel Pack (RP) Radial Leaded Specifications

Meets all EIA-468-C Standards

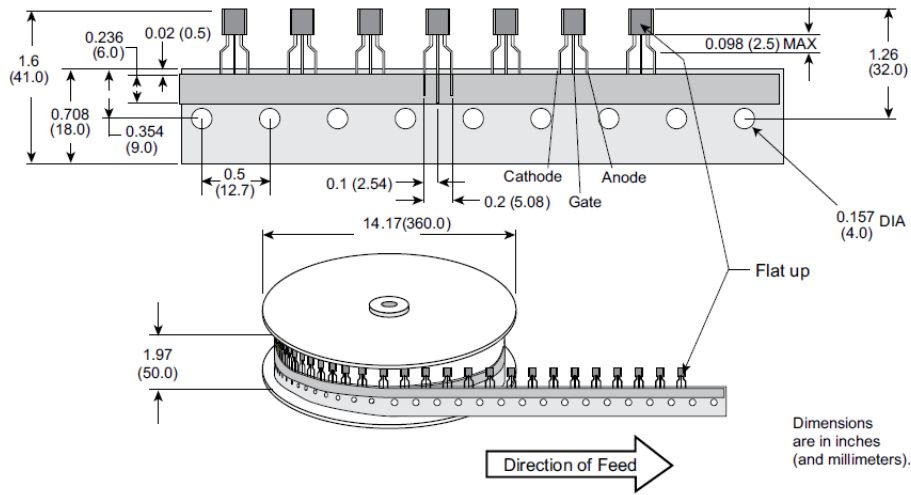

TO-92 (3-Lead) Ammo Pack (AP) Radial Leaded Specifications

Meets all EIA-468-C Standards

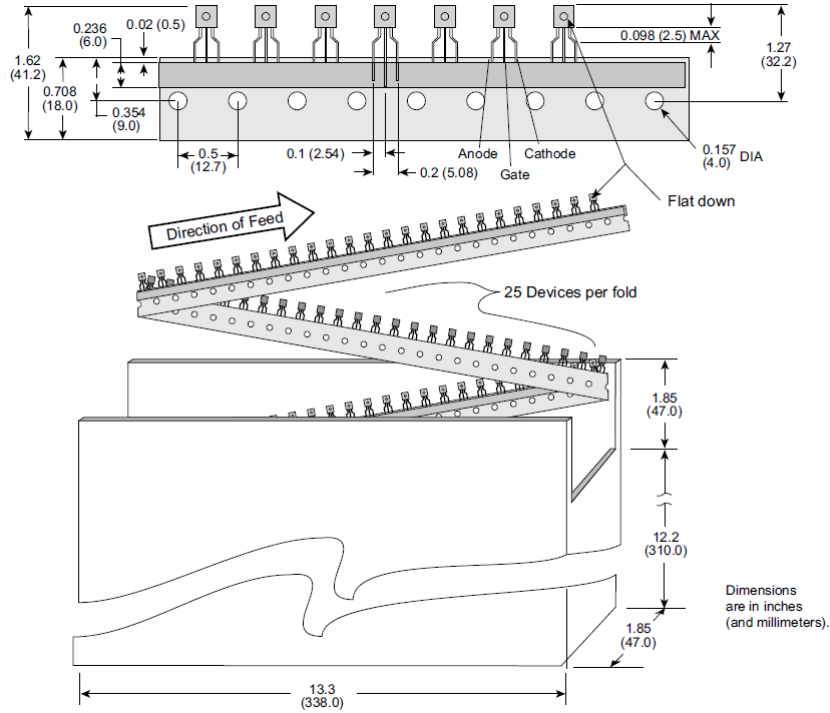

SOT-223 Reel Pack (RP) Specifications

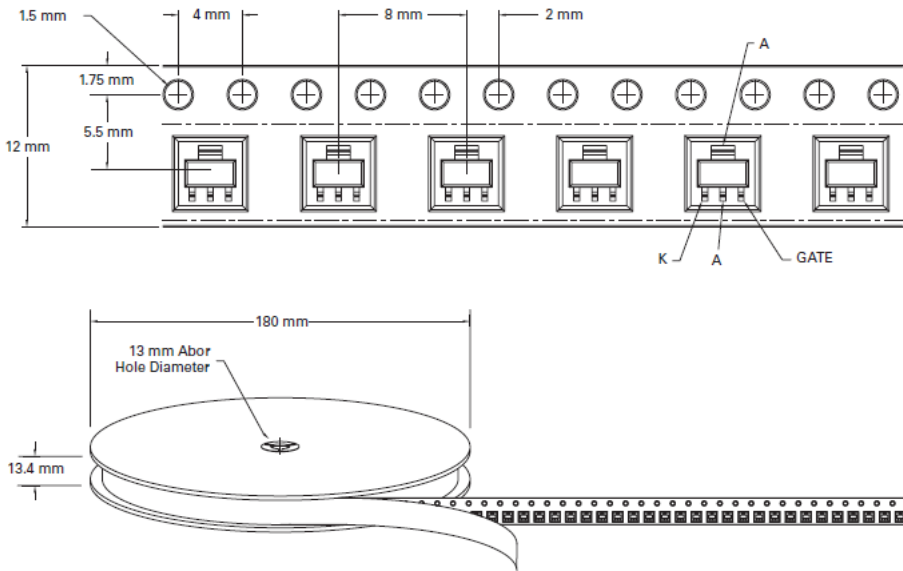

Compak Embossed Carrier Reel Pack (RP) Specifications

Meets all EIA-481-1 Standards

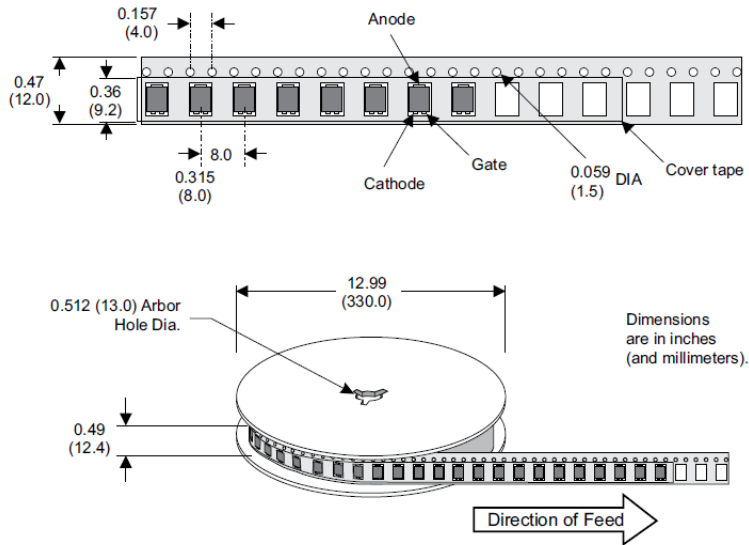

For additional information please visit www.Littelfuse.com/powersemi

Disclaimer Notice - Littelfuse products are not designed for, and shall not be used for, any purpose (including, without limitation, automotive, military, aerospace, medical, life-saving, life-sustaining or nuclear facility applications, devices intended for surgical implant into the body, or any other application in which the failure or lack of desired operation of the product may result in personal injury, death, or property damage) other than those expressly forth in applicable Littelfuse product documentation. Littelfuse shall not be liable for any claims or damages arising out of products used in applications not expressly intended by Littelfuse as set forth in applicable Littelfuse documentation.

Read complete Disclaimer Notice at www.littelfuse.com/disclaimer-electronics