

QJ8012xHx Series

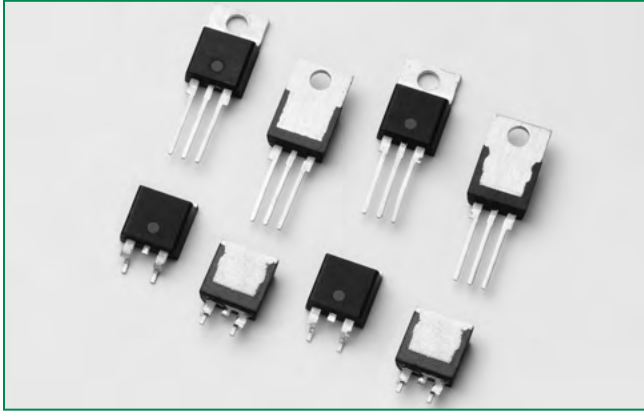

Agency Recognitions

Agency	Agency File Number
	E71639*

* - L Package only

Main Features

Symbol	Value	Unit
$I_{T(RMS)}$	12	A
V_{DRM}/V_{RRM}	800	V
$I_{GT(Q1)}$	35 or 50	mA

Schematic Symbol

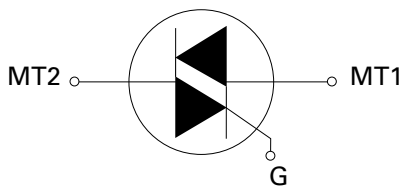

Description

This 12A high temperature Alternistor TRIAC, offered in TO-220AB, TO-220 isolated and TO-263 package, has 150°C maximum junction temperature and 120A ITSM(60Hz).

This series enables easier thermal management and higher surge handling capability in AC power control applications such as heater control, motor speed control, lighting controls, and static switching relays. Alternistor TRIAC operates in quadrants I, II, & III and offers high performance in applications requiring high commutation capability.

Features & Benefits

- Recognized to UL 1557 as an Electrically Isolated Semiconductor Devices
- Glass – passivated junctions
- Surge capability up to 120 A
- The L-package has an isolation rating of 2500V_{RMS}
- Solid-state switching eliminates arcing or contact bounce that create voltage transients
- No contacts to wear out from reaction of switching events
- Restricted (or limited) RFI generation, depending on activation point sine wave
- Requires only a small gate activation pulse in each half-cycle
- RoHS-compliant

Applications

Excellent for AC switching and phase control applications such as heating, lighting, and motor speed controls.

Typical applications are AC solid-state switches, light dimmers, power tools, lawn care equipment, home/brown goods and white goods appliances.

Alternistor Triacs (no snubber required) are used in applications with extremely inductive loads requiring highest commutation performance.

Internally constructed isolated packages are offered for ease of heat sinking with highest isolation voltage.

Absolute Maximum Ratings — Alternistor (3 Quadrants)

Symbol	Parameter	Value	Unit
$I_{T(RMS)}$	RMS on-state current (full sine wave)	QJxx12LHy $T_C = 120^\circ\text{C}$	12 A
		QJxx12RHx QJxx12NHx $T_C = 132^\circ\text{C}$	
I_{TSM}	Non repetitive surge peak on-state current (full cycle, T_J initial = 25°C)	$f = 50$ Hz $t = 20$ ms	110 A
		$f = 60$ Hz $t = 16.7$ ms	120 A
I^2t	I^2t Value for fusing	$t_p = 8.3$ ms	60 A^2s
di/dt	Critical rate of rise of on-state current	$f = 60$ Hz $T_J = 150^\circ\text{C}$	70 $\text{A}/\mu\text{s}$
I_{GTM}	Peak gate trigger current	$t_p = 20$ μs $T_J = 150^\circ\text{C}$	4 A
$P_{G(AV)}$	Average gate power dissipation	$T_J = 150^\circ\text{C}$	0.5 W
T_{stg}	Storage temperature range		-40 to 150 $^\circ\text{C}$
T_J	Operating junction temperature range		-40 to 150 $^\circ\text{C}$
V_{DSM}/V_{RSM}	Peak non-repetitive blocking voltage	Pulse Width = 100 μs	$V_{DRM}/V_{RRM} + 200$ V

Note: xx = voltage/10, y = sensitivity

Electrical Characteristics ($T_J = 25^\circ\text{C}$, unless otherwise specified) — Alternistor Triac (3 Quadrants)

Symbol	Test Conditions	Quadrant	QJxx12xH4	QJxx12H5	Unit
I_{GT}	$V_D = 12\text{V}$ $R_L = 60\ \Omega$	I – II – III	MAX.	35	50 mA
V_{GT}	$V_D = 12\text{V}$ $R_L = 60\ \Omega$	I – II – III	MAX.	1.3	1.3 V
V_{GD}	$V_D = V_{DRM}$ $R_L = 3.3\ \text{k}\Omega$ $T_J = 150^\circ\text{C}$	I – II – III	MIN.	0.2	0.2 V
I_H	$I_T = 100\text{mA}$		MAX.	40	50 mA
dv/dt	$V_D = V_{DRM}$ Gate Open $T_J = 150^\circ\text{C}$	MIN.	450	700	$\text{V}/\mu\text{s}$
	$V_D = 67\% V_{DRM}$ Gate Open $T_J = 100^\circ\text{C}$		600	1000	
$(dv/dt)_c$	$(di/dt)_c = 6.5\ \text{A}/\text{ms}$ $T_J = 150^\circ\text{C}$	MIN.	2	30	$\text{V}/\mu\text{s}$
t_{gt}	$I_G = 2 \times I_{GT}$ $\text{PW} = 15\ \mu\text{s}$ $I_T = 17.0\ \text{A}(\text{pk})$	TYP.	7	9	μs

Static Characteristics

Symbol	Test Conditions	Value	Unit	
V_{TM}	$I_{TM} = 17.0\ \text{A}$ $t_p = 380\ \mu\text{s}$	MAX.	1.60 V	
I_{DRM}/I_{RRM}	$V_D = V_{DRM}/V_{RRM}$	$T_J = 25^\circ\text{C}$	MAX.	10 μA
		$T_J = 150^\circ\text{C}$		3 mA

Thermal Resistances

Symbol	Parameter	Value	Unit
$R_{\theta(J-C)}$	Junction to case (AC)	QJxx12RHx QJxx12NHx	1.2 $^\circ\text{C}/\text{W}$
		QJxx12LHy	2.3 $^\circ\text{C}/\text{W}$
$R_{\theta(J-A)}$	Junction to ambient (AC)	QJxx12RHx	45 $^\circ\text{C}/\text{W}$
		QJxx12LHy	90 $^\circ\text{C}/\text{W}$

Note: xx = voltage/10, y = sensitivity

Figure 1: Definition of Quadrants

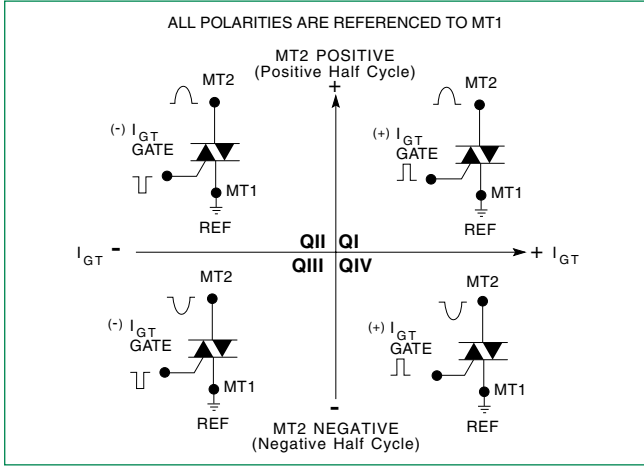

Note: Alternistors will not operate in QIV

Figure 2: Normalized DC Gate Trigger Current for All Quadrants vs. Junction Temperature

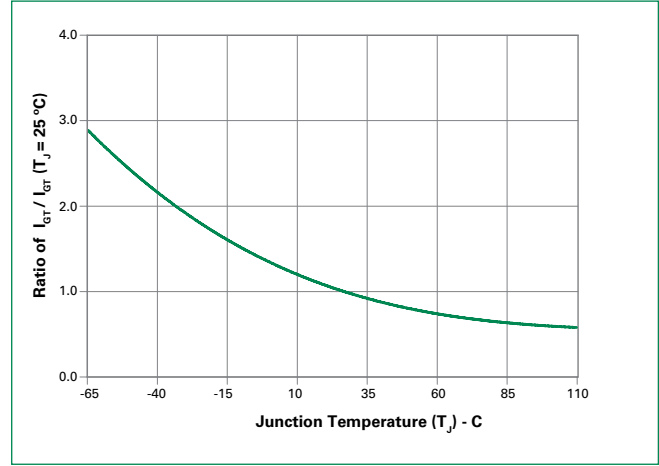

Figure 3: Normalized DC Holding Current vs. Junction Temperature

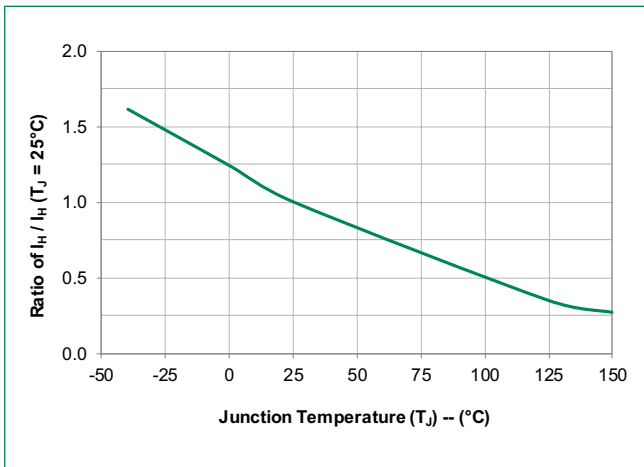

Figure 4: Normalized DC Gate Trigger Voltage for All Quadrants vs. Junction Temperature

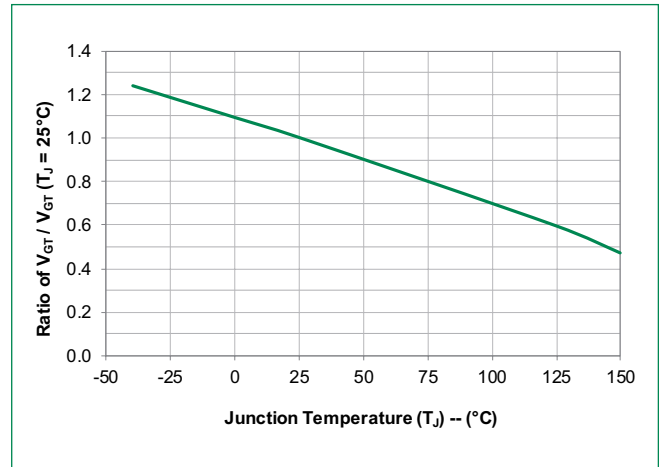

Figure 5: Power Dissipation (Typical) vs. RMS On-State Current

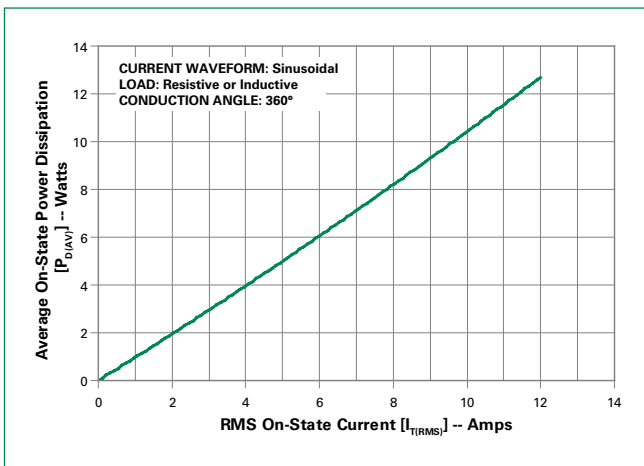

Figure 6: Maximum Allowable Case Temperature vs. On-State Current

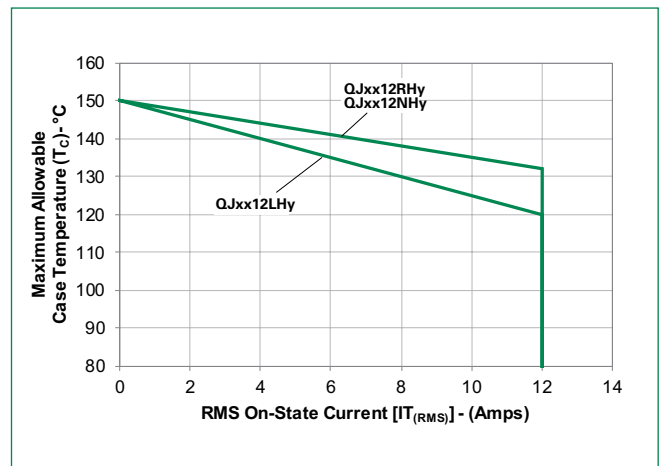

Figure 7: Maximum Allowable Ambient Temperature vs. On-State Current

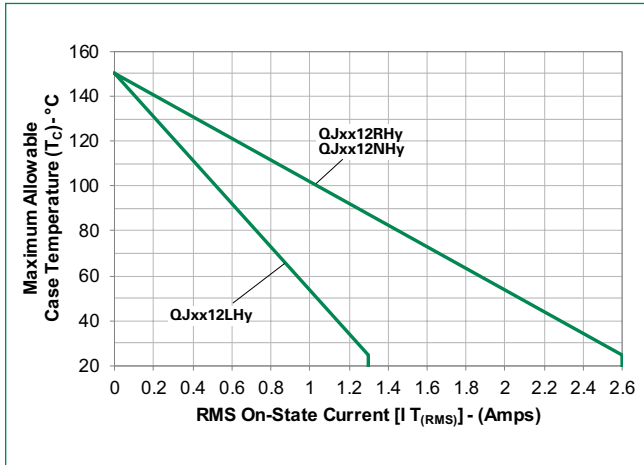

Figure 8: On-State Current vs. On-State Voltage (Typical)

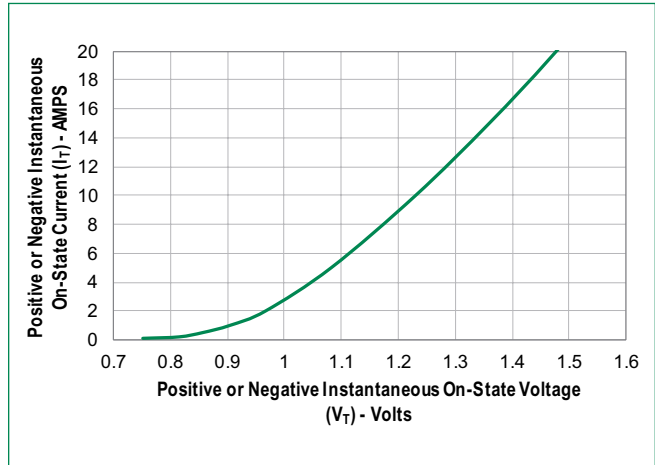
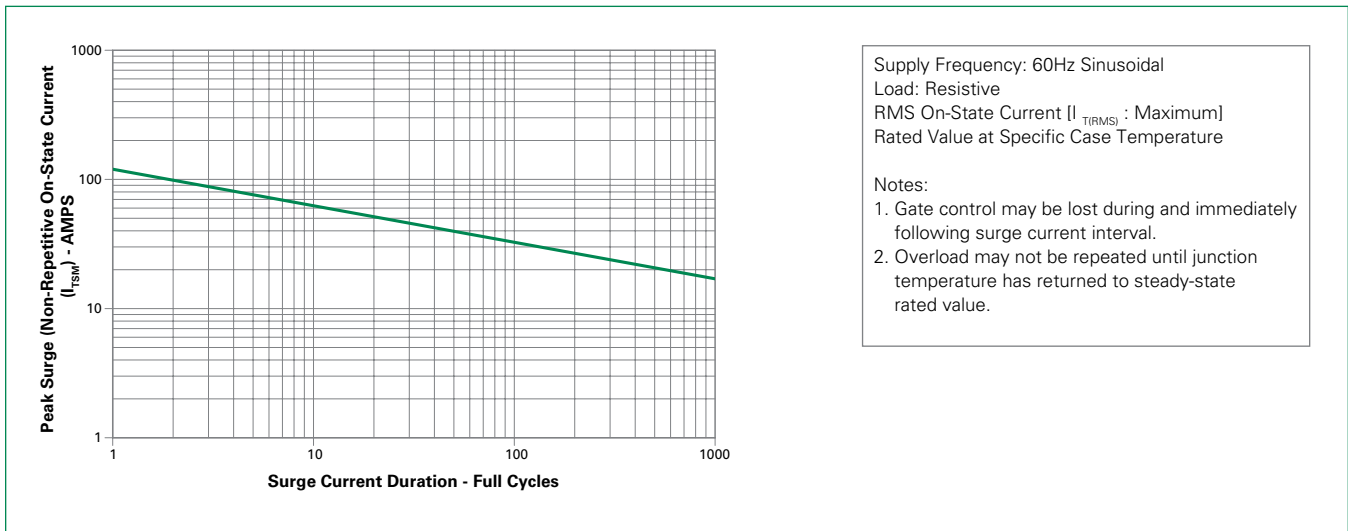
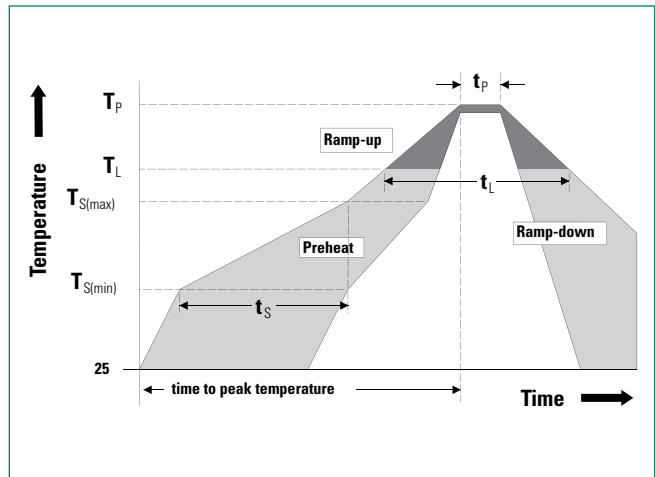

Figure 9: Surge Peak On-State Current vs. Number of Cycles



Soldering Parameters

Reflow Condition		Pb – Free assembly
Pre Heat	- Temperature Min ($T_{s(min)}$)	150°C
	- Temperature Max ($T_{s(max)}$)	200°C
	- Time (min to max) (t_s)	60 – 180 secs
Average ramp up rate (Liquidus Temp) (T_L) to peak		5°C/second max
$T_{S(max)}$ to T_L - Ramp-up Rate		5°C/second max
Reflow	- Temperature (T_L) (Liquidus)	217°C
	- Time (min to max) (t_s)	60 – 150 seconds
Peak Temperature (T_p)		260 ^{+0/-5} °C
Time within 5°C of actual peak Temperature (t_p)		20 – 40 seconds
Ramp-down Rate		5°C/second max
Time 25°C to peak Temperature (T_p)		8 minutes Max.
Do not exceed		280°C



Physical Specifications

Terminal Finish	100% Matte Tin-plated
Body Material	UL Recognized compound meeting flammability rating V-0
Terminal Material	Copper Alloy

Design Considerations

Careful selection of the correct component for the application's operating parameters and environment will go a long way toward extending the operating life of the Thyristor. Good design practice should limit the maximum continuous current through the main terminals to 75% of the component rating. Other ways to ensure long life for a power discrete semiconductor are proper heat sinking and selection of voltage ratings for worst case conditions. Overheating, overvoltage (including dv/dt), and surge currents are the main killers of semiconductors. Correct mounting, soldering, and forming of the leads also help protect against component damage.

Environmental Specifications

Test	Specifications and Conditions
AC Blocking	MIL-STD-750, M-1040, Cond A Applied Peak AC voltage @ 125°C for 1008 hours
Temperature Cycling	MIL-STD-750, M-1051, 100 cycles; -40°C to +150°C; 15-min dwell time
Temperature/Humidity	EIA / JEDEC, JESD22-A101 1008 hours; 320V - DC: 85°C; 85% rel humidity
High Temp Storage	MIL-STD-750, M-1031, 1008 hours; 150°C
Low-Temp Storage	1008 hours; -40°C
Resistance to Solder Heat	MIL-STD-750 Method 2031
Solderability	ANSI/J-STD-002, category 3, Test A
Lead Bend	MIL-STD-750, M-2036 Cond E

Dimensions — TO-220AB (R-Package) — Non-Isolated Mounting Tab Common with Center Lead

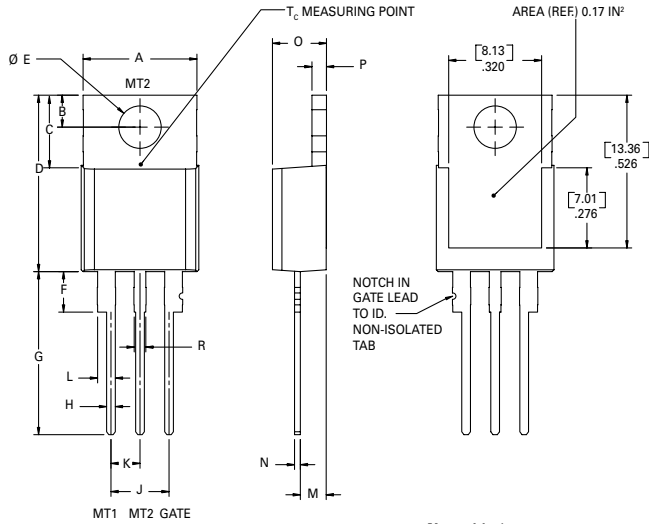

Note: Maximum torque to be applied to mounting tab is 8 in-lbs. (0.904 Nm).

Dimension	Inches		Millimeters	
	Min	Max	Min	Max
A	0.380	0.420	9.65	10.67
B	0.105	0.115	2.67	2.92
C	0.230	0.250	5.84	6.35
D	0.590	0.620	14.99	15.75
E	0.142	0.147	3.61	3.73
F	0.110	0.130	2.79	3.30
G	0.540	0.575	13.72	14.61
H	0.025	0.035	0.64	0.89
J	0.195	0.205	4.95	5.21
K	0.095	0.105	2.41	2.67
L	0.060	0.075	1.52	1.91
M	0.085	0.095	2.16	2.41
N	0.018	0.024	0.46	0.61
O	0.178	0.188	4.52	4.78
P	0.045	0.060	1.14	1.52
R	0.038	0.048	0.97	1.22

Dimensions — TO-220AB (L-Package) — Isolated Mounting Tab

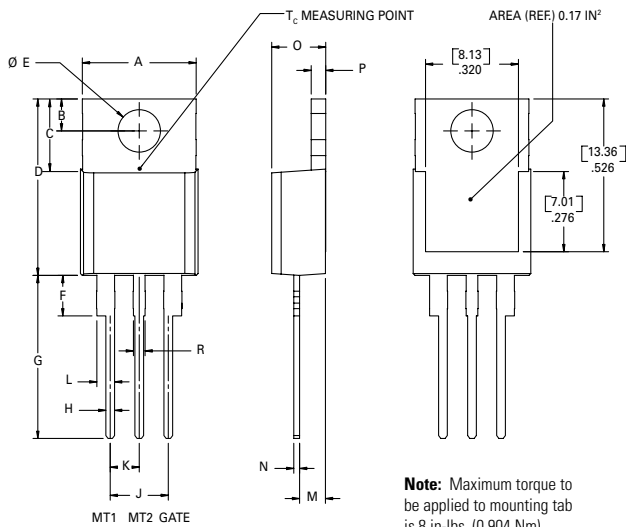

Note: Maximum torque to be applied to mounting tab is 8 in-lbs. (0.904 Nm).

Dimension	Inches		Millimeters	
	Min	Max	Min	Max
A	0.380	0.420	9.65	10.67
B	0.105	0.115	2.67	2.92
C	0.230	0.250	5.84	6.35
D	0.590	0.620	14.99	15.75
E	0.142	0.147	3.61	3.73
F	0.110	0.130	2.79	3.30
G	0.540	0.575	13.72	14.61
H	0.025	0.035	0.64	0.89
J	0.195	0.205	4.95	5.21
K	0.095	0.105	2.41	2.67
L	0.060	0.075	1.52	1.91
M	0.085	0.095	2.16	2.41
N	0.018	0.024	0.46	0.61
O	0.178	0.188	4.52	4.78
P	0.045	0.060	1.14	1.52
R	0.038	0.048	0.97	1.22

Dimensions — TO-263AB (N-Package) — D²Pak Surface Mount

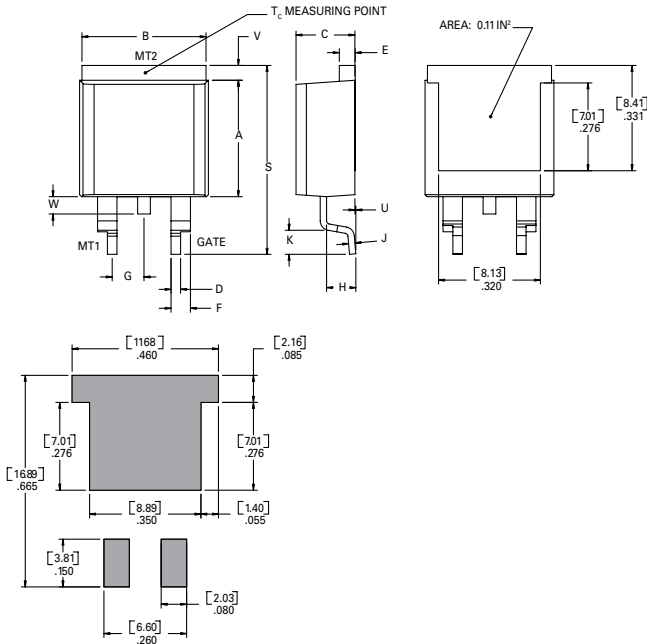

Dimension	Inches		Millimeters	
	Min	Max	Min	Max
A	0.360	0.370	9.14	9.40
B	0.380	0.420	9.65	10.67
C	0.178	0.188	4.52	4.78
D	0.025	0.035	0.64	0.89
E	0.045	0.060	1.14	1.52
F	0.060	0.075	1.52	1.91
G	0.095	0.105	2.41	2.67
H	0.092	0.102	2.34	2.59
J	0.018	0.024	0.46	0.61
K	0.090	0.110	2.29	2.79
S	0.590	0.625	14.99	15.88
V	0.035	0.045	0.89	1.14
U	0.002	0.010	0.05	0.25
W	0.040	0.070	1.02	1.78

Product Selector

Part Number	Gate Sensitivity Quadrants	Type	Package
	I – II – III		
QJxx12LH4	35 mA	Alternistor Triac	TO-220L
QJxx12RH4	35 mA	Alternistor Triac	TO-220R
QJxx12NH4	35 mA	Alternistor Triac	TO-263 D ² -PAK
QJxx12LH5	50 mA	Alternistor Triac	TO-220L
QJxx12RH5	50 mA	Alternistor Triac	TO-220R
QJxx12NH5	50 mA	Alternistor Triac	TO-263 D ² -PAK

Packing Options

Part Number	Marking	Weight	Packing Mode	Base Quantity
QJxx12RH _y TP	QJxx12RH _y	2.2 g	Tube Pack	1000 (50 per tube)
QJxx12LH _y TP	QJxx12LH _y	2.2 g	Tube Pack	1000 (50 per tube)
QJxx12NH _y TP	QJxx12NH _y	1.6 g	Tube Pack	1000 (50 per tube)
QJxx12NH _y RP	QJxx12NH _y	1.6 g	Embossed Carrier	500

Note: xx = voltage/10; y = Sensitivity

TO-263 Embossed Carrier Reel Pack (RP)

Meets all EIA-481-2 Standards

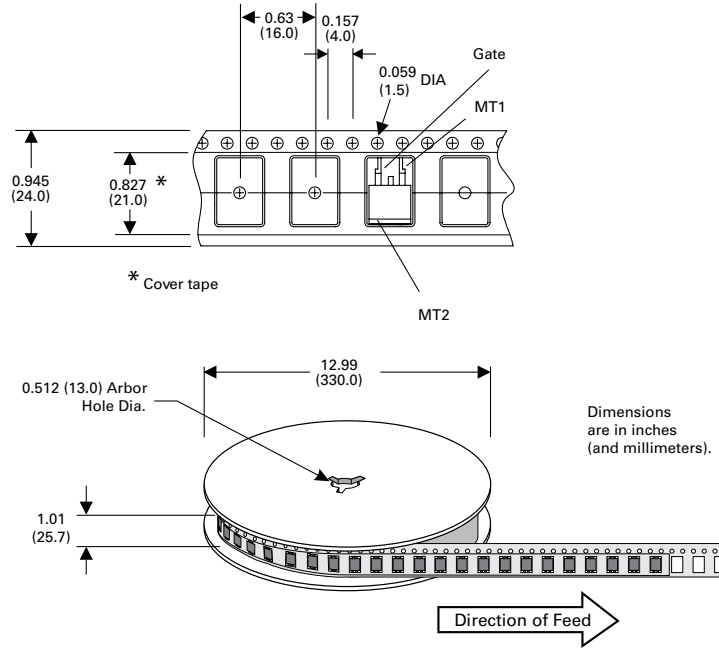

Part Numbering System

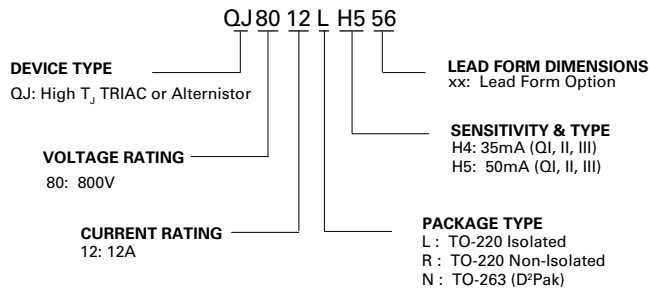

Part Marking System

TO-220 AB - (L and R Package)
 TO-263 AB - (N Package)

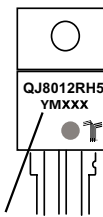

Date Code Marking
 Y: Year Code
 M: Month Code
 XXX: Lot Trace Code

Disclaimer Notice - Information furnished is believed to be accurate and reliable. However, users should independently evaluate the suitability of and test each product selected for their own applications. Littelfuse products are not designed for, and may not be used in, all applications.

Read complete Disclaimer Notice at <http://www.littelfuse.com/disclaimer-electronics>.