

Q6016xH1LED Series

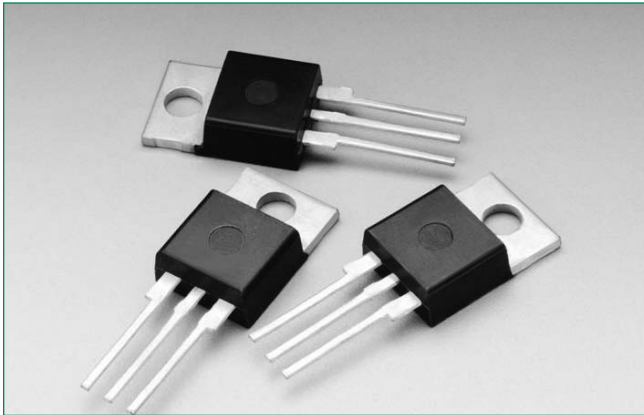

Description

Q6016LH1LED series is designed to meet low load current characteristics typical in LED lighting applications.

By keeping holding current at 5mA maximum, this Triac series is characterized and specified to perform best with LED loads. The Q6016LH1LED series is best suited for LED dimming controls to obtain the lowest levels of light output with a minimum probability of flickering.

Q6016LH1LED series is offered in the industry standard TO-220AB package with an isolated mounting tab that makes it best suited for adding an external heat sink.

Agency Recognitions

Agency	Agency File Number
	E71639

Main Features

Symbol	Value	Unit
$I_{T(RMS)}$	16	A
V_{DRM}/V_{RRM}	600	V
I_{GT}	5	mA

Features & Benefits

- As low as 5 mA max holding current
- L-Package is UL Recognized for 2500Vrms
- di/dt performance of 100A/μs
- UL Recognized to UL 1557
- Provides full control of light out put at the extreme low end of load conditions.
- 2500V_{AC} min isolation between mounting tab and active terminals
- Improves margin of safe operation with less heat sinking required
- Enable survivability of typically LED load operating characteristics
- Simplicity of circuit design & layout

Schematic Symbol

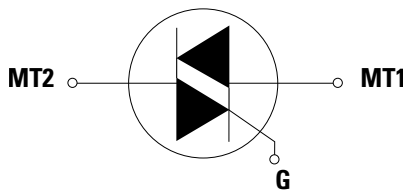

Applications

Excellent for AC switching and phase control applications such as heating, lighting, and motor speed controls.

Typical applications are AC solid-state switches, lighting controls with LED lamp loads, small low current motor in power tools, lower current motor in home/brown goods appliances.

Internally constructed isolated packages are offered for ease of heat sinking with highest isolation voltage.

Absolute Maximum Ratings

Symbol	Parameter	Value	Unit
$I_{T(RMS)}$	RMS on-state current (full sine wave)	- $T_c = 90^\circ\text{C}$	16 A
I_{TSM}	Non repetitive surge peak on-state current (full cycle, T_J initial = 25°C)	$f = 50\text{ Hz}$ $t = 20\text{ ms}$	167 A
		$f = 60\text{ Hz}$ $t = 16.7\text{ ms}$	200 A
I^2t	I^2t Value for fusing	- $t_p = 8.3\text{ ms}$	166 A^2s
di/dt	Critical rate of rise of on-state current	$f = 60\text{ Hz}$ $T_J = 125^\circ\text{C}$	100 $\text{A}/\mu\text{s}$
I_{GTM}	Peak gate trigger current	$t_p \leq 10\ \mu\text{s};$ $I_{GT} \leq I_{GTM}$ $T_J = 125^\circ\text{C}$	2.0 A
$P_{G(AV)}$	Average gate power dissipation	$T_J = 125^\circ\text{C}$	0.5 W
T_{stg}	Storage temperature range	-	-40 to 150 $^\circ\text{C}$
T_J	Operating junction temperature range	-	-40 to 125 $^\circ\text{C}$

Electrical Characteristics ($T_J = 25^\circ\text{C}$, unless otherwise specified)

Symbol	Test Conditions	Quadrant	Qxx16LH1	Unit
I_{GT}	$V_D = 12\text{ V}$ $R_L = 60\ \Omega$	I – II – III	MAX.	5 mA
V_{GT}		I – II – III	MAX.	1.3 V
V_{GD}	$V_D = V_{DRM}$ $R_L = 3.3\text{ k}\Omega$ $T_J = 125^\circ\text{C}$	I – II – III	MIN.	0.2 V
I_H	$I_T = 20\text{ mA}$		MAX.	5 mA
dv/dt	$V_D = V_{DRM}$ Gate Open $T_J = 125^\circ\text{C}$		MIN.	45 $\text{V}/\mu\text{s}$
$(dv/dt)_c$	$(di/dt)_c = 8.6\text{ A/ms}$ $T_J = 125^\circ\text{C}$		MIN.	2 $\text{V}/\mu\text{s}$
t_{gt}	$I_G = 2 \times I_{GT}$ $PW = 15\ \mu\text{s}$ $I_T = 22.6\text{ A(pk)}$		TYP.	3 μs

Static Characteristics

Symbol	Test Conditions	Value	Unit
V_{TM}	$I_{TM} = 22.6\text{ A}$ $t_p = 380\ \mu\text{s}$	MAX.	1.60 V
I_{DRM} I_{RRM}	$V_D = V_{DRM} / V_{RRM}$	$T_J = 25^\circ\text{C}$	10 μA
		$T_J = 125^\circ\text{C}$	2 mA

Thermal Resistances

Symbol	Parameter	Value	Unit
$R_{\theta(JC)}$	Junction to case (AC)	2.1	$^\circ\text{C}/\text{W}$
$R_{\theta(JA)}$	Junction to ambient	50	$^\circ\text{C}/\text{W}$

Note: xx = voltage

Figure 1: Definition of Quadrants

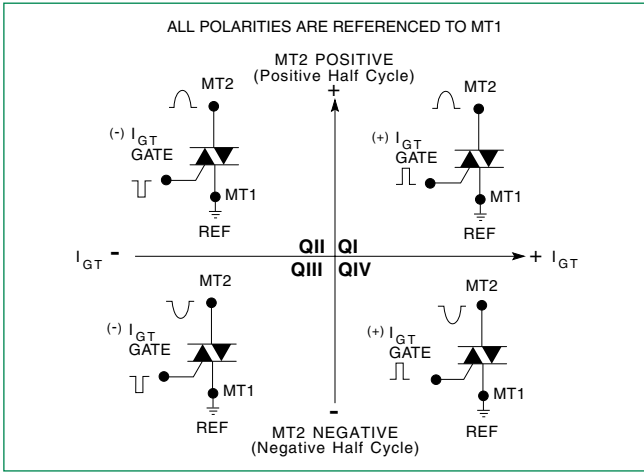

Note: Alternistors will not operate in QIV

Figure 3: Normalized DC Holding Current vs. Junction Temperature

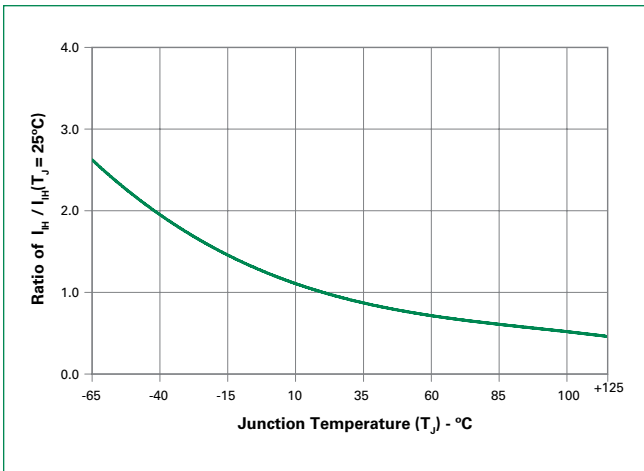

Figure 5: Power Dissipation (Typical) vs. RMS On-State Current

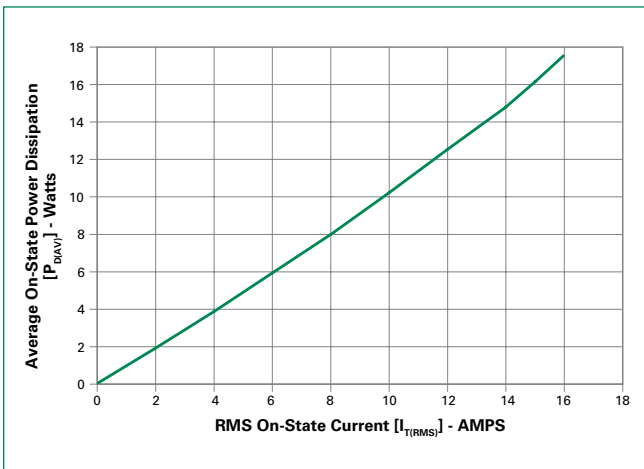

Figure 2: Normalized DC Gate Trigger Current for All Quadrants vs. Junction Temperature

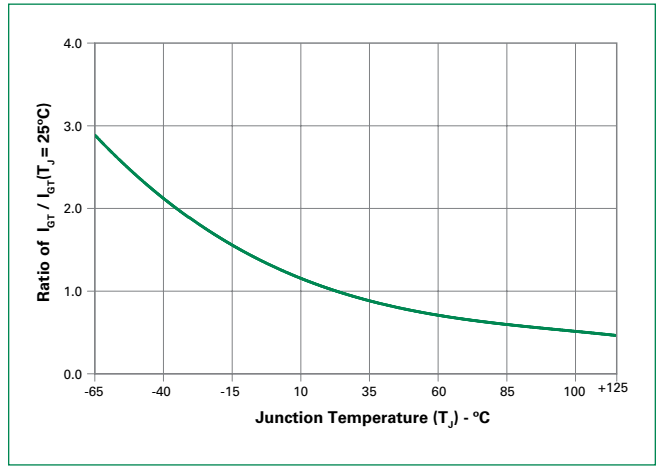

Figure 4: Normalized DC Gate Trigger Voltage for All Quadrants vs. Junction Temperature

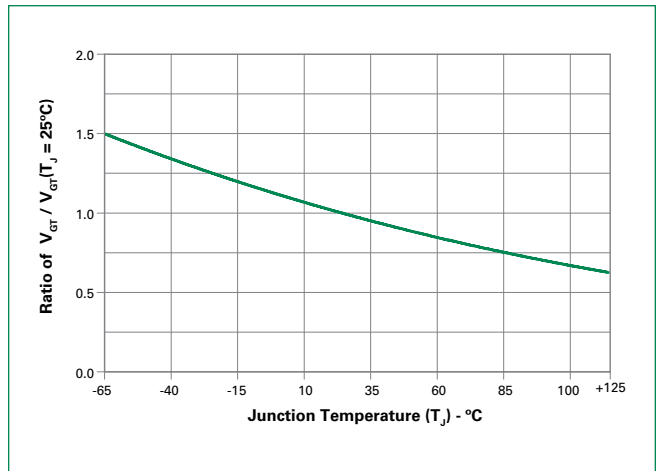

Figure 6: Maximum Allowable Case Temperature vs. On-State Current

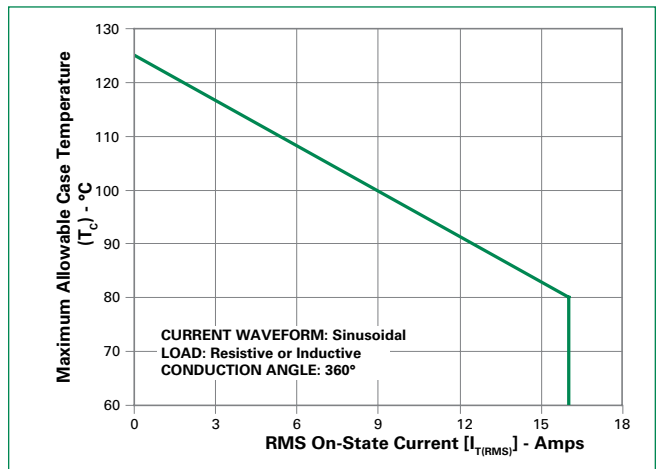

Figure 8: On-State Current vs. On-State Voltage (Typical)

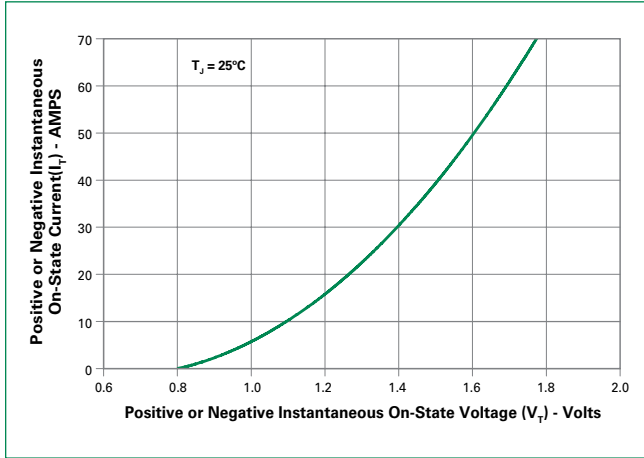
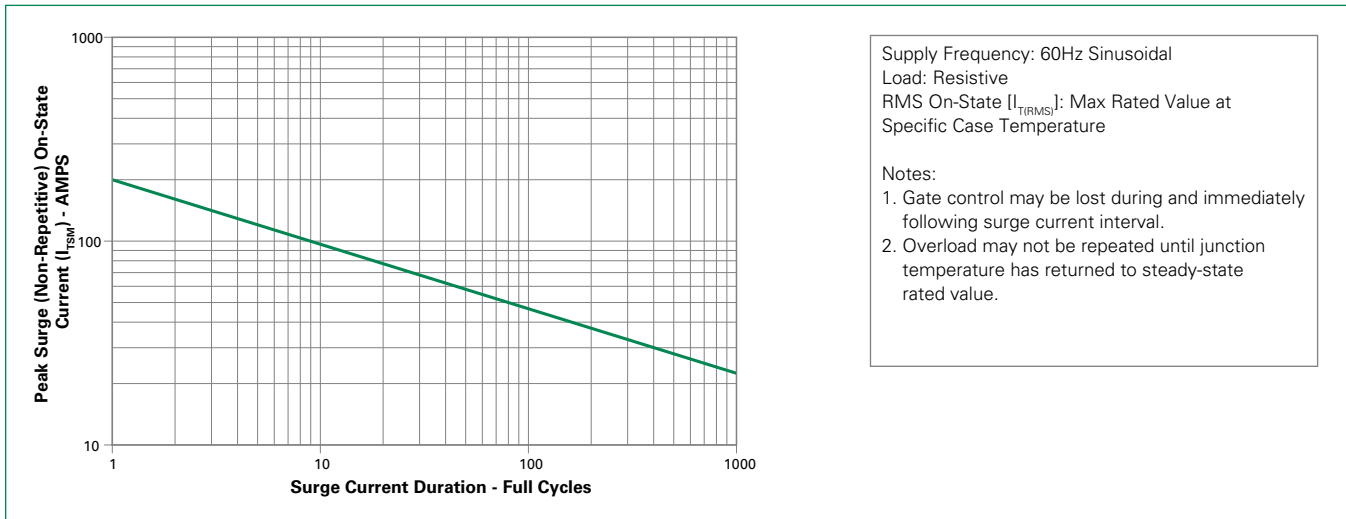
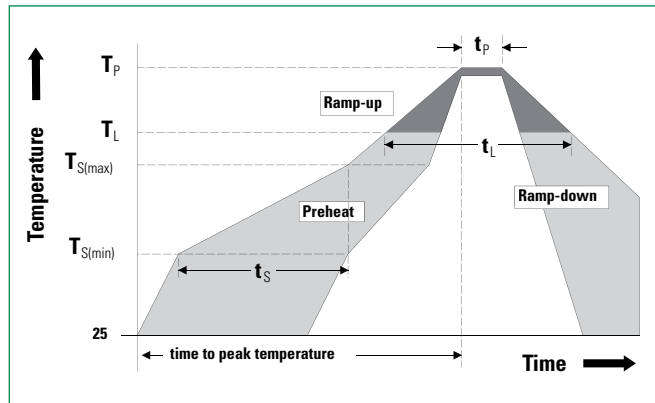

Figure 9: Surge Peak On-State Current vs. Number of Cycles



Soldering Parameters

Reflow Condition		Pb – Free assembly
Pre Heat	- Temperature Min ($T_{s(min)}$)	150°C
	- Temperature Max ($T_{s(max)}$)	200°C
	- Time (min to max) (t_s)	60 – 180 secs
Average ramp up rate (Liquidus Temp) (T_L) to peak		5°C/second max
$T_{s(max)}$ to T_L - Ramp-up Rate		5°C/second max
Reflow	- Temperature (T_L) (Liquidus)	217°C
	- Time (min to max) (t_s)	60 – 150 seconds
Peak Temperature (T_p)		260 ^{+0/-5} °C
Time within 5°C of actual peak Temperature (t_p)		20 – 40 seconds
Ramp-down Rate		5°C/second max
Time 25°C to peak Temperature (T_p)		8 minutes Max.
Do not exceed		280°C



Physical Specifications

Terminal Finish	100% Matte Tin-plated
Body Material	UL Recognized compound meeting flammability rating V-0
Terminal Material	Copper Alloy

Design Considerations

Careful selection of the correct component for the application's operating parameters and environment will go a long way toward extending the operating life of the Thyristor. Good design practice should limit the maximum continuous current through the main terminals to 75% of the component rating. Other ways to ensure long life for a power discrete semiconductor are proper heat sinking and selection of voltage ratings for worst case conditions. Overheating, overvoltage (including dv/dt), and surge currents are the main killers of semiconductors. Correct mounting, soldering, and forming of the leads also help protect against component damage.

Environmental Specifications

Test	Specifications and Conditions
AC Blocking	MIL-STD-750, M-1040, Cond A Applied Peak AC voltage @ 110°C for 1008 hours
Temperature Cycling	MIL-STD-750, M-1051, 100 cycles; -40°C to +150°C; 15-min dwell time
Temperature/Humidity	EIA / JEDEC, JESD22-A101 1008 hours; 320V - DC; 85°C; 85% rel humidity
High Temp Storage	MIL-STD-750, M-1031, 1008 hours; 150°C
Low-Temp Storage	1008 hours; -40°C
Autoclave	EIA / JEDEC, JESD22-A102 168 hours (121°C at 2 ATMs) and 100% R/H
Resistance to Solder Heat	MIL-STD-750 Method 2031
Solderability	ANSI/J-STD-002, category 3, Test A
Lead Bend	MIL-STD-750, M-2036 Cond E

Dimensions — TO-220AB (L-Package) — Isolated Mounting Tab

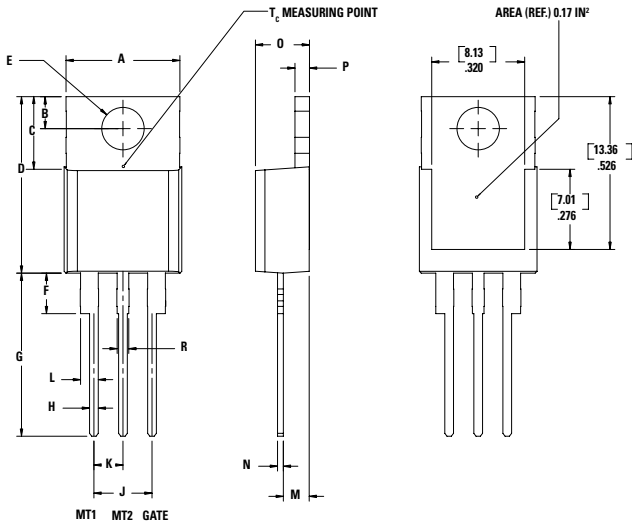

Dimension	Inches		Millimeters	
	Min	Max	Min	Max
A	0.380	0.420	9.65	10.67
B	0.105	0.115	2.67	2.92
C	0.230	0.250	5.84	6.35
D	0.590	0.620	14.99	15.75
E	0.142	0.147	3.61	3.73
F	0.110	0.130	2.79	3.30
G	0.540	0.575	13.72	14.61
H	0.025	0.035	0.64	0.89
J	0.195	0.205	4.95	5.21
K	0.095	0.105	2.41	2.67
L	0.060	0.075	1.52	1.91
M	0.085	0.095	2.16	2.41
N	0.018	0.024	0.46	0.61
O	0.178	0.188	4.52	4.78
P	0.045	0.060	1.14	1.52
R	0.038	0.048	0.97	1.22

Product Selector

Part Number	Gate Sensitivity Quadrants	Type	Package
	I - II - III		
Q6016LH1LED	5 mA	Alternistor Triac	TO-220L

Packing Options

Part Number	Marking	Weight	Packing Mode	Base Quantity
Q6016LH1LEDTP	Q6016LH1	2.2 g	Tube Pack	500 (50 per tube)

Part Numbering System

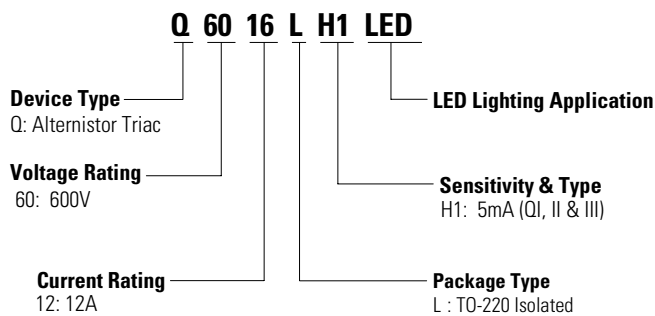

Part Marking System

TO-220 AB - (L Package)

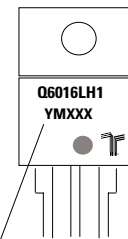

Date Code Marking
 Y: Year Code
 M: Month Code
 XXX: Lot Trace Code