

MCR72-3, MCR72-6, MCR72-8

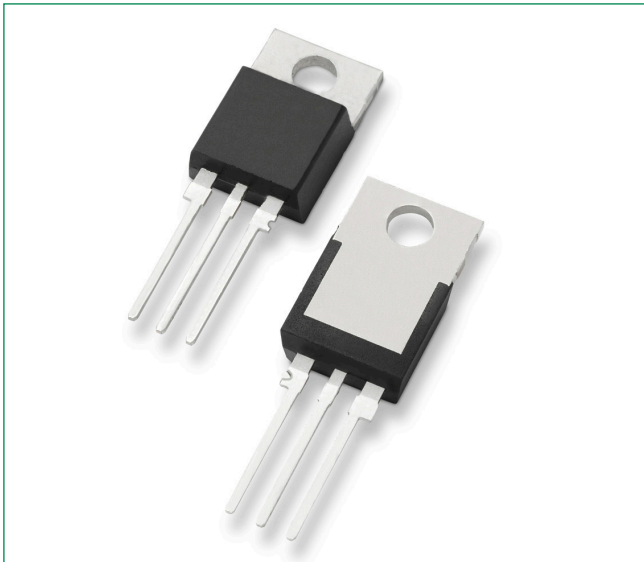

Description

Designed for industrial and consumer applications such as temperature, light and speed control; process and remote controls; warning systems; capacitive discharge circuits and MPU interface.

Features

- Center Gate Geometry for Uniform Current Density
- All Diffused and Glass-Passivated Junctions for Parameter Uniformity and Stability
- Small, Rugged Thermowatt Construction for Low Thermal Resistance, High Heat Dissipation and Durability
- Low Trigger Currents, 200 μ A Maximum for Direct Driving from Integrated Circuits
- These are Pb-Free Devices

Pin Out

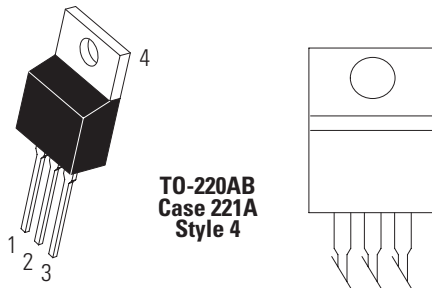

Functional Diagram



Additional Information



Datasheet



Resources



Samples

Maximum Ratings ($T_J = 25^\circ\text{C}$ unless otherwise noted)

Rating	Symbol	Value	Unit
Peak Repetitive Off-State Voltage (Note 1) (- 40 to 110°C , Sine Wave, 50 to 60 Hz, Gate Open)	MCR72-3 MCR72-6 MCR72-8 V_{DRM}^* V_{RRM}	100 400 600	V
On-State RMS Current (180° Conduction Angles; $T_C = 83^\circ\text{C}$)	$I_{T(RMS)}$	8.0	A
Peak Non-Repetitive Surge Current (1/2 Cycle, Sine Wave 60 Hz, $T_J = 110^\circ\text{C}$)	I_{TSM}	100	A
Circuit Fusing Consideration ($t = 8.3$ ms)	I^2t	40	A ² s
Forward Peak Gate Voltage (Pulse Width ≤ 10 μsec , $T_C = 83^\circ\text{C}$)	V_{GM}	± 5.0	V
Forward Peak Gate Current (Pulse Width ≤ 10 μsec , $T_C = 83^\circ\text{C}$)	I_{GM}	1.0	A
Forward Peak Gate Power (Pulse Width ≤ 10 μsec , $T_C = 83^\circ\text{C}$)	P_{GM}	5.0	W
Average Gate Power ($t = 8.3$ ms, $T_C = 83^\circ\text{C}$)	$P_{G(AV)}$	0.75	W
Operating Junction Temperature Range	T_J	-40 to +110	$^\circ\text{C}$
Storage Temperature Range	T_{stg}	-40 to +150	$^\circ\text{C}$
Mounting Torque	-	8.0	in. lb.

Stresses exceeding those listed in the Maximum Ratings table may damage the device. If any of these limits are exceeded, device functionality should not be assumed, damage may occur and reliability may be affected.

1. V_{DRM}^* and V_{RRM} for all types can be applied on a continuous basis. Ratings apply for zero or negative gate voltage; however, positive gate voltage shall not be applied concurrent with negative potential on the anode. Blocking voltages shall not be tested with a constant current source such that the voltage ratings of the devices are exceeded.

Thermal Characteristics

Characteristic	Symbol	Value	Unit
Thermal Resistance, Junction-to-Case	$R_{\theta JC}$	2.2	$^\circ\text{C/W}$
Thermal Resistance, Junction-to-Ambient	$R_{\theta JA}$	60	
Maximum Lead Temperature for Soldering Purposes, 1/8" from case for 10 seconds	T_L	260	$^\circ\text{C}$

Electrical Characteristics - OFF ($T_J = 25^\circ\text{C}$ unless otherwise noted)

Characteristic	Symbol	Min	Typ	Max	Unit	
Peak Repetitive Blocking Current ($V_{AK} = V_{DRM} = V_{RRM}$; $R_{GK} = 1\text{k}\Omega$)	I_{DRM} I_{RRM}	$T_J = 25^\circ\text{C}$	-	-	10	μA
		$T_J = 110^\circ\text{C}$	-	-	500	
High Logic Level Supply Current from V_{CC}	I_{CCH}	4	4	-		

Electrical Characteristics - ON ($T_J = 25^\circ\text{C}$ unless otherwise noted)

Characteristic	Symbol	Min	Typ	Max	Unit
Peak Forward On-State Voltage ($I_{TM} = 16$ A Peak, Pulse Width ≤ 1 ms, Duty Cycle $\leq 2\%$)	V_{TM}	-	1.7	2.0	V
Gate Trigger Current (Continuous dc) (Note 3) ($V_D = 12$ V; $R_L = 100$ Ω)	I_{GT}	-	30	200	μA
Gate Trigger Voltage (Continuous dc) (Note 3) ($V_D = 12$ V; $R_L = 100$ Ω)	V_{GT}	-	0.5	1.5	V
Gate Trigger Non-Trigger Voltage ($V_D = 12$ Vdc, $R_L = 100$ Ω , $T_J = 110^\circ\text{C}$)	V_{GD}	0.1	-	-	V
Holding Current ($V_D = 12$ V, Initiating Current = 200 mA, $R_{GK} = 1\text{k}\Omega$)	I_H	-	-	6.0	mA
Gate Controlled Turn-On Time (Note 5) ($V_D = \text{Rated } V_{DRM}$, $I_{TM} = 16$ A, $I_G = 2$ mA)	t_{gt}	-	1.0	-	μs

Dynamic Characteristics

Characteristic	Symbol	Min	Typ	Max	Unit
Critical Rate-of-Rise of Off-State Voltage ($V_D = \text{Rated } V_{DRM}$, Exponential Waveform, Gate Open, $T_J = 110^\circ\text{C}$)	dv/dt	-	10	-	V/ μs

Product parametric performance is indicated in the Electrical Characteristics for the listed test conditions, unless otherwise noted. Product performance may not be indicated by the Electrical Characteristics if operated under different conditions.

- Ratings apply for negative gate voltage or $R_{gk} = 1\text{K}\Omega$. Devices shall not have a positive gate voltage concurrently with a negative voltage on the anode. Devices should not be tested with a constant current source for forward and reverse blocking capability such that the voltage applied exceeds the rated blocking voltage.
- RGK current not included in measurement.

Voltage Current Characteristic of SCR

Symbol	Parameter
V_{DRM}	Peak Repetitive Forward Off State Voltage
I_{DRM}	Peak Forward Blocking Current
V_{RRM}	Peak Repetitive Reverse Off State Voltage
I_{RRM}	Peak Reverse Blocking Current
V_{TM}	Maximum On State Voltage
I_H	Holding Current

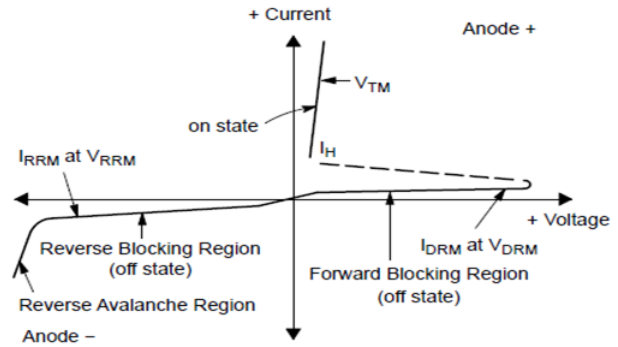

Figure 1. Average Current Derating

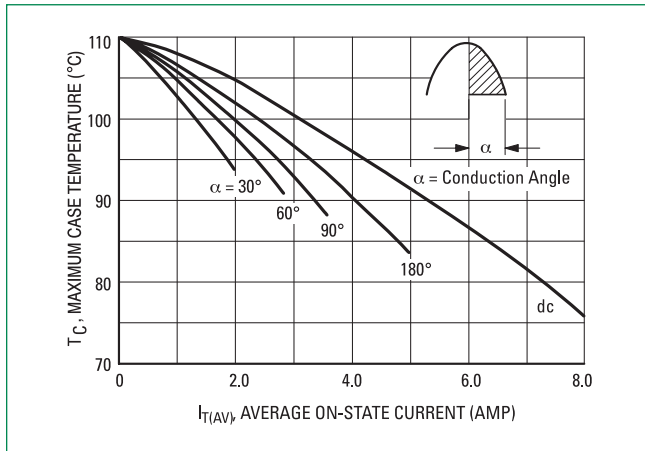

Figure 2. On-State Power Dissipation

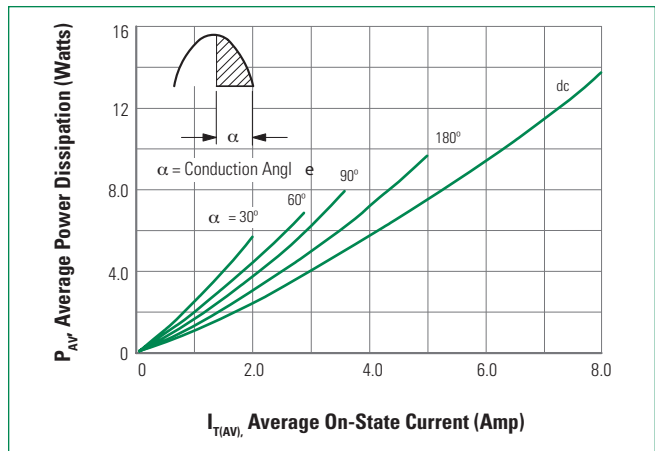

Figure 3. Normalized Gate Current

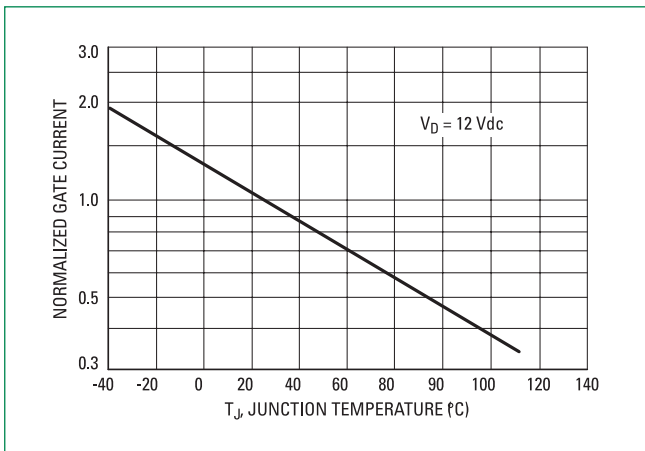
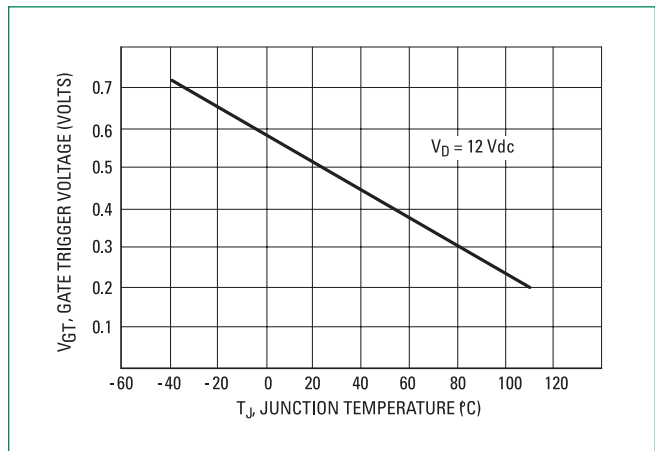
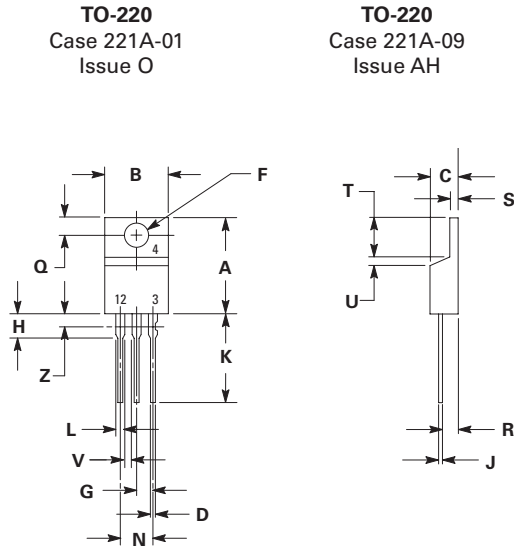

Figure 4. Gate Voltage



Dimensions



Part Marking System

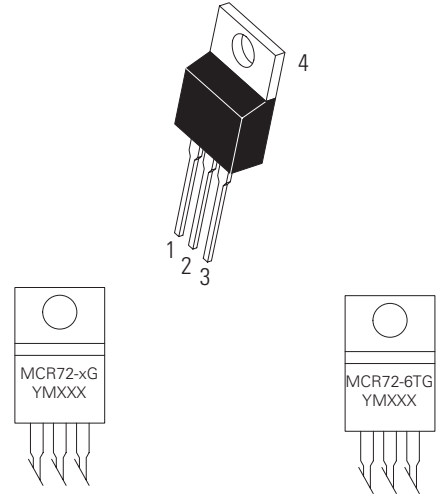

MCR72-x = Device Code
 Y = Year
 M = Month
 XXX = Lot Trace Code
 G = Pb-Free Package

MCR72-6T = Device Code
 Y = Year
 M = Month
 XXX = Lot Trace Code
 G = Pb-Free Package

Dim	Inches		Millimeters	
	Min	Max	Min	Max
A	0.590	0.620	14.99	15.75
B	0.380	0.420	9.65	10.67
C	0.178	0.188	4.52	4.78
D	0.025	0.035	0.64	0.89
F	0.142	0.147	3.61	3.73
G	0.095	0.105	2.41	2.67
H	0.110	0.130	2.79	3.30
J	0.018	0.024	0.46	0.61
K	0.540	0.575	13.72	14.61
L	0.060	0.075	1.52	1.91
N	0.195	0.205	4.95	5.21
Q	0.105	0.115	2.67	2.92
R	0.085	0.095	2.16	2.41
S	0.045	0.060	1.14	1.52
T	0.235	0.255	5.97	6.47
U	0.000	0.050	0.00	1.27
V	0.045	—	1.15	—
Z	—	0.080	—	2.04

Pin Assignment	
1	Cathode
2	Anode
3	Gate
4	Anode

Ordering Information		
Device	Package	Shipping
MCR72-3G	TO-220AB (Pb-Free)	1000 Units / Box
MCR72-6G		
MCR72-6TG		
MCR72-8G		
MCR72-8TG		

1. DIMENSIONING AND TOLERANCING PER ANSI Y14.5M, 1982.
 2. CONTROLLING DIMENSION: INCH.
 3. DIMENSION Z DEFINES A ZONE WHERE ALL BODY AND LEAD IRREGULARITIES ARE ALLOWED.