

# MAC4DLM

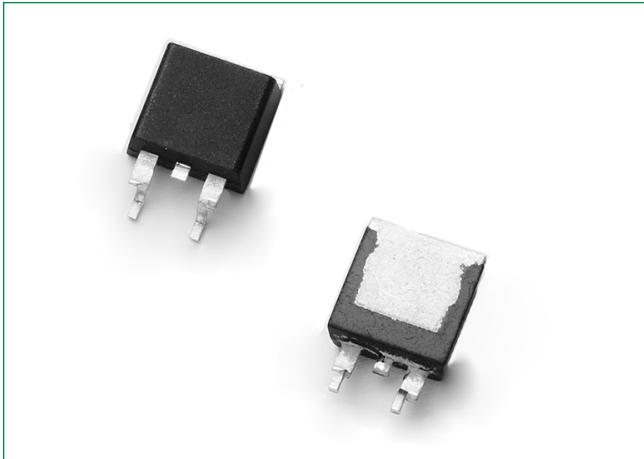

## Description

The MAC4DLM is designed for high volume, low cost, industrial and consumer applications such as motor control, process control, temperature, light and speed control.

## Features

- Small Size Surface Mount DPAK Package
- Passivated Die for Reliability and Uniformity
- Four-Quadrant Triggering
- Blocking Voltage to 600 V
- On-State Current Rating of 4.0 A RMS at 93°C
- Low Level Triggering and Holding Characteristics
- Epoxy Meets UL 94 V-0 @ 0.125 in
- ESD Ratings: Human Body Model, 3B > 8000 V  
Machine Model, C > 400V
- Lead-Free Packages are Available

## Pin Out

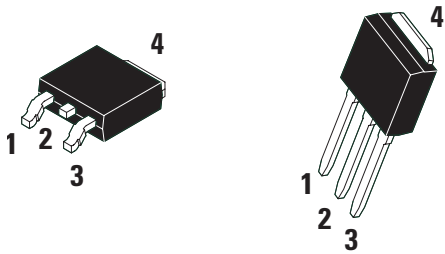

## Functional Diagram

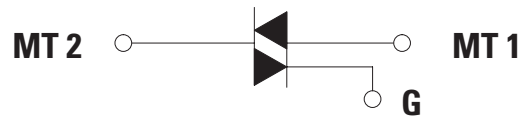

### Maximum Ratings ( $T_J = 25^\circ\text{C}$ unless otherwise noted)

Rating	Symbol	Value	Unit
Peak Repetitive Off-State Voltage (Note 1) (Gate Open, Sine Wave 50 to 60 Hz, $T_J = -40^\circ$ to $110^\circ\text{C}$ )	$V_{DRM}^*$ $V_{RRM}$	600	V
On-State RMS Current (Full Cycle Sine Wave, 60 Hz, $T_C = 93^\circ\text{C}$ )	$I_T$ (RMS)	4.0	A
Peak Non-Repetitive Surge Current (One Full Cycle Sine Wave, 60 Hz, $T_C = 110^\circ\text{C}$ )	$I_{TSM}$	40	A
Circuit Fusing Consideration ( $t = 8.3$ msec)	$I^2t$	6.6	A <sup>2</sup> sec
Peak Gate Current (Pulse Width $\leq 20$ $\mu\text{sec}$ , $T_C = 93^\circ\text{C}$ )	$I_{GM}$	4.0	A
Peak Gate Power (Pulse Width $\leq 10$ $\mu\text{sec}$ , $T_C = 93^\circ\text{C}$ )	$P_{GM}$	2.0	W
Peak Gate Voltage (Pulse Width $\leq 20$ $\mu\text{sec}$ , $T_C = 93^\circ\text{C}$ )	$V_{GM}$	5.0	V
Average Gate Power ( $t = 8.3$ msec, $T_C = 108^\circ\text{C}$ )	$P_{G(AV)}$	1.0	W
Operating Junction Temperature Range	$T_J$	-40 to +110	$^\circ\text{C}$
Storage Temperature Range	$T_{stg}$	-40 to +150	$^\circ\text{C}$

Stresses exceeding Maximum Ratings may damage the device. Maximum Ratings are stress ratings only. Functional operation above the Recommended Operating Conditions is not implied. Extended exposure to stresses above the Recommended Operating Conditions may affect device reliability.

1.  $V_{DRM}$  and  $V_{RRM}$  for all types can be applied on a continuous basis. Ratings apply for zero or negative gate voltage; however, positive gate voltage shall not be applied concurrent with negative potential on the anode. Blocking voltages shall not be tested with a constant current source such that the voltage ratings of the devices are exceeded.

### Thermal Characteristics

Rating	Symbol	Value	Unit
Thermal Resistance, Junction-to-Case (AC) Junction-to-Ambient Junction-to-Ambient (Note 2)	$R_{\theta JC}$ $R_{\theta JA}$ $R_{\theta JA}$	3.5 88 80	$^\circ\text{C}/\text{W}$
Maximum Lead Temperature for Soldering Purposes, 1/8" from case for 10 seconds	$T_L$	260	$^\circ\text{C}$

2. These ratings are applicable when surface mounted on the minimum pad sizes recommended.

3. 1/8" from case for 10 seconds.

### Electrical Characteristics - OFF ( $T_J = 25^\circ\text{C}$ unless otherwise noted ; Electricals apply in both directions)

Characteristic	Symbol	Min	Typ	Max	Unit
Peak Repetitive Blocking Current ( $V_D = V_{DRM} = V_{RRM}$ , Gate Open)	$I_{DRM}^*$ $I_{RRM}$	-	-	0.01	mA
		-	-	2.0	

### Electrical Characteristics - ON ( $T_J = 25^\circ\text{C}$ unless otherwise noted; Electricals apply in both directions)

Characteristic	Symbol	Min	Typ	Max	Unit
Peak On-State Voltage (Note 4) ( $I_{TM} = \pm 6.0$ A)	$V_{TM}$	-	1.3	1.6	V
Gate Trigger Current (Continuous dc) ( $V_D = 12$ V, $R_L = 100$ $\Omega$ )	MT2(+), G(+)	-	1.8	3.0	mA
	MT2(+), G(-)	-	2.1	3.0	
	MT2(-), G(-)	-	2.4	3.0	
	MT2(-), G(+)	-	4.2	5.0	
Holding Current ( $V_D = 12$ V, Gate Open, Initiating Current = $\pm 200$ mA)	$I_H$	-	1.5	15	mA
Gate Non-Trigger Voltage (Continuous dc) – ( $V_D = 12$ V, $R_L = 100$ $\Omega$ , $T_J = 110^\circ\text{C}$ ) All Four Quadrants	$V_{GD}$	0.1	0.4	-	V
Latching Current	( $V_D = 12$ V, $I_G = 5.0$ mA) MT2(+), G(+)	-	1.75	10	mA
	( $V_D = 12$ V, $I_G = 5.0$ mA) MT2(+), G(-)	-	5.2	10	
	( $V_D = 12$ V, $I_G = 5.0$ mA) MT2(-), G(-)	-	2.1	10	
	( $V_D = 12$ V, $I_G = 10$ mA) MT2(-), G(+)	-	2.2	10	
Gate Trigger Voltage (Continuous dc) ( $V_D = 12$ V, $R_L = 100$ $\Omega$ )	MT2(+), G(+)	0.5	0.62	1.3	V
	MT2(+), G(-)	0.5	0.57	1.3	
	MT2(-), G(-)	0.5	0.65	1.3	
	MT2(-), G(+)	0.5	0.74	1.3	

4. Indicates Pulse Test: Pulse Width  $\leq 2.0$  ms, Duty Cycle  $\leq 2\%$ .

**Dynamic Characteristics**

Characteristic	Symbol	Min	Typ	Max	Unit
Rate of Change of Commutating Current ( $V_D = 200V, I_{TM} = 1.8A$ , Commutating $dv/dt = 1.0V/\mu\text{sec}$ , $T_J = 110^\circ\text{C}$ , $f = 250\text{ Hz}$ , $CL = 5.0\ \mu\text{fd}$ , $LL = 80\text{ mH}$ , $RS = 56\ \Omega$ , $CS = 0.03\ \mu\text{fd}$ ) With snubber see Figure 11	(di/dt)c	-	3.0	-	A/ms
Critical Rate of Rise of Off-State Voltage ( $V_D = 0.67 \times V_{DRM}$ , Exponential Waveform, Gate Open, $T_J = 110^\circ\text{C}$ )	dV/dt	10	-	-	V/ $\mu\text{s}$

**Voltage Current Characteristic of SCR**

Symbol	Parameter
$V_{DRM}$	Peak Repetitive Forward Off State Voltage
$I_{DRM}$	Peak Forward Blocking Current
$V_{RRM}$	Peak Repetitive Reverse Off State Voltage
$I_{RRM}$	Peak Reverse Blocking Current
$V_{TM}$	Maximum On State Voltage
$I_H$	Holding Current

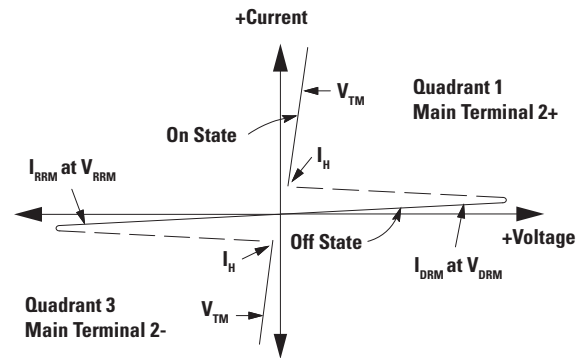

**Quadrant Definitions for a Triac**

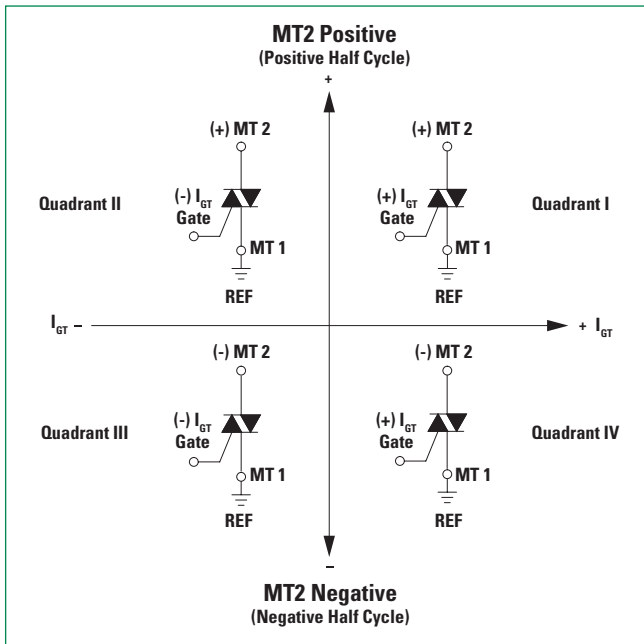

All Polarities are referenced to MT1.  
With in-phase signals (using standard AC lines) quadrants I and III are used

**Figure 1. Typical RMS Current Derating**

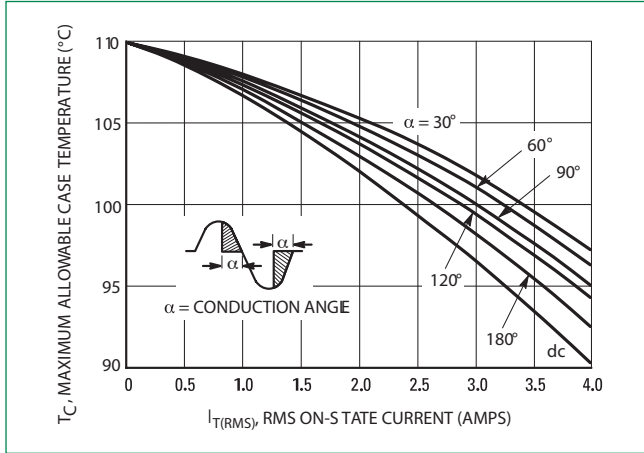

**Figure 2. On-State Power Dissipation**

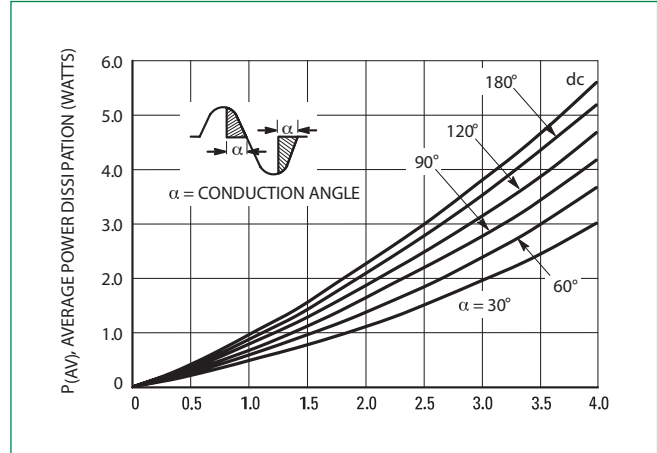

**Figure 3. On-State Characteristics**

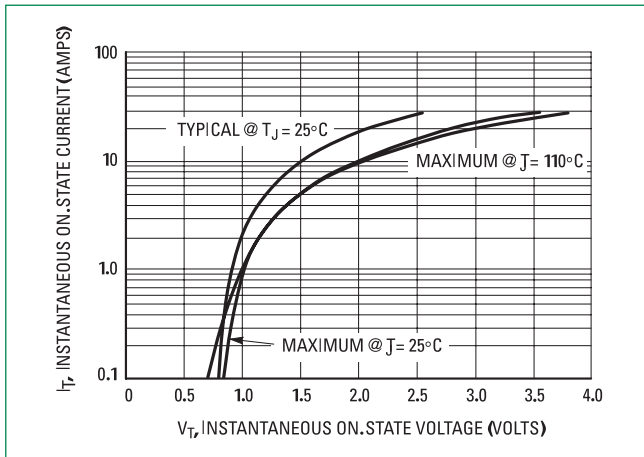

**Figure 4. Transient Thermal Response**

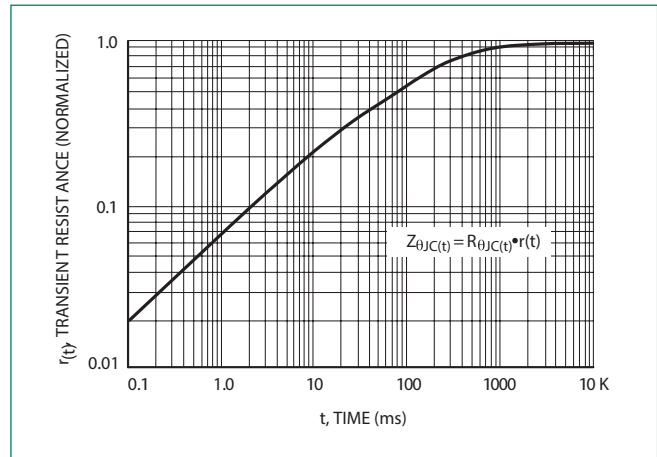

**Figure 5. Typical Gate Trigger Current vs. Junction Temperature**

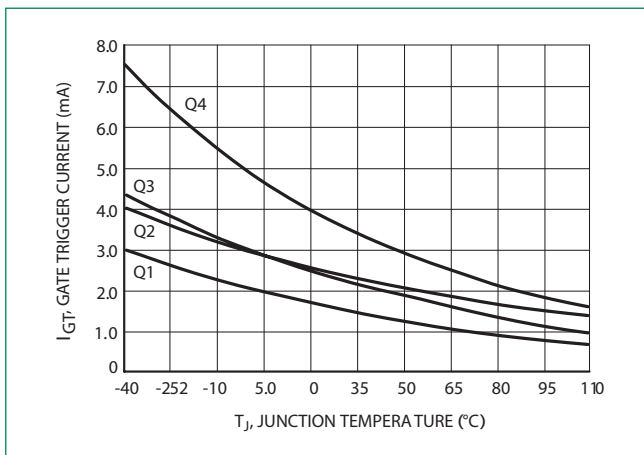

**Figure 6. Typical Gate Trigger Voltage vs. Junction Temperature**

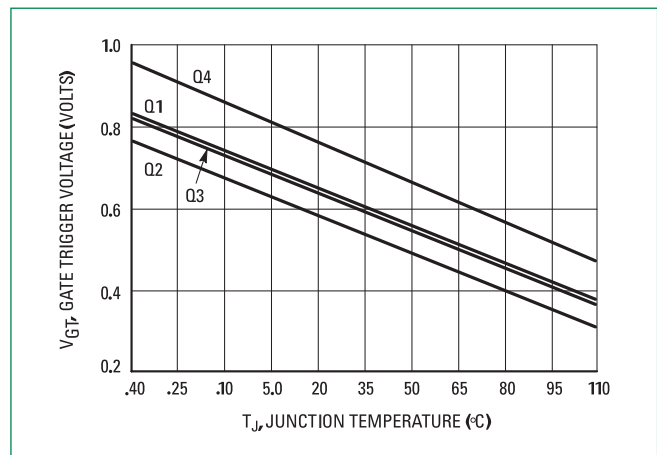

**Figure 7. Typical Holding Current vs. Junction Temperature**

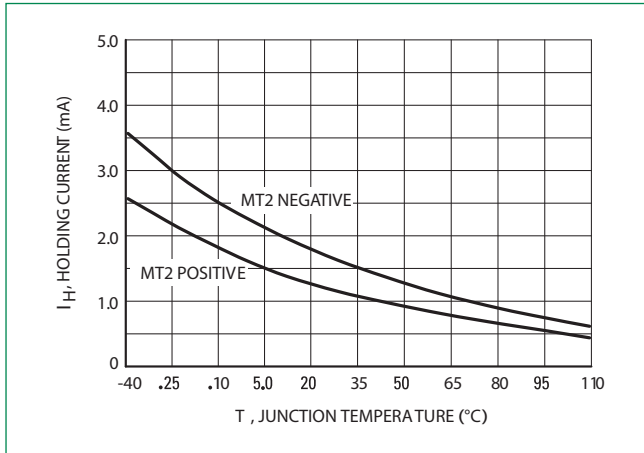

**Figure 8. Typical Latching Current vs. Junction Temperature**

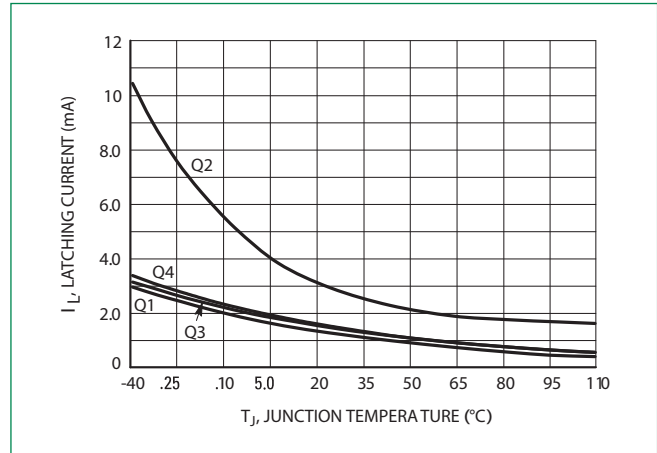

**Figure 9. Exponential Static dv/dt vs. Gate-MT1 Resistance, MT2(+)**

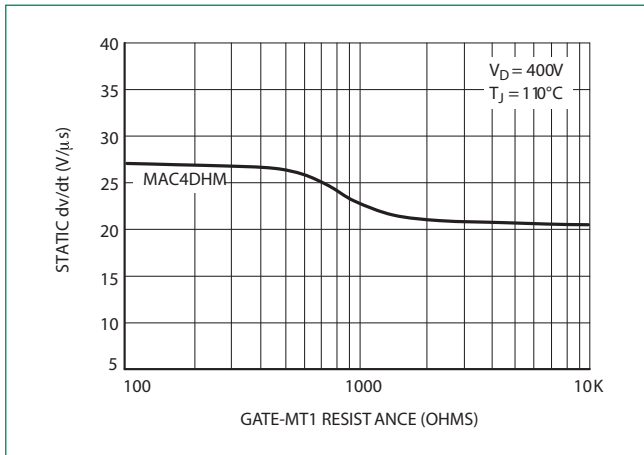

**Figure 10. Exponential Static dv/dt vs. Gate-MT1 Resistance, MT2(-)**

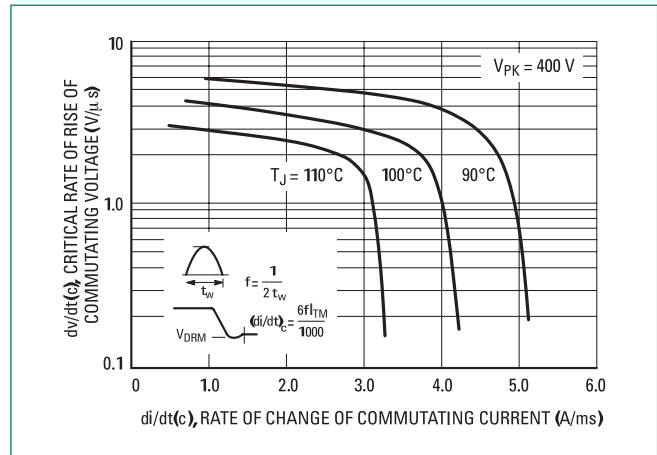

**Figure 11. Simplified Test Circuit to Measure the Critical Rate of Rise of Commutating Current (di/dt)**

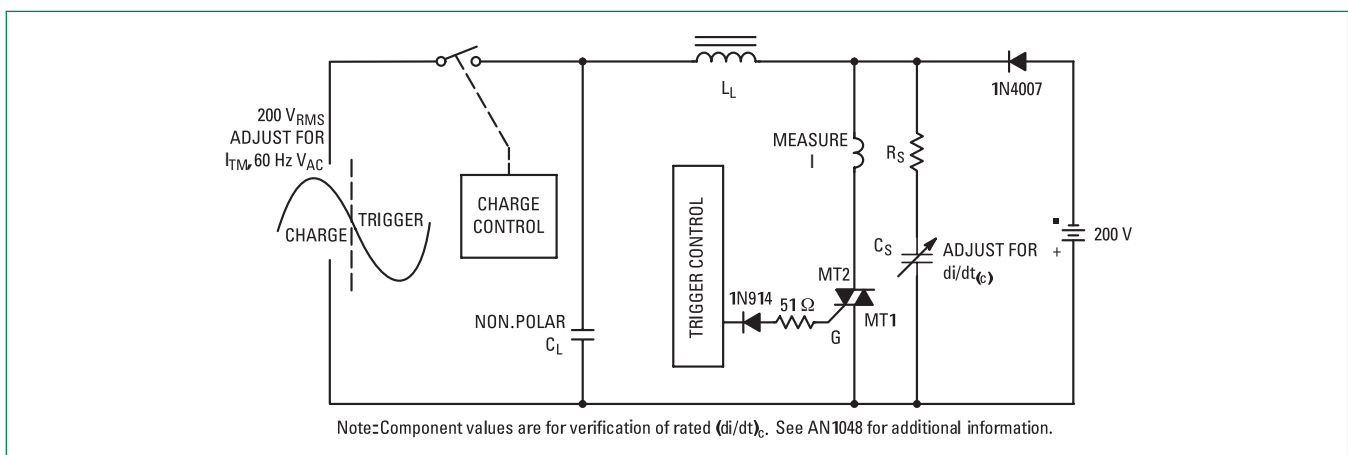

**Dimensions**

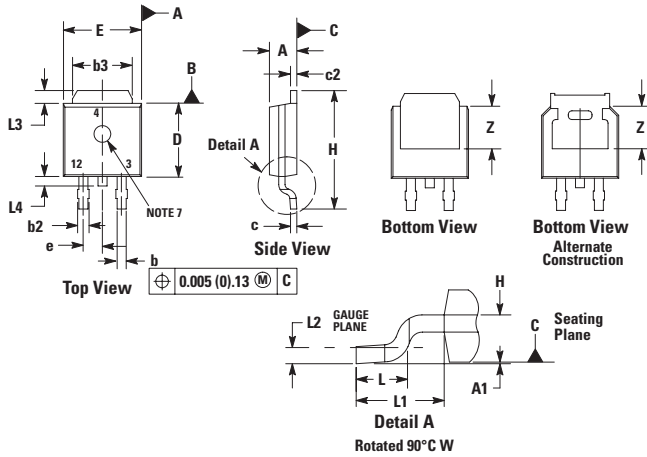

**Soldering Footprint**

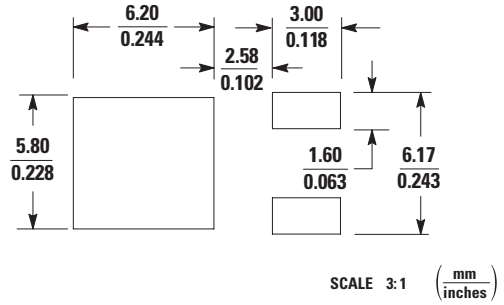

Dim	Inches		Millimeters	
	Min	Max	Min	Max
A	0.087	0.094	2.20	2.40
A1	0.000	0.005	0.00	0.12
b	0.022	0.030	0.55	0.75
b2	0.026	0.033	0.65	0.85
b3	0.209	0.217	5.30	5.50
c	0.019	0.023	0.49	0.59
c2	0.019	0.023	0.49	0.59
D	0.213	0.224	5.40	5.70
E	0.252	0.260	6.40	6.60
e	0.091		2.30	
H	0.374	0.406	9.50	10.30
L	0.058	0.070	1.47	1.78
L1	0.114		2.90	
L2	0.019	0.023	0.49	0.59
L3	0.053	0.065	1.35	1.65
L4	0.028	0.039	0.70	1.00
Z	0.154	-	3.90	-

1. Dimensioning and tolerancing per ansi y14.5m, 1982.
2. Controlling Dimension: Inch, Style 6; Pin 1, MT1
3. MT2
4. Gate
5. MT2

### Dimensions

**DPAK-3**  
Case 369D  
**T0251-3L POD**

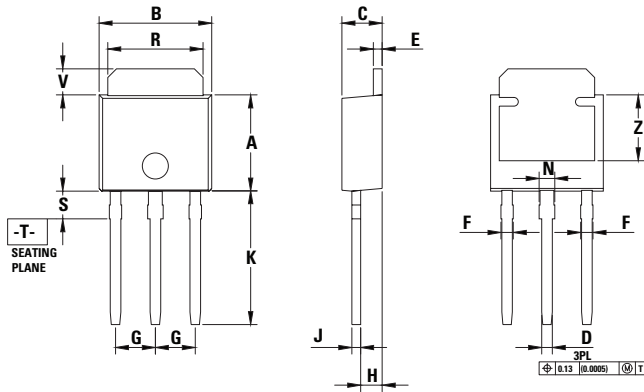

Dim	Inches		Millimeters	
	Min	Max	Min	Max
A	0.213	0.224	5.40	5.70
B	0.252	0.260	6.40	6.60
C	0.087	0.094	2.20	2.40
D	0.024	0.030	0.60	0.75
E	0.022	0.026	0.55	0.65
F	0.022	0.03	0.58	0.78
G	0.091		2.30	
H	0.046	0.050	1.18	1.28
J	0.019	0.023	0.49	0.59
K	0.291	0.315	7.40	8.00
N	0.030	0.038	0.78	0.98
R	0.209	0.217	5.30	5.50
S	0.063		1.60	
V	0.053	0.065	1.35	1.65
Z	0.150		3.80	

1. Dimensioning and Tolerancing Per ANSI Y14.5M, 1982.
2. Controlling Dimension: Inch.  
STYLE 6: Pin 1. MT1
2. MT2
3. Gate
4. MT2

### Part Marking System

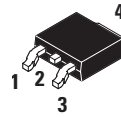

**DPAK-3**  
Case 369C  
Style 6

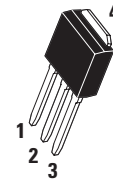
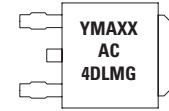

**DPAK-3**  
Case 369D  
Style 6

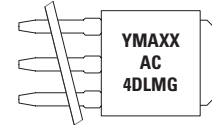

AC4DCx = Device Code  
x = D, M, or N  
Y = Year  
M = Month  
A = Assembly Site  
XX = Lot Serial Code  
G = Pb-Free Package

### Pin Assignment

Pin	Assignment
1	Main Terminal 1
2	Main Terminal 2
3	Gate
4	Main Terminal 2

### Ordering Information

Device	Package Type	Package	Shipping
MAC4DLM-001	DPAK-3	369D	4000 Units / Box
MAC4DLM-001G	DPAK-3 (Pb-Free)	369D	4000 Units / Box
MAC4DLMT4	DPAK-3	369C	2500 / Tape & Reel
MAC4DLMT4G	DPAK-3 (Pb-Free)	369C	2500 / Tape & Reel