

SIDACtor® Primary Protection Series - Modified TO-220

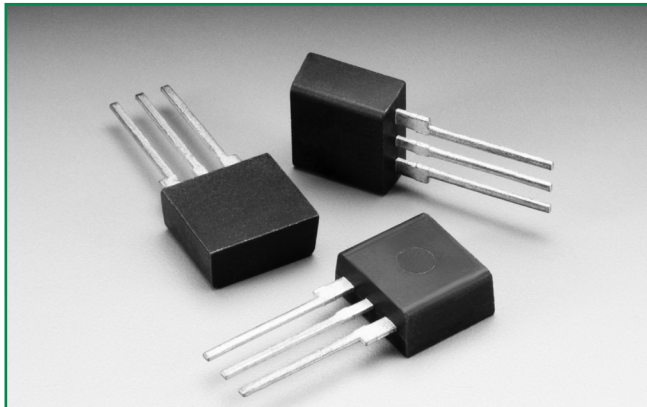

Description

The SIDACtor® Primary Protection Series Modified TO-220 thyristors are components designed for use in primary protection applications.

The series provides a single port overvoltage solution that enables applications to comply with GR-974 and a range of other global regulatory standards. Please contact Littelfuse to discuss your particular application and regulatory requirements.

Features and Benefits

- High holding current options available
- Failsafe option available
- Low voltage overshoot
- Low on-state voltage
- Does not degrade surge capability after multiple surge events within limit.
- RoHS Compliant and Halogen-Free
- Fails short circuit
- when surged in excess of ratings
- Single-port protection
- Modified TO-220 Package
- Lead forms available
- Pb-free E3 means 2nd level interconnect is Pb-free and the terminal finish material is tin(Sn) (IPC/JEDEC J-STD-609A.01)

Agency Approvals

Agency	Agency File Number
	E133083

Pinout Designation

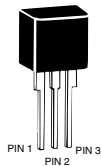

Schematic Symbol

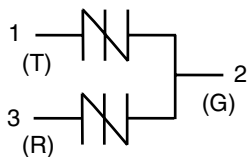

Applicable Global Standards

- GR-974
- UL 497
- ITU K.28

Electrical Characteristics

Part Number	Marking	V_{DRM} @ $I_{DRM} = 5\mu A$		V_S @ $100V/\mu s$		V_{DRM} @ $I_{DRM} = 5\mu A$	V_S @ $100V/\mu s$	V_T @ $I_T = 2.2 A$	I_H^*	I_S	I_T	Capacitance @ 1MHz, 2V bias	
		V min	V max	V min	V max	V max	mA min	mA max	A max	pF min	pF max		
		Pins 1-2, 3-2		Pins 1-3		Pins 1-2, 3-2							
P0602ACLxx	P0602AC	25	40	50	80	4	50	800	2.2	See Capacitance Values Table			
P1402ACLxx	P1402AC	58	77	116	154	4	150	800	2.2				
P1602ACLxx	P1602AC	65	95	130	190	4	150	800	2.2				
P2202ACLxx	P2202AC	90	130	180	260	4	150	800	2.2				
P2702ACLxx	P2702AC	120	160	240	320	4	150	800	2.2				
P3002ACLxx	P3002AC	140	180	280	360	4	150	800	2.2				
P3602ACLxx	P3602AC	170	220	340	440	4	150	800	2.2				
P4202ACLxx	P4202AC	190	250	380	500	4	150	800	2.2				
P4802ACLxx	P4802AC	220	300	440	600	4	150	800	2.2				
P6002ACLxx	P6002AC	275	350	550	700	4	150	800	2.2				

Notes:
 * Higher holding current available by special order. Contact Littelfuse for additional information. - **xx** Part Number Suffix: '**RP**' (Reel pack), **Blank** (Bulk pack), '**60**' (Type 60 lead form bulk pack),
 - Absolute maximum ratings measured at $T_c = 25^\circ C$ (unless otherwise noted).
 - Devices are bi-directional (unless otherwise noted).
 - '**FS1**' (Failsafe option bulk pack). Refer to Part Numbering section for additional details.

Surge Ratings

Series	I_{PP}										I_{TSM} 50/60 Hz	di/dt
	0.2x310 ¹	2x10 ¹	8x20 ¹	10x160 ¹	10x560 ¹	5x320 ¹	10x360 ¹	10x1000 ¹	5x310 ¹	10x700 ²		
	0.5x700 ²	2x10 ²	1.2x50 ²	10x160 ²	10x560 ²	9x720 ²	10x360 ²	10x1000 ²	10x700 ²	10x700 ²		
	A min	A min	A min	A min	A min	A min	A min	A min	A min	A min	A min	A/μs min
C	50	500	400	200	150	200	175	100	200	50	500	

Notes:

- 1 Current waveform in μs
- 2 Voltage waveform in μs
- Peak pulse current rating (I_{PP}) is repetitive and guaranteed for the life of the product.
- I_{PP} ratings applicable over temperature range of -40°C to +85°C
- The device must initially be in thermal equilibrium with -40°C ≤ T_J ≤ +150°C

Capacitance Values

Part Number	Pin 1-2 / 3-2 Tip-Ground, Ring-Ground		Pin 1-3 Tip-Ring	
	pF min	pF max	pF min	pF max
P0602ACLxx	35	65	20	40
P1402ACLxx	105	155	60	90
P1602ACLxx	95	145	50	85
P2202ACLxx	75	115	40	65
P2702ACLxx	70	105	40	60
P3002ACLxx	65	95	35	55
P3602ACLxx	65	90	35	50
P4202ACLxx	60	85	35	50
P4802ACLxx	60	85	30	50
P6002ACLxx	55	80	30	45

Note: Off-state capacitance (C_O) is measured at 1 MHz with a 2 V bias.

$t_r \times t_d$ Pulse Waveform

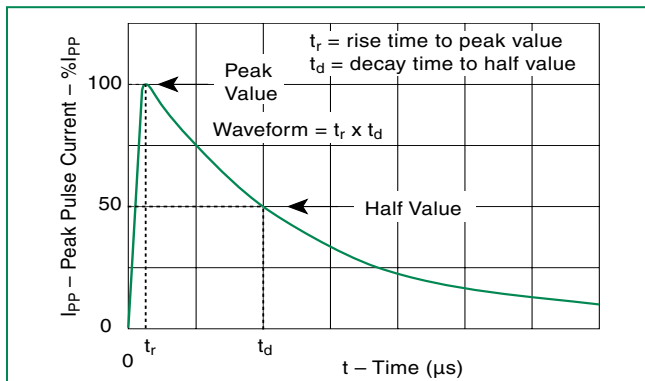

Thermal Considerations

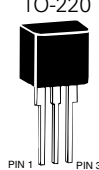
Package	Symbol	Parameter	Value	Unit
Modified TO-220 	T_J	Operating Junction Temperature Range	-40 to +150	°C
	T_S	Storage Temperature Range	-65 to +150	°C
	$R_{\theta JA}$	Thermal Resistance: Junction to Ambient	60	°C/W

V-I Characteristics

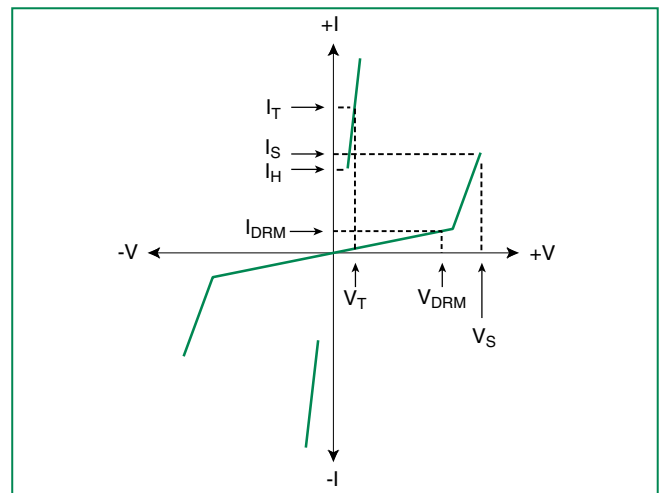

Normalized V_S Change vs. Junction Temperature

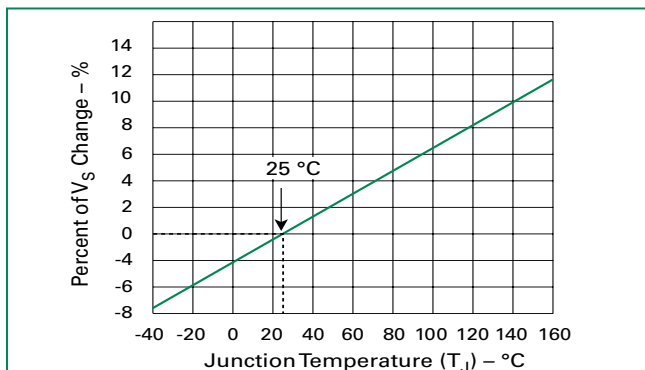

Normalized DC Holding Current vs. Case Temperature

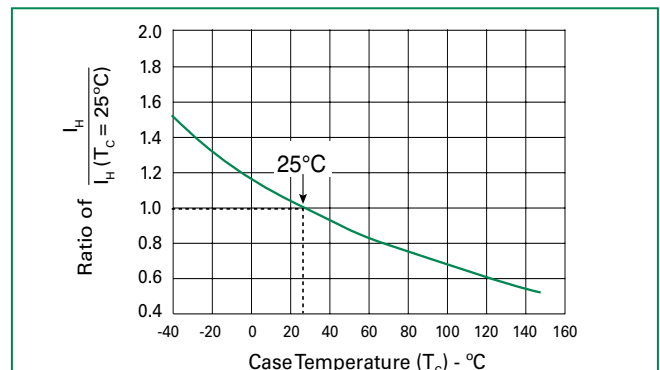

Soldering Parameters

Reflow Condition		Pb-Free assembly (see Fig. 1)
Pre Heat	- Temperature Min ($T_{s(min)}$)	+150°C
	- Temperature Max ($T_{s(max)}$)	+200°C
	- Time (Min to Max) (t_s)	60-180 secs.
Average ramp up rate (Liquidus Temp (T_L) to peak)		3°C/sec. Max.
$T_{s(max)}$ to T_L - Ramp-up Rate		3°C/sec. Max.
Reflow	- Temperature (T_L) (Liquidus)	+217°C
	- Temperature (t_L)	60-150 secs.
Peak Temp (T_p)		+260(+0/-5)°C
Time within 5°C of actual Peak Temp (t_p)		30 secs. Max.
Ramp-down Rate		6°C/sec. Max.
Time 25°C to Peak Temp (T_p)		8 min. Max.
Do not exceed		+260°C

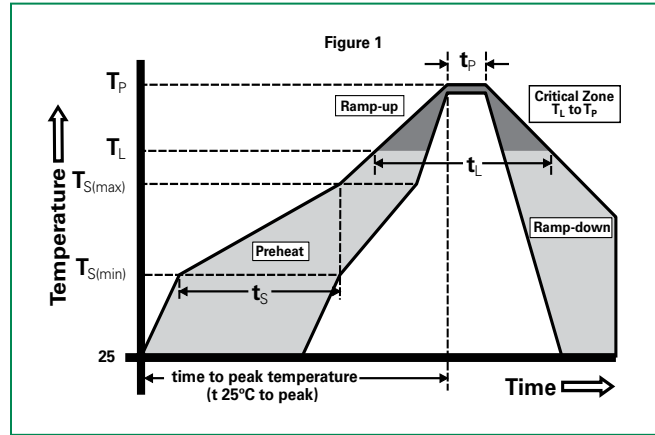

Physical Specifications

Lead Material	Copper Alloy
Terminal Finish	100% Matte-Tin Plated
Body Material	UL Recognized epoxy meeting flammability classification V-0

Environmental Specifications

High Temp Voltage Blocking	80% Rated V_{DRM} (V_{AC} Peak) +125°C or +150°C, 504 or 1008 hrs. MIL-STD-750 (Method 1040) JEDEC, JESD22-A-101
Temp Cycling	-65°C to +150°C, 15 min. dwell, 10 up to 100 cycles. MIL-STD-750 (Method 1051) EIA/JEDEC, JESD22-A104
Biased Temp & Humidity	52 V_{DC} (+85°C) 85%RH, 504 up to 1008 hrs. EIA/JEDEC, JESD22-A-101
High Temp Storage	+150°C 1008 hrs. MIL-STD-750 (Method 1031) JEDEC, JESD22-A-101
Low Temp Storage	-65°C, 1008 hrs.
Thermal Shock	0°C to +100°C, 5 min. dwell, 10 sec. transfer, 10 cycles. MIL-STD-750 (Method 1056) JEDEC, JESD22-A-106
Autoclave (Pressure Cooker Test)	+121°C, 100%RH, 2atm, 24 up to 168 hrs. EIA/JEDEC, JESD22-A-102
Resistance to Solder Heat	+260°C, 30 secs. MIL-STD-750 (Method 2031)
Moisture Sensitivity Level	85%RH, +85°C, 168 hrs., 3 reflow cycles (+260°C Peak). JEDEC-J-STD-020, Level 1

Part Numbering

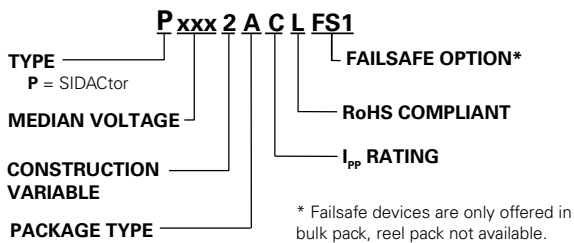
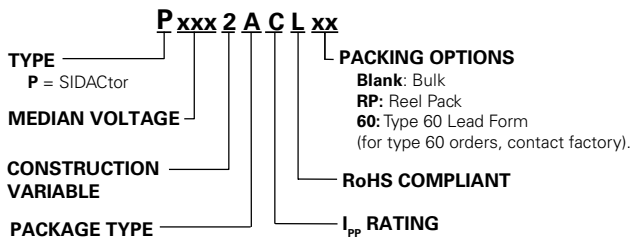

Part Marking

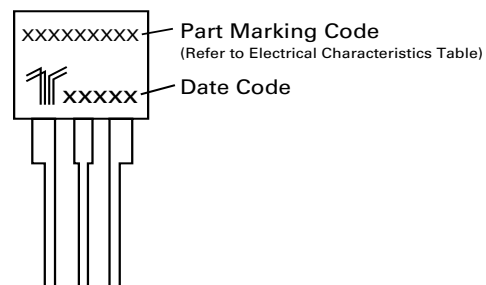

Additional Information



Datasheet



Resources



Samples

Dimensions - Modified TO-220

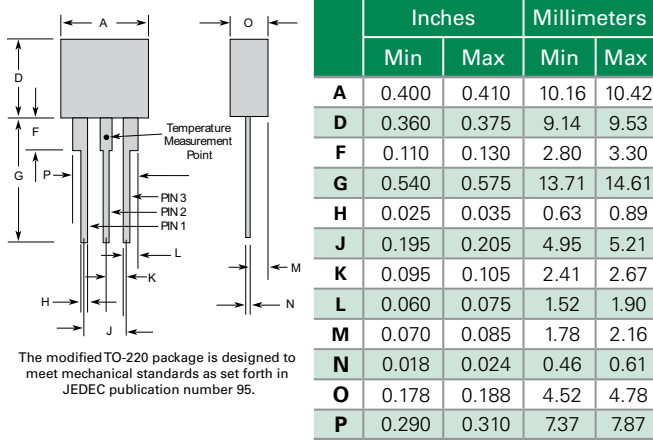

Dimensions - Modified TO-220 with Failsafe

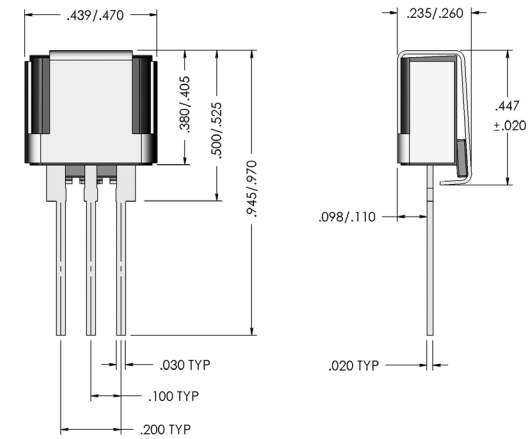

Tape and Reel Specification - Modified TO-220

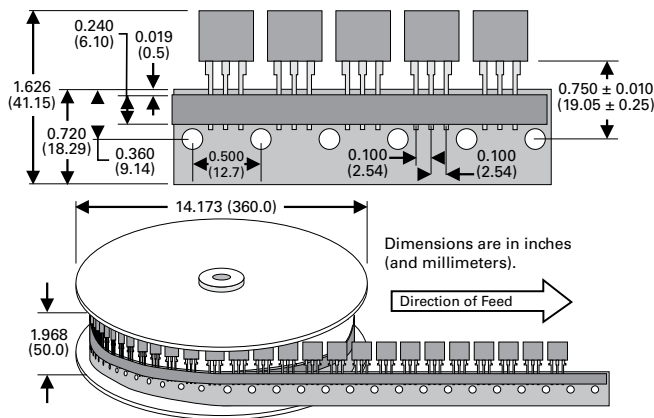

Dimensions - Modified TO-220 Type 60 with Failsafe

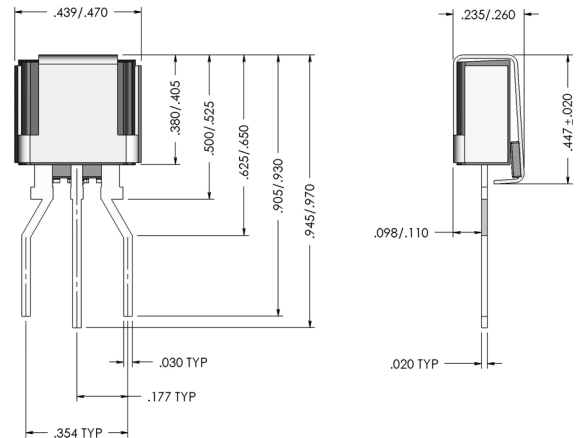

Packing Options

Package Type	Description	Quantity	Added Suffix	Industry Standard
A	Modified TO-220 Tape and Reel Pack	700	RP	EIA-468-B
	Modified TO-220 Bulk Pack	500	(no added suffix)	N/A
	Modified TO-220 Type 60 Lead Form Bulk Pack	500	60 (special order item, contact factory for details)	N/A

Disclaimer Notice - Information furnished is believed to be accurate and reliable. However, users should independently evaluate the suitability of and test each product selected for their own applications. Littelfuse products are not designed for, and may not be used in, all applications. Read complete Disclaimer Notice at www.littelfuse.com/disclaimer-electronics.