

Four-Terminal Surface Mount Resistor

AEC-Q200 Qualified > L4CA 0612 Series

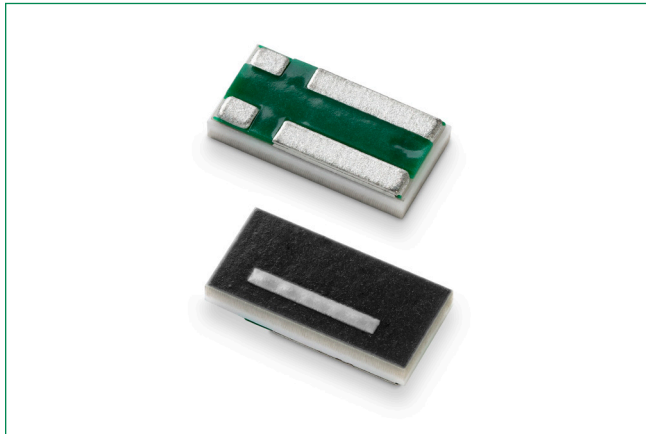

Description

Littelfuse L4CA Series Kelvin sensing, low resistance, high power chip resistors exhibit excellent performance in resistance, noise performance, surface heat distribution, and have a lower surface temperature.

Features

- Separate voltage sensing terminals
- Ceramic substrate
- AEC-Q200 Qualified

Benefits

- Small size
- High voltage

Additional Information



Resources



Accessories



Samples

Application

- Power management
- Low ESL
- Automotive

Electrical Specifications

Part Number	Size		Resistance		Power Rating (W)	TCR (ppm / °C)	Standard Package Qty
	Inch	mm	Ro (mΩ)	Rt (%)			
L4CA0612LR003FNR-A	0612	1632	3	±1.0%	1	±100	5000
L4CA0612LR004FNR-A	0612	1632	4	±1.0%	1	±100	5000
L4CA0612LR005FNR-A	0612	1632	5	±1.0%	1	±50	5000
L4CA0612LR006FNR-A	0612	1632	6	±1.0%	1	±50	5000
L4CA0612LR007FNR-A	0612	1632	7	±1.0%	1	±50	5000
L4CA0612LR008FNR-A	0612	1632	8	±1.0%	1	±50	5000
L4CA0612LR009FNR-A	0612	1632	9	±1.0%	1	±50	5000
L4CA0612LR010FNR-A	0612	1632	10	±1.0%	1	±50	5000
L4CA0612LR011FNR-A	0612	1632	11	±1.0%	1	±50	5000
L4CA0612LR012FNR-A	0612	1632	12	±1.0%	1	±50	5000
L4CA0612LR013FNR-A	0612	1632	13	±1.0%	1	±50	5000
L4CA0612LR014FNR-A	0612	1632	14	±1.0%	1	±50	5000
L4CA0612LR015FNR-A	0612	1632	15	±1.0%	1	±50	5000
L4CA0612LR016FNR-A	0612	1632	16	±1.0%	1	±50	5000
L4CA0612LR018FNR-A	0612	1632	18	±1.0%	1	±50	5000
L4CA0612LR020FNR-A	0612	1632	20	±1.0%	1	±50	5000
L4CA0612LR021FNR-A	0612	1632	21	±1.0%	1	±50	5000
L4CA0612LR022FNR-A	0612	1632	22	±1.0%	1	±50	5000
L4CA0612LR024FNR-A	0612	1632	24	±1.0%	1	±50	5000
L4CA0612LR025FNR-A	0612	1632	25	±1.0%	1	±50	5000

Note:

Resistors are available in steps of 1 mΩ. Ratings not indicated in the above table may be available on request.

Four-Terminal Surface Mount Resistor

AEC-Q200 Qualified > L4CA 0612 Series

Temperature De-rating Curve

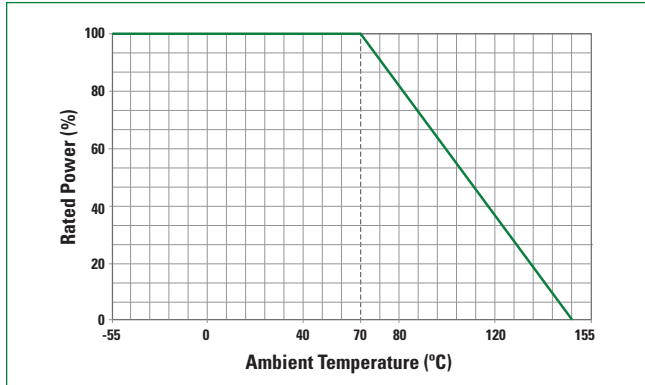

Storage / Environment Conditions

Products should be stored under the following environmental conditions.

Temperature	+5 to +35 °C
Humidity	45 to 85% relative humidity
Moisture Sensitivity Level	1, J-STD-020

Do not keep products in environments where they may be subject to particulate contamination or harmful gases such as sulfuric acid or hydrogen chloride as it may cause oxidization on electrodes, resulting poor solderability.

Products should be stored in a space that does not expose to high temperatures, vibration, or direct sunlight.

Products should be stored in the original airtight packaging until use.

Soldering Parameters–Wave Soldering

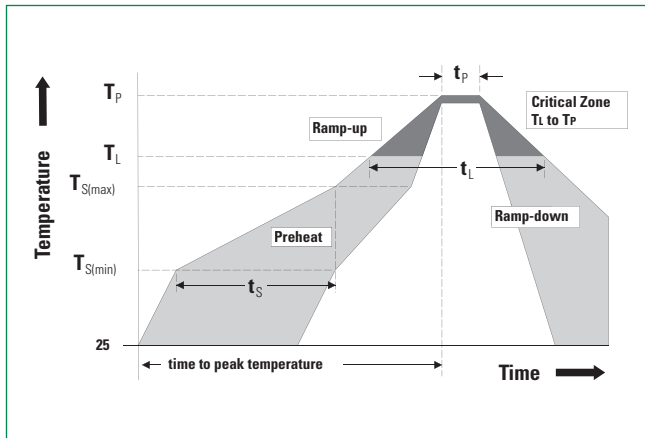

Profile Feature	Pb-Free Assembly
Average Ramp-Up Rate ($T_{S(max)}$ to T_P)	3 °C / second max
Preheat	
Temperature Minimum ($T_{S(min)}$)	150 °C
Temperature Maximum ($T_{S(max)}$)	200 °C
Time ($T_{S(min)}$ to $T_{S(max)}$)	60–180 seconds
Time maintained above	
Temperature Minimum (T_L)	217 °C
Time (t_L)	60–150 seconds
Peak Temperature (T_P)	260 ± 0 °C
Time within 5 °C of Actual Peak Temperature (t_p)	20–40 seconds
Ramp-Down Rate	6 °C / second Maximum
Time 25 °C to Peak Temperature	8 minutes Maximum

Four-Terminal Surface Mount Resistor

AEC-Q200 Qualified > L4CA 0612 Series

AEC-Q200 Reliability Specifications

Test	Procedure	Specifications
High Temp. Exposure (Storage) MIL-STD-202, Method 108	Test Temp 170 °C Test Period: 1,000 hours No Electrical Load	$\Delta R \leq \pm 1.0\%$
Temp. Cycling (Thermal Shock) JESD22 Method JA-104	Repeat 1,000 cycles as follows: -55 +/-3 °C for 30 minutes 155 +/-3 °C for 30 minutes Transition time of 1 minute max	$\Delta R \leq \pm 1.0\%$
Biased Humidity MIL-STD-202, Method 103	Test conditions: 85 °C and 85% RH 10% of rated power Test Period 1,000 hours	$\Delta R \leq \pm 1.0\%$
Load Life (Operational Life) MIL-STD-202, Method 108	Test Temperature: 125 +/-3 °C Applied voltage: rated power (derated Power will be required if temp exceeds the derating point of part) Test Period: 1,000 hours (condition D)	$\Delta R \leq \pm 1.0\%$
Resistance to Solvents MIL-STD-202, Method 215	3 minute soak, 2–3 ounce force, 10 strokes / repetition, 3 repetitions	No damage
Mechanical Shock MIL-STD-202, Method 213	Force: 100 G peak. Test duration: 6 ms, Half-sine waveform, Velocity: 12.3 ft / sec	$\Delta R \leq \pm 1.0\%$
Vibration MIL-STD-202, Method 204	Frequency: 10–2,000 Hz Acceleration: 5G Test duration: 20 minutes, 12 cycles	$\Delta R \leq \pm 1.0\%$
Resistance to Soldering Heat MIL-STD-202, Method 210	Condition B (Solder dip, no pre-heat) 260 °C	$\Delta R \leq \pm 1.0\%$
ESD AEC-Q200-002	HBM, 100 pF, 1.5 kΩ. Repetition: 5 times	$\Delta R \leq \pm 1.0\%$
Solderability J-STD-002	Non-activated flux dip: 5-10 seconds. SAC solder dip: 2 ± 0.5 seconds at 245 °C	95% coverage
Flammability UL-94	V-0 or V-1 are acceptable. Electrical test not required	V-0 burning less than 10 seconds V-1 burning less than 30 seconds
Board Flex AEC-Q200-005	90 mm span between fulcrums, 2 mm bend. 60 seconds minimum holding time	$\Delta R \leq \pm 1.0\%$
Terminal Strength (SMD) AEC-Q200-006	Force of 17.7 N 60 seconds	$\Delta R \leq \pm 1.0\%$
Flame Retardance AEC-Q200-001	Mounted parts subjected to voltages from 9.0 to 32 VDC (current clamped up to 500 A) in 1.0 VDC increments. Voltage applied for 1 hour minimum or until failure occurs	Must meet AEC-Q200 requirements

Four-Terminal Surface Mount Resistor

AEC-Q200 Qualified > L4CA 0612 Series

Dimensions

All dimensions in mm

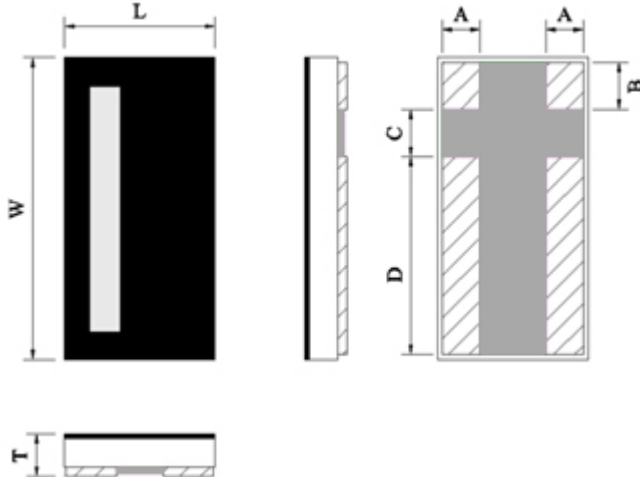

Part Number	W	L	T	D	C	B	A
L4CA0612-A	3.20±0.20	1.55±0.20)	0.50±0.20	2.16±0.20	0.50±0.20	0.46±0.20	0.41±0.20

Recommended Land Pattern

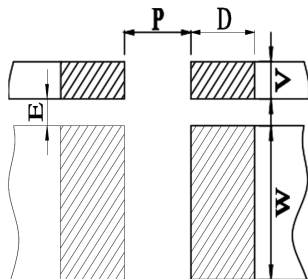

Part Number	P	W	D	V	E	Loading
L4CA0612-A	0.762 mm	2.29 mm	1.014 mm	0.762 mm	0.381 mm	1.0 W

Packaging

Part Number	Halogen Free	Packaging Option	Quantity	Quantity & Packaging Codes
L4CA0612-A	Yes	Tape and Reel	5000	NR

Four-Terminal Surface Mount Resistor

AEC-Q200 Qualified > L4CA 0612 Series

Part Numbering System

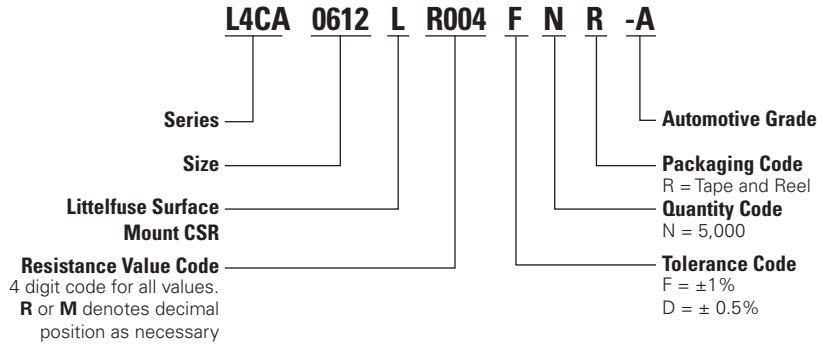

Tape and Reel Specifications

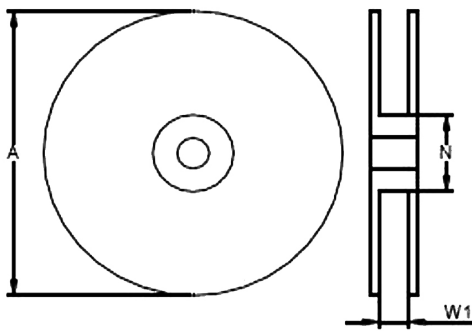

Part Number	A±5 (mm)	N±2 (mm)	W1±1 (mm)
L4CA0612-A	178	60	9.0

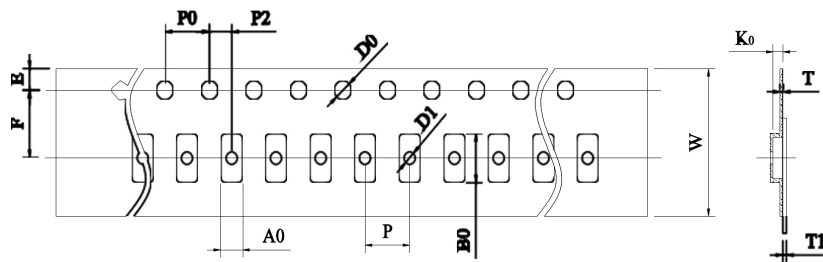

Part Number	W	P0	P	P2	A0	B0	D0	F	E	T	T1	K0
L4CA0612-A	8.00±0.30	4.00±0.10	4.00±0.10	2.00±0.10	1.90±0.20	3.50±0.20	1.50±0.10	3.50±0.10	1.75±0.10	0.20±0.10	Max. 0.1	0.85±0.20

Disclaimer Notice - Information furnished is believed to be accurate and reliable. However, users should independently evaluate the suitability of and test each product selected for their own applications. Littelfuse products are not designed for, and may not be used in, all applications. Read complete Disclaimer Notice at <http://www.littelfuse.com/disclaimer-electronics>.